

## SSMT Surface Mount Interconnect System

### Microminiature Surface Mount RF Connectors

#### Product Facts

- 3.0 [.118] mated height
- Excellent interface retention
- Flexible micro-coax cable
- 360 degree mated rotation
- Tape and Reel packaging available

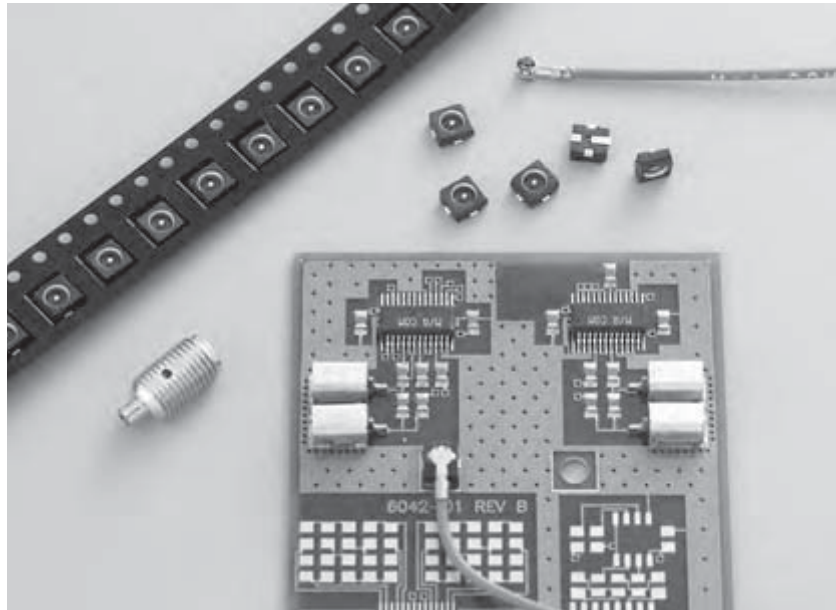

The Tyco Electronics SSMT surface mount Interconnect System is designed to provide superior electrical and mechanical performance for wireless communication applications. The SSMT system occupies less printed circuit board (PCB) real estate than conventional through hole coaxial connectors. An innovative microstrip mounting pattern and plug receptacle design ensure reliable grounding and PCB retention characteristics. The SSMT Interconnect System allows closer pitch/spacing, standing 3.0 [.118] (fully mated height) off the board. The mated SSMT interface allows 360 degrees of rotation providing maximum PCB design flexibility. It has been designed to provide optimal retention for

applications where shock, vibration or cable flexure may be encountered. Force to disengage by cable load (cam-out) exceeds 300 grams.

The SSMT system is designed to provide the performance of much larger industry standard connectors. The SSMT Interconnect System consistently achieves broad band electrical performance through 6 GHz with a maximum VSWR of 1.20:1 at 2 GHz. This broad band performance establishes a reliable interface that can be utilized for future system upgrades without concern for performance degradation.

The SSMT utilizes a common plug receptacle, part number 1251802-1, which is designed for high volume

assembly using surface mount technology and is available in tape and reel packaging for automatic pick and place board assembly. The mating cable jack is available terminated to a highly flexible micro-coax cable as either a pigtail, jumper or standard interseries connector assembly to meet your needs.

The SSMT Interconnect System can be manually mated, facilitating high volume assembly and eliminating the need for special engagement tooling. The SSMT interface design aligns the center contacts prior to full mating to ensure a robust mechanical engagement. Interface durability is rated at 100 mating cycles.

## SSMT Surface Mount Interconnect System (Continued)

### Specifications

#### General

##### Materials

SMT Plug	Housing: Contacts:	Polyphenylene Sulfide (PPS) Copper Alloy
SSMT Cable Jack	Outer Contact: Inner Contact: Dielectric:	Beryllium Copper Beryllium Copper Polypropylene, GF
Finish	Plug and cable jack - Contacts: Gold plate over nickel plate	

#### Electrical

Frequency	dc - 6 GHz
Nominal Impedance	50 Ohms
Voltage Rating	250 Volts (VRMS Maximum) @ Sea Level
VSWR (Mated Pair)	1.20:1 Maximum @ 2 GHz 1.40:1 Maximum @ 6 GHz
Insulation Resistance	5000 Megohms Minimum
Dielectric Withstanding Voltage	500 Volts (VRMS Minimum) @ Sea Level
Contact Resistance (Connectors Only)	
Center Contact	15 milliohms Maximum
Outer Contact	10 milliohms Maximum
Insertion Loss (Connectors Only)	.15dB Max. @ 6 GHz

#### Mechanical

Connector Durability	100 mating cycles
Tape/Reel Packaging (Plug)	12mm per EIA-481
Force to Engage	5.5 lbs. Max. (3.5 lbs. typ.)
Force to Disengage	(2.0 lbs. typ.) 4.0 lbs. Max. (2.0 lbs. typ.)
Force to Disengage by Cable Load (camout)	300 Grams Min. (800 Grams typ. initial mate)

#### Environmental

Temperature Rating (Mated Pair)	-40°C (-40°F) to +125°C (257°F)
Resistance to Solder Heat	Infrared, convection and vapor phase solderable (plug only). Maximum reflow time/temperature not to exceed 260°C for 3 minutes.

#### Cable Specifications

##### Materials

Jacket:	FEP (polytetrafluoroethylene)
Shield:	Silver plated copper wire, 44 AWG, 90% min. coverage
Dielectric:	PTFE ( polytetrafluoroethylene)
Center Conductor:	Silver plated copper clad steel, 30 AWG
Minimum Bend Radius	6.35mm (.250 inch)
Insertion Loss (Cable Only)	0.5 dB/ft., 2.0 dB/m @ 1 GHz 0.9 dB/ft., 3.0 dB/m @ 2 GHz
Center Conductor Resistance	.25 Ohms per foot average. 819 milliohm/meter Nom.; 250 milliohm/Ft. Nom.

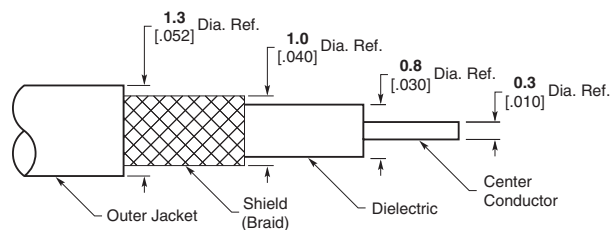



**SSMT Surface Mount Interconnect System** (Continued)

**Right-Angle Jack to Jack  
Cable Assembly  
(180° Offset)**

Assembly Length (A)	Part No.
100 [4.0]	1082845-1

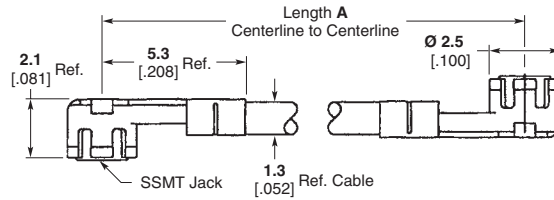

Notes:

1. Consult Tyco Electronics for non-standard cable lengths.  
Cable length tolerance:

Length A Tolerances.

Length A	Tolerance
50 To 100 [3.94]	± 3 [± .12]
101 To 500 [3.98 to 19.69]	± 5 [± .20]
Over 500 [19.69]	± 10 [± .39]

2. To avoid damaging the cable, minimize time at temperature while soldering and/or applying heat to unterminated end of cable.

**Right-Angle Jack Cable  
Pigtail**

Assembly Length (A)	Part No.
100 [4.0]	1064535-1
200 [8.0]	1064538-1
305 [12.0]	1064540-1
510 [20.0]	1064542-1

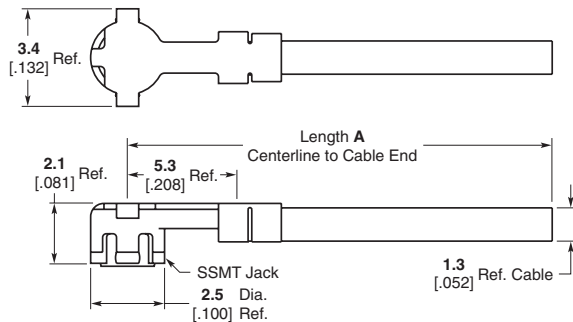

Notes:

1. Consult Tyco Electronics for non-standard cable lengths.  
Cable length tolerance:

Length A Tolerances.

Length A	Tolerance
50 To 100 [3.94]	± 3 [± .12]
101 To 500 [3.98 to 19.69]	± 5 [± .20]
Over 500 [19.69]	± 10 [± .39]

2. To avoid damaging the cable, minimize time at temperature while soldering and/or applying heat to unterminated end of cable.

**Note:** Part Numbers are RoHS compliant except: ♦ Indicates non-RoHS compliant.

**SSMT Surface Mount Interconnect System** (Continued)

**Inter-Series Cable Assemblies**



Notes:

1. Consult Tyco Electronics for non-standard cable lengths:  
Length A Tolerances.

Length A	Tolerance
50 To 100 (3.94)	± 3 (± .12)
101 To 500 (3.98 to 19.69)	± 5 (± .20)
Over 500 (19.69)	± 10 (± .39)

2. Connectors are randomly aligned unless otherwise noted.

**SMA Straight Plug**

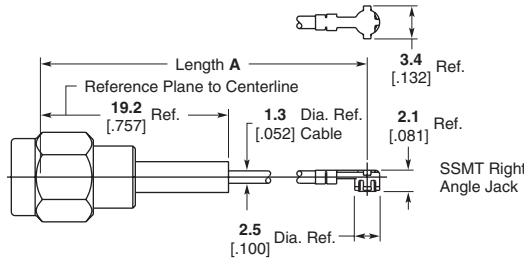

Assembly Length (A)	Part No.
100 [4.0]	1064543-1
200 [8.0]	1064552-1
305 [12.0]	1064560-1

Note:  
1064552-1 recommended for customer system verification.

**SMA Bulkhead Jack**

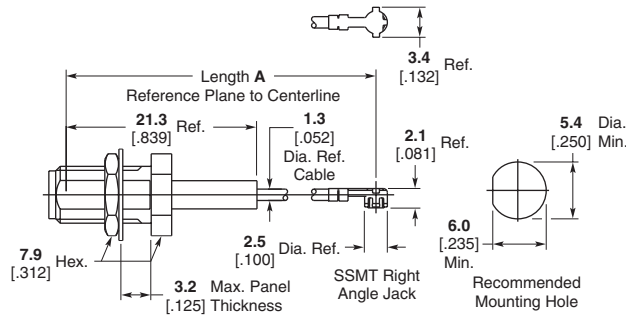

Assembly Length (A)	Part No.
100 [4.0]	1064544-1
200 [8.0]	1064553-1
305 [12.0]	1064561-1

**SMB Bulkhead Jack**

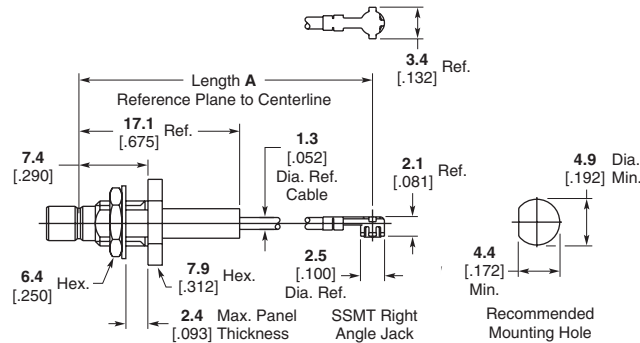

Assembly Length (A)	Part No.
100 [4.0]	1064546-1
200 [8.0]	1064555-1
305 [12.0]	1064563-1

**Note:** Part Numbers are RoHS compliant except: ♦ Indicates non-RoHS compliant.

**SSMT Surface Mount Interconnect System** (Continued)

**Inter-Series Cable Assemblies** (Continued)

**MCX Bulkhead Jack**

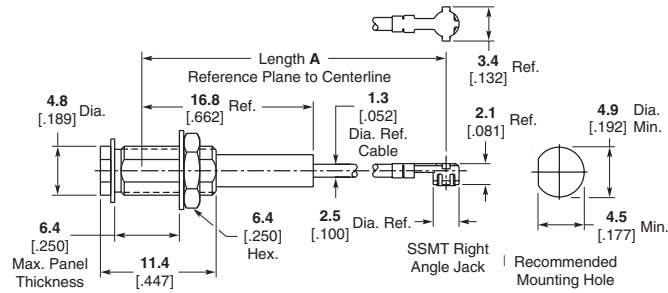

Assembly Length (A)	Part No.
100 [4.0]	1064549-1
200 [8.0]	1064558-1
305 [12.0]	1064566-1

**MCX Right-Angle Plug**

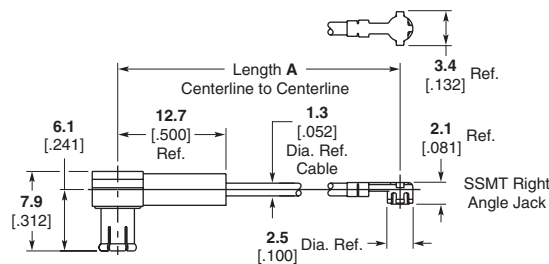

Assembly Length (A)	Part No.
100 [4.0]	1064550-1
200 [8.0]	1064559-1
305 [12.0]	1064567-1

**SSMT Disengagement Tool**

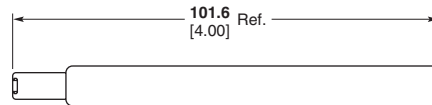

Part No.
1221286-1

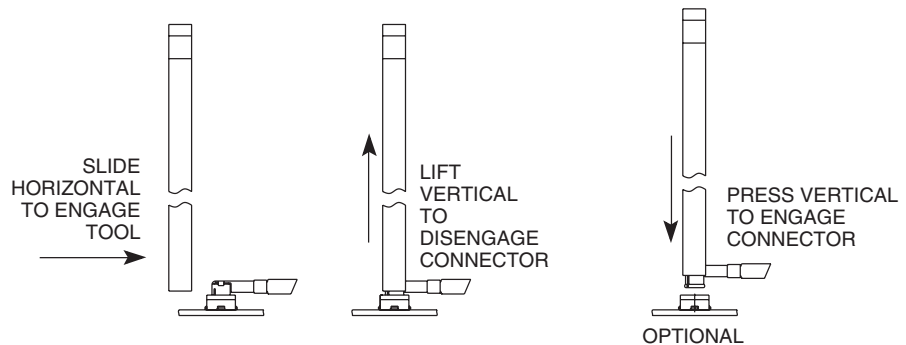

**Use of Engagement/Disengagement Tool**

Note: The SSMT disengagement tool can be utilized as an optional engagement tool versus manual hand installation.

**SSMT to SMA Between Series Adapters**

**SSMT Plug to SMA Jack Adapter**

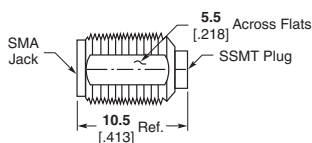

Part No. 1055696-1

**SSMT Plug to SMA Plug Adapter**

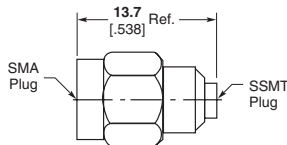

Part No. 1055695-1

**SSMT Jack to SMA Jack Adapter**

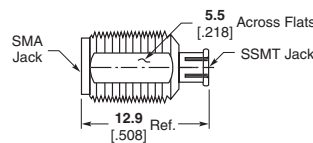

Part No. 1055694-1

**SSMT Jack to SMA Plug**

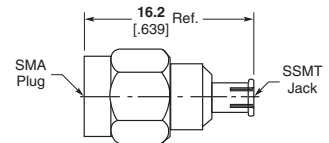

Part No. 1055697-1

**Note:** Part Numbers are RoHS compliant except: ♦ Indicates non-RoHS compliant.