

PROPER USE GUIDELINES

Cumulative Trauma Disorders can result from the prolonged use of manually powered hand tools. Hand tools are intended for occasional use and low volume applications. A wide selection of powered application equipment for extended-use, production operations is available.

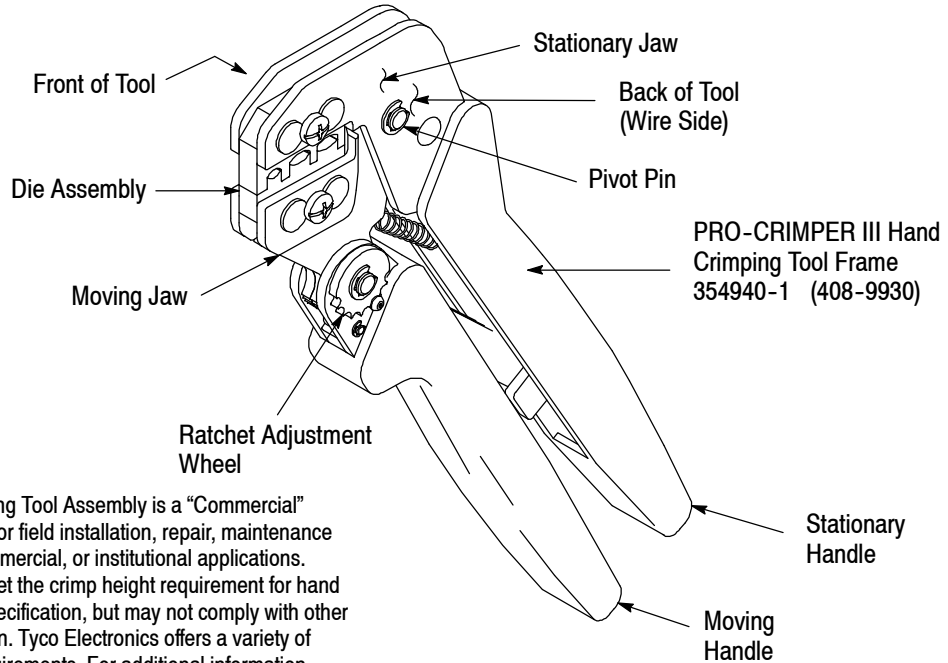

The PRO-CRIMPER III Hand Crimping Tool Assembly is a “Commercial” grade tool and is designed primarily for field installation, repair, maintenance work, or prototyping in industrial, commercial, or institutional applications. Product crimped with this tool will meet the crimp height requirement for hand tools in the appropriate 114 series specification, but may not comply with other feature parameters of the specification. Tyco Electronics offers a variety of tools to satisfy your performance requirements. For additional information, contact the Tooling Assistance Center at 1-800-722-1111.

TE Die Assembly	Product Family‡	Size (AWG)	Wire				Strip Length (mm [in.])
			Insulation Diameter (Max) (mm [in.])				
			for Receptacle Series Size				
			110 and 125		187 and 250		
		Standard	Large	Standard	Large		
58628-2	Ultra-Fast FASTON* Straight Receptacle	26-22	2.54 [.100]	—	—	—	7.14±0.41 [.281±.016]
		22-18	3.05 [.120]	5.84 [.230]	3.43 [.135]	5.84 [.230]	
		16-14	—	6.60 [.260]	4.06 [.160]	6.60 [.260]	

‡ Contact the Tooling Assistance Center or Product Information (at the numbers listed below) for specific receptacle part numbers.

Figure 1

1. INTRODUCTION

PRO-CRIMPER III Hand Crimping Tool Assembly 58628- 1 consists of Die Assembly 58628-2 and PRO-CRIMPER III Hand Crimping Tool Frame 354940-1. The tool is used to crimp the receptacles onto the wire sizes listed in Figure 1.

Read these instructions thoroughly before crimping

any receptacles.

If these instructions are revised, reasons for revision will be listed in Section 9, REVISION SUMMARY.

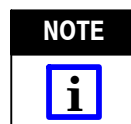

Dimensions on this sheet are in millimeters [with inch equivalents provided in brackets]. Figures are for identification only and are not drawn to scale.

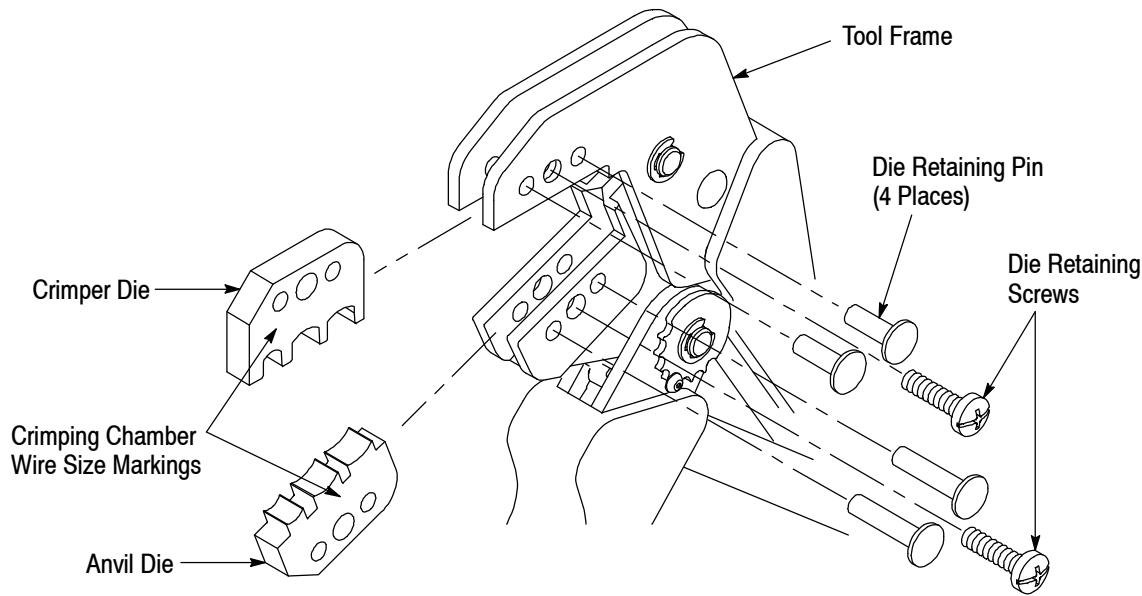

Figure 2

2. DESCRIPTION (Figures 1 and 2)

The tool features a tool frame with a stationary jaw and handle, a moving jaw, a moving handle, and an adjustable ratchet that ensures full crimping. The tool frame holds a die assembly with three crimping chambers.

The die assembly features an anvil die and a crimper die. Die retaining pins and die retaining screws are used to position and secure the dies in the tool frame.

3. INSTALLATION AND REMOVAL OF DIE ASSEMBLY (Figure 2)

1. Open the tool handles and remove the two die retaining screws from the tool jaws.
2. Place the anvil die so that the chamfered edge faces outward when mounted in the moving jaw of the tool frame. Place the crimper die so that the chamfered edge faces outward when mounted in the stationary jaw.
3. Insert the die retaining screws and die retaining pins through each jaw and into each die. Tighten the die retaining screws just enough to hold the dies in place. Do *not* tighten the screws completely at this time.
4. Carefully close the tool handles, making sure that the anvil die and crimper die align properly. Continue closing the tool handles until the ratchet in the tool frame has engaged sufficiently to hold the dies in place, then tighten both die retaining screws.

5. To disassemble, open the tool handles, remove the four die retaining pins and two die retaining screws, and slide the dies out of the tool jaws.

4. CRIMPING PROCEDURE

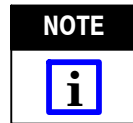

Initially, the crimping chambers and tool ratchet should be inspected as specified in Section 5, CRIMP HEIGHT INSPECTION, and Section 6, RATCHET ADJUSTMENT, to verify reliability before using the tool.

Refer to Figure 1 and select wire of the specified size. Strip the wire to the length indicated, taking care not to nick or cut wire strands. Select an applicable receptacle and identify the appropriate crimping chamber according to the wire size markings on the dies. Refer to Figure 3 and proceed as follows:

1. Squeeze tool handles together until the ratchet releases and then allow the tool jaws to open fully.
2. Insert the receptacle (mating end first) into the BACK of the tool in the appropriate crimping chamber so that the flat side of the receptacle faces the anvil die. Make sure that the wire barrel is centered in the crimping chamber.
3. Hold the receptacle in position and squeeze the tool handles together until ratchet engages sufficiently to hold the receptacle in position. Do NOT deform the wire barrel.
4. Insert the stripped wire into the wire barrel of the receptacle.
5. Holding the wire in place, squeeze tool handles together until ratchet releases. Allow tool handles to open and remove crimped receptacle.

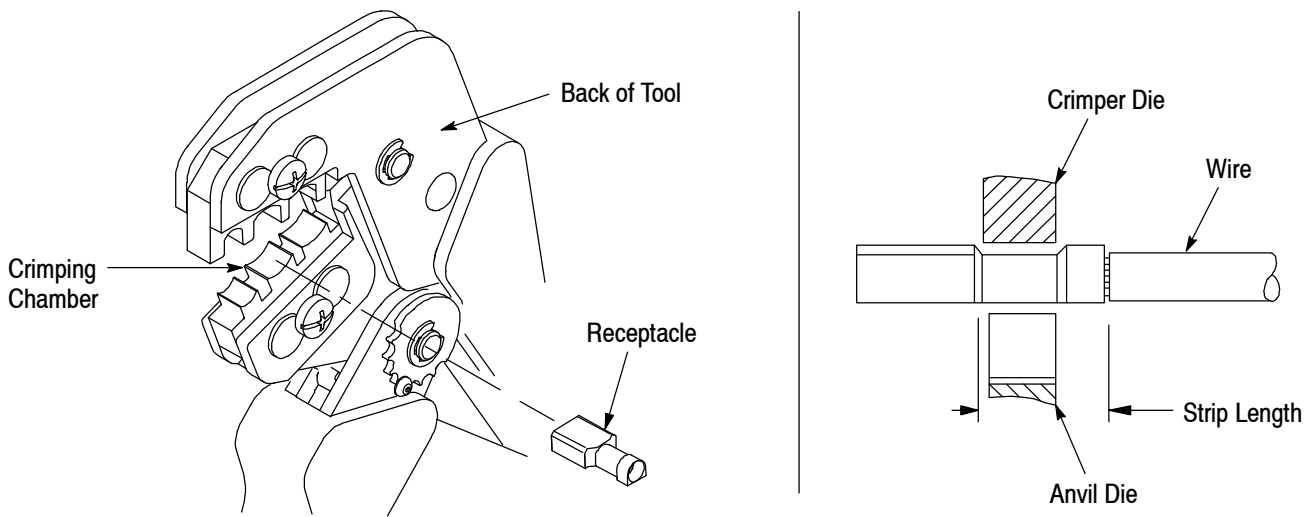

Figure 3

6. Inspect the crimped receptacle to ensure that the crimp is centered on the wire barrel and the wire is fully inserted. Check the receptacle crimp height as described in Section 5. If necessary, adjust the crimp height as described in Section 6.

5. CRIMP HEIGHT INSPECTION

This inspection requires the use of a plug gage conforming to the dimensions provided in Figure 4. Tyco Electronics does not manufacture or market these gages. To gage the crimping chambers, proceed as follows:

NOTE Refer to 408-7424 for information about the use and ordering of plug gages and crimp-height comparators.

1. Remove traces of oil or dirt from crimping chambers and plug gages.
2. Close the tool handles until it is evident that the dies have bottomed; hold the tool in this position. Do NOT force the dies beyond initial contact.
3. Carefully insert GO element straight into the corresponding crimping chamber; do not force it. The GO element must pass completely through the crimping chamber. See Figure 4.
4. In the same manner, try to insert the NO-GO element into the same crimping chamber. The NO-GO element may start entry, but must not pass completely through the crimping chamber.

If the crimping chambers conform to the gage inspection, they are considered dimensionally correct, and should be lubricated with a THIN coat of any

good SAE 20 motor oil. If not, the tool must be adjusted according to Section 6, CRIMP HEIGHT ADJUSTMENT.

Suggested Plug Gage Design

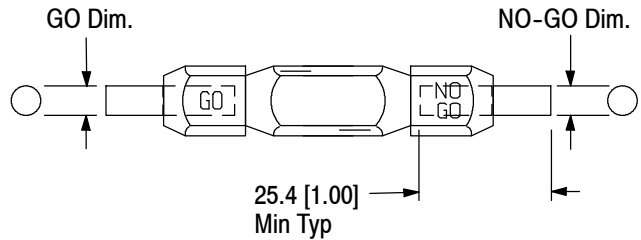

Crimping Chamber	Gage Element Dimensions (mm [in.])	
	GO	NO-GO
26-22	1.4732-1.4808 [.0580-.0583]	1.5723-1.5748 [.0619-.0620]
22-18	1.6002-1.6078 [.0630-.0633]	1.6993-1.7018 [.0669-.0670]
16-14	1.8542-1.8618 [.0730-.0733]	1.9532-1.9558 [.0769-.0770]

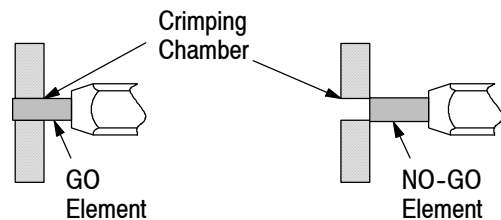

Figure 4

6. RATCHET (Crimp Height) ADJUSTMENT (Figure 5)

1. Remove the lock screw from the ratchet adjustment wheel.
2. With a screwdriver, adjust the ratchet wheel from the front of the tool.
3. Observe the ratchet adjustment wheel. If a tighter crimp is required, rotate the adjustment wheel *counterclockwise* to a higher-numbered setting. If a looser crimp is required, rotate the adjustment wheel *clockwise* to a lower-numbered setting.
4. Re-assemble the lock screw.
5. Make a sample crimp and measure the crimp height. If the dimension is acceptable, the adjustment setting is correct. If the dimension is unacceptable, continue to adjust the ratchet, and again measure a sample crimp.

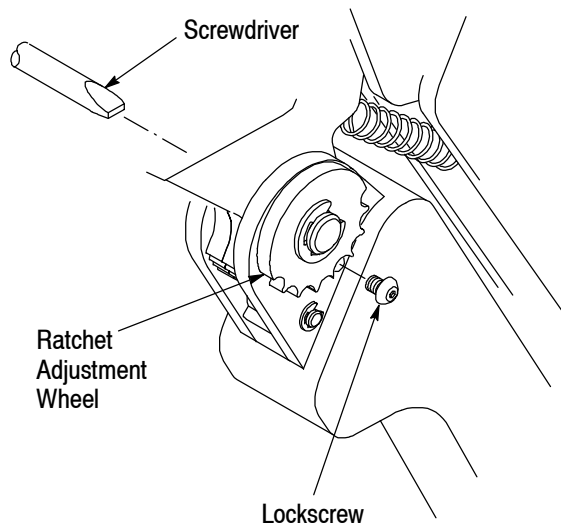

Figure 5

7. MAINTENANCE AND INSPECTION**7.1. Maintenance**

Ensure that the tool and dies are clean by wiping them with a clean, soft cloth. Remove any debris with a clean, soft brush. Do not use objects that could damage the tool. When not in use, keep handles closed to prevent objects from becoming lodged in the crimping dies, and store in a clean, dry area.

7.2. Visual Inspection

The crimping dies should be inspected on a regular basis to ensure that they have not become worn or

damaged. Inspect the crimping sections for flattened, chipped, worn, or broken areas. If damage or abnormal wear is evident, the tool must be replaced. See Section 8, REPLACEMENT.

8. REPLACEMENT

Customer-replaceable parts are shown in Figure 1.

Available separately, PRO-CRIMPER III Hand Crimping Tool Repair Kit 679221-1 includes a replacement nut and a variety of pins, rings, screws, and springs.

If the dies are damaged or worn excessively, they must be replaced.

Order the repair kit and replaceable parts through your Tyco Electronics representative, or call 1-800-526-5142, or send a facsimile of your purchase order to 717-986-7605, or write to:

CUSTOMER SERVICE (38-35)
 TYCO ELECTRONICS
 PO BOX 3608
 HARRISBURG PA 17105-3608

9. REVISION SUMMARY

Revisions to this instruction sheet include:

- PRO-CRIMPER II Hand Tool changed to PRO-CRIMPER III Hand Tool;
- Applied the TE logo; and
- Updated format to the current corporate requirements.