

TOSHIBA C²MOS DIGITAL INTEGRATED CIRCUIT SILICON MONOLITHIC

TCM9001MD

V0.21

Dec 12, 2008

Preliminary

1/10" VGA size Camera Module

Features

General

- Input Clock : 9.0 to 26MHz (with PLL, selectable)
- Frame rate : 30fps (max.) @VGA output
- Data formats : YUV422/RAW
- Output format : Parallel output
- Power supply : Analog 2.8V -/+ 0.2V
Digital 1.8V -/+ 0.1V
I/O 1.8V -/+0.1V or 2.8V -/+0.2V
- Operating temperature : -20 to +60 degree C
- Storage temperature : -30 to +85 degree C

Sensor

- Optical format : 1/10 inch
- Effective pixel numbers : 648(H) x 492(V)
- Pixel pitch : 2.2 μ m(H) x 2.2 μ m(V) (square pixel)
- Image area size : 1425.6 μ m(H) x 1082.4 μ m(V)
- Color filter : Primary color filter, Bayer arrangement
- Image sizer and window of interest (QVGA, QQVGA)
- Picture flip (Horizontal flip and Vertical flip)
- Picture effects (monochrome, negative, sepia, sketch, emboss)
- Fixed output format (VGA, QVGA, QQVGA)
- Auto luminance control (=Auto exposure)
- Auto white balance
- Blemish correction
- Auto flicker detection and correction
- Gamma correction
- Lens shading correction
- Power down mode for low power consumption

Key Specifications

Item	Contents
Optical format	1/10 inch
Effective pixel numbers	648(H) x 492(V)
Image area size	1425.6 μ m(H) x 1082.4 μ m(V)
Pixel pitch	2.2 μ m(H) x 2.2 μ m(V)
Aspect ratio	4(H) : 3(V)
Input clock frequency range	9 to 26 MHz (with PLL, selectable)
Signal output order	Progressive scanning
Color filter	RGB primary color filter Bayer arrangement (G checked, R/B in line sequence)
Output data	YUV422 or RAW parallel output
Frame rate	30fps (max.) @ VGA
Package	Camera Module

Table 1 Key specifications

Table of Contents

Features.....	1
General.....	1
Sensor	1
Key Specifications.....	2
Table of Contents.....	3
1. List of Abbreviation.....	5
2. Block Diagram.....	6
2.1. Block Diagram.....	6
2.2. I/O circuits.....	7
3. Pin Layout	8
4. I ² C Control Interface.....	9
4.1. General.....	9
4.2. Slave address.....	10
5. Power supply	11
6. Input clock frequency	12
6.1. Clock setting.....	12
7. Frame rate.....	12
8. Data Formats	12
9. Functions	13
9.1. Window of interest	13
9.2. Image sizer.....	13
9.3. Picture flip	13
9.4. Picture effects	13
9.5. Dynamic range adjustment	13
9.6. Gamma correction.....	13
9.7. Auto luminance control	14
9.8. Analog gain control.....	14
9.9. White balance	14
9.10. Auto flicker detection and correction	14
9.11. Statistical data output.....	14
9.12. Color separation.....	14
9.13. Color matrix	14
9.14. Edge enhancement	14
9.15. Brightness and contrast	15
9.16. Lens shading correction	15
9.17. Blemish correction	15
9.18. Test charts.....	15
9.19. Test pattern output.....	15
10. Timing Chart	16
10.1. Power management modes.....	16
10.2. Power on/off sequence	17
10.2.1. Power on sequence (w/ built-in regulator).....	17
10.2.2. Power off sequence (w/ built-in regulator)	17
10.3. Output signal waveform	18
11. Register descriptions	19

12. Electrical Characteristics	31
12.1. Absolute Maximum Ratings.....	31
12.2. Operating Conditions.....	31
12.3. DC Characteristics.....	32
12.4. AC Characteristics.....	33
12.4.1. EXTCLK input conditions	33
12.4.2. SDA and SCL.....	34
12.4.3. DATA7 to DATA0, DCLK, HSYNC and VSYNC	35
13. Reference of Application Circuit	36
14. Characteristics of Lens.....	37
15. Module dimensions	38
16. Instruction for the Camera Module handling.....	39
RESTRICTIONS ON PRODUCT USE	39
Revision History.....	40

1. List of Abbreviation

Abbreviation	Description
ISP	Image Signal Processor
CDS	Correlated Double Sampling
ADC	Analog to Digital Converter
PLL	Phase Locked Loop
VCO	Variable Controlled Oscillator
PPRO	Pre PROcessor
MPRO	Main PROcessor
APRO	After signal PROcessor
ALC	Auto Luminance Control (≒AE)
AE	Auto Exposure
AF	Auto Focus
UXGA	Ultra XGA (1600 x 1200)
SXGA	Super XGA (1280 x 1024)
Quad VGA	Quad VGA (1280 x 960)
XGA	eXtended Graphics Array (1024 x 768)
SVGA	Super VGA (800 x 600)
VGA	Video Graph Array (640 x 480)
CIF	Common Intermediate Format (352 x 288)
QVGA	Quarter VGA (320 x 240)
QCIF	Quarter CIF (176 x 144)
QQVGA	Quarter Quarter VGA (160 x 120)
subQCIF	subQCIF (128 x96)
Image area	Aperture area of the sensor
Effective pixel area	It is the pixel area that is the signal output is available.

Table 2 Abbreviation

2. Block Diagram

2.1. Block Diagram

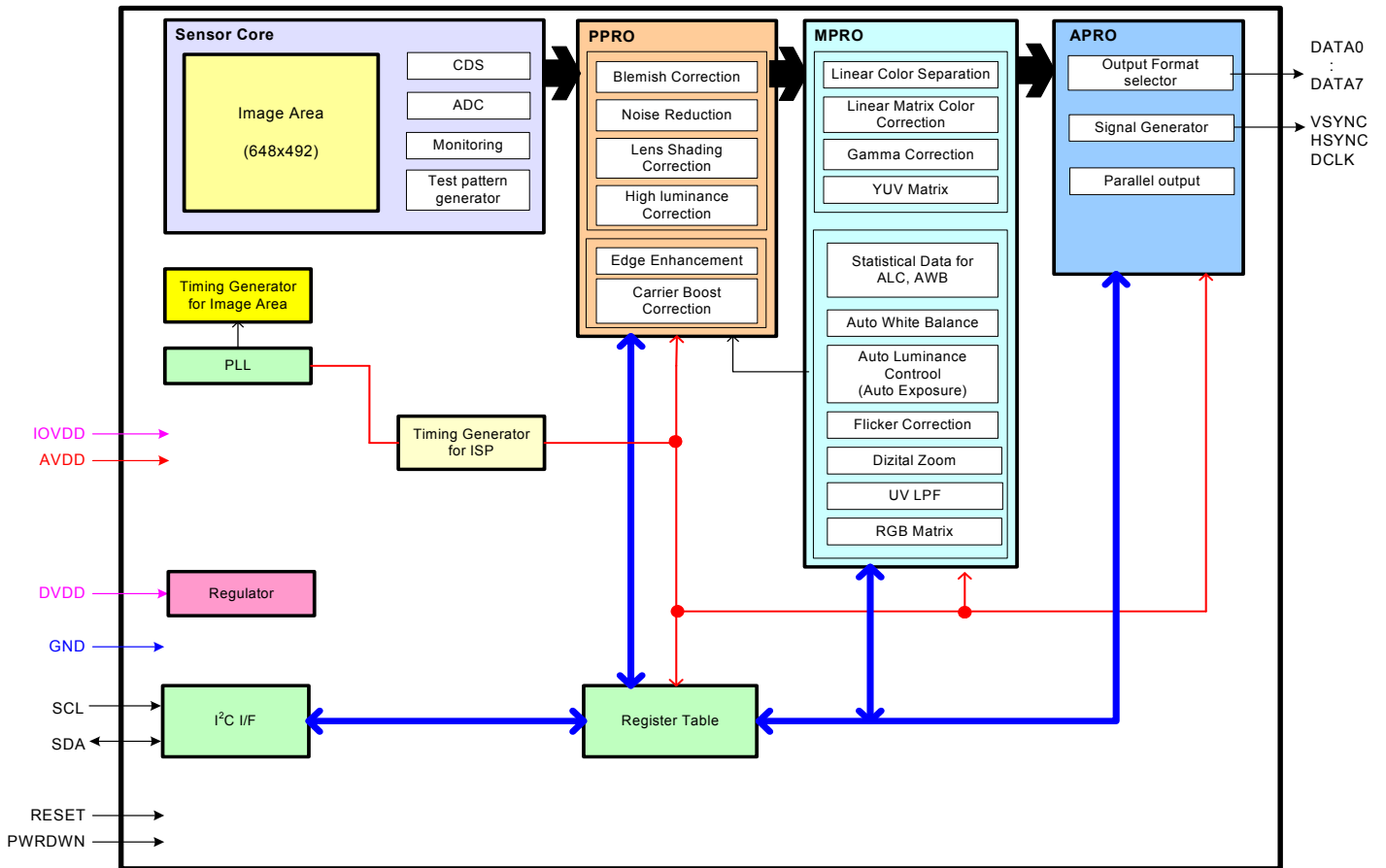

Some functional blocks, circuits or constants may be omitted or simplified in the block diagram for explanatory purposes.

Figure 1 Block diagram

2.2. I/O circuits

Pin No. / Pin name	I/O	Interface circuit
B5: EXTCLK	I	
C6: PWRDWN	I	
D3: RESET	I	
D6: SCL	I	
C5: SDA	I/O	
A3: DCLK D1: HSYNC D2: VSYNC B1: DATA1 B2: DATA2 B3: DATA0 B4: DATA3 C1: DATA4 C2: DATA5 C3: DATA6 D4: DATA7	O	

The equivalent circuit diagrams may be simplified or some parts of them may be omitted for explanatory purposes.

Table 3 I/O circuits

3. Pin Layout

<Top view>

Orientation

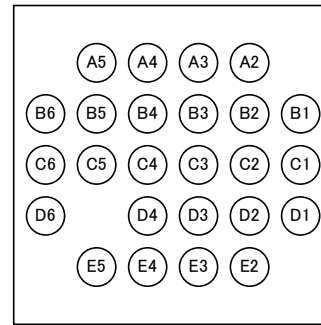
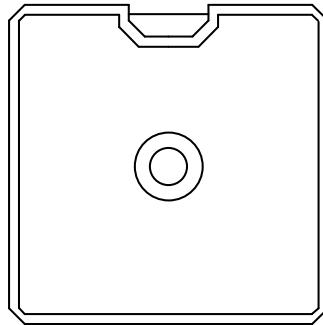

Pin No.	Pin name	I/O	Description
A2	IOVDD	-	Power supply for I/O circuits (1.7 to 3.0V)
A3	DCLK	O	Data clock output
A4	GND	-	System ground
A5	VDD15	-	Capacitor connection for internal regulator
B1	DATA1	O	Image data output 1
B2	DATA2	O	Image data output 2
B3	DATA0	O	Image data output 0
B4	DATA3	O	Image data output 3
B5	EXTCLK	I	External clock input
B6	DVDD	-	Power supply for digital circuits (1.8V +/- 0.1V)
C1	DATA4	O	Image data output 4
C2	DATA5	O	Image data output 5
C3	DATA6	O	Image data output 6
C4	GND	-	System ground
C5	SDA	I/O	Serial data input/output for I ² C
C6	PWRDWN	I	System power down signal input
D1	HSYNC	O	Horizontal synchronization signal output
D2	VSNC	O	Vertical synchronization signal output
D3	RESET	I	System reset signal input (Reset = L)
D4	DATA7	O	Image data output 7
D6	SCL	I	Serial data input/output for I ² C
E2	GND	-	System ground
E3	GND	-	System ground
E4	VDD15	-	Capacitor connection for internal regulator
E5	AVDD	-	Power supply for analog circuits (2.8V +/- 0.2V)

Install the product correctly. Otherwise, it may result in break down, damage and/or degradation to the product or equipment.

Table 4 Pin description

4. I²C Control Interface

TCM9001MD controls interface configuration is based on fast mode I²C bus.
 Register setting can be changed via I²C bus. All register settings are readable via I²C bus.

4.1. General

Write mode

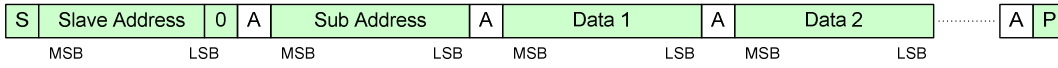

Read mode (Standard format)

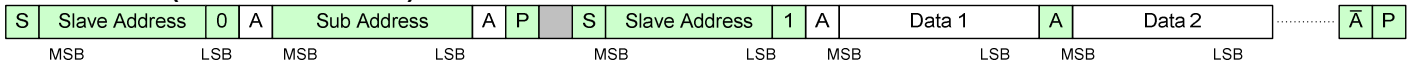

Read mode (Combination format)

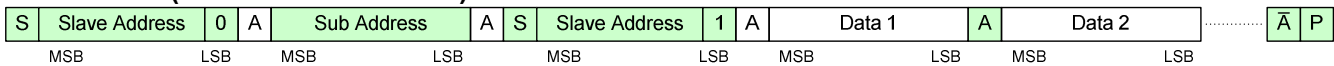
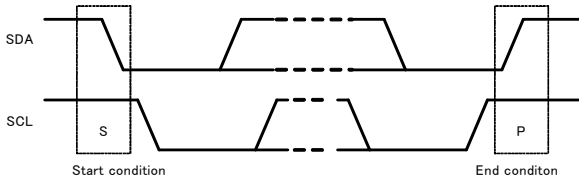
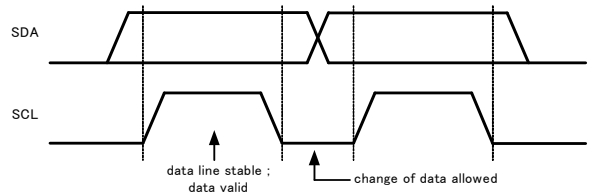

Figure 2 Write/Read mode

Start condition, End condition



Bit Transfer



Acknowledge

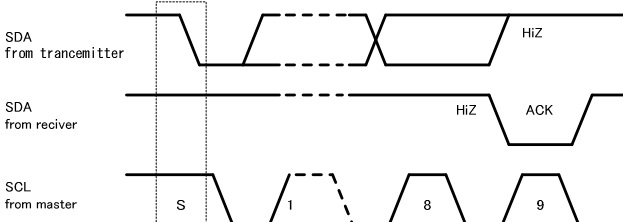

Not Acknowledge

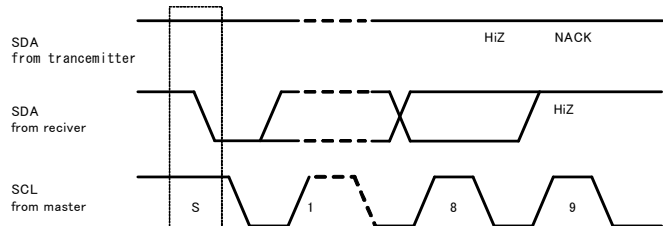

Figure 3 Start/End condition

Note:

The system conforms to the I²C Standard Specification as defined by Philips.

4.2. Slave address

TCM9001MD has one address table. Slave address is 7Ch.

W : 7Ch

R : 7Dh

Bit	Data
A6	0
A5	1
A4	1
A3	1
A2	1
A1	1
A0	0
R/W	1/0

Table 5 Slave address

5. Power supply

TCM9001MD needs two power supplies, 2.8V and 1.8V. 2.8V is for Analog and 1.8V is for the build-in regulator (for Analog and digital circuits). And IOVDD also require a power supply, 1.8V or 2.8V, for I/F.

Pin name	I/O	Description
AVDD	-	Power supply for analog circuits (2.8V \pm 0.2V)
IOVDD	-	Power supply for I/O circuits (1.8V \pm 0.1V or 2.8V \pm 0.2V)
DVDD	-	Power supply for regulator (1.8V \pm 0.1V)

Table 6 Power supply pins

6. Input clock frequency

The input clock frequency between 9MHz and 26MHz is acceptable to TCM9001MD.

6.1. Clock setting

The clock system diagram is shown below.

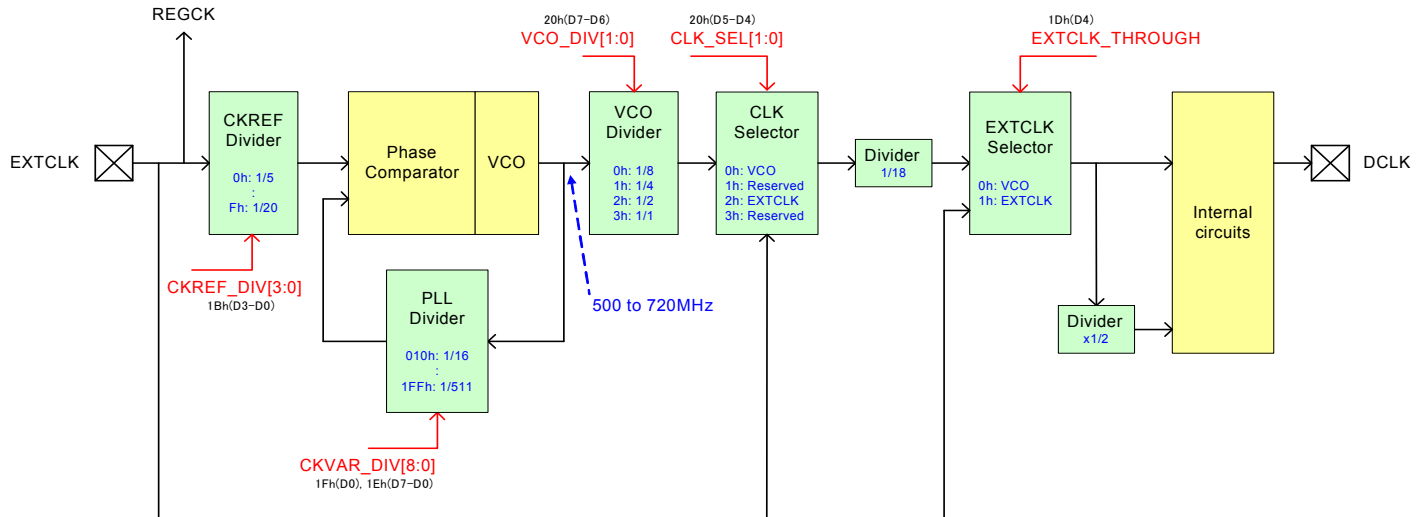

Some functional blocks, circuits or constants may be omitted or simplified in the block diagram for explanatory purposes.

Figure 4 Clock diagram

7. Frame rate

TCM9001MD can operate 30 fps or less in VGA output mode.

8. Data Formats

The following data formats are available. Data format is selectable by I²C commands. The data output supports parallel.

Available parallel output: YUV422 and Raw

9. Functions

9.1. Window of interest

The window of interest function enables the user to select a part of the image from the whole image area with specified location (2 pixel step) and specified size (8 pixel step). The available maximum size is 648 x 492 in RAW output or 640 x 480 (VGA) in YUV output mode and the available minimum size is 128 x 96 (subQCIF).

9.2. Image sizer

The image sizer function enables the monitoring (sub sampling) mode on given image with scale factors of 1, 1/2, and 1/4. The available minimum image output is 128 x 96 (subQCIF). Monitoring (sub sampling) mode has a limited output format.

This function can be used like a zoom function. Digital x2 zoom is available under QVGA or less monitoring operation and digital x2 and x4 zoom is available under QQVGA or less monitoring operation.

9.3. Picture flip

Horizontal and vertical flip modes are controlled by I²C commands. Each flip mode is selectable separately as below.

No.	Mode
0	Original
1	Horizontal flip
2	Vertical flip
3	Vertical and Horizontal flip (180 deg rotation)

Table 7 Flip mode

9.4. Picture effects

The picture effect function supports some kind of pictures with special effects as below. It is controlled by I²C bus commands.

Normal / Monochrome / Negative / Sepia / Emboss / Sketch

9.5. Dynamic range adjustment

Dynamic range adjustment function supports programmable black level adjustment, high luminance level signal compression and others.

9.6. Gamma correction

Gamma correction function supports fixed gamma tables only. Fixed gamma table coefficients are 0.45, 0.55, and 0.65.

9.7. Auto luminance control

Auto luminance control (ALC) function is also called Auto Exposure (AE) control. It enables the system to adjust the electrical shutter speed, digital gain and analog gain to adapt to the ambient light automatically to achieve proper brightness of the image. The luminance convergence level, sampling location, EV shift and others can be controlled via I²C bus. It also has manual mode.

9.8. Analog gain control

Analog gain control is used to adjust the gain of the amplifier of pixel cell. It is often used in dark environment to increase brightness of the image automatically. It also has manual mode.

9.9. White balance

Two modes are available for white balance control under different lighting conditions; manual white balance control and auto white balance control. In manual white balance control mode, it can specify the gain for each color to achieve special effects. In auto white balance control mode, the system supports the gain setting for the white balance based on limit conditions (such as sampling area and range of gain) specified by the user via I²C bus.

9.10. Auto flicker detection and correction

Auto flicker detection and correction function can correct a fluorescent flicker for both AC 50Hz and 60Hz automatically. However, it is impossible to detect a flicker when shutter speed is faster than 1/100s (Very brighter condition).

9.11. Statistical data output

ALC statistical data are calculated in ISP every frame continuously. The region for calculating is selectable from all area, center only and center weighted mode. The statistical data can be read via I²C bus in read mode. AWB statistical data is also calculated in ISP every frame continuously.

9.12. Color separation

Color separation function separates color from sensor bayer arrangement.

9.13. Color matrix

Color matrix can adjust each color via I²C bus. It can control 6 factors.

9.14. Edge enhancement

Edge enhancement can emphasize edges in an image. It can be set V edge and H edge independently. It also can adjust an enhancement level via I²C bus.

9.15. Brightness and contrast

Brightness and Contrast can be adjusted via I²C bus.

9.16. Lens shading correction

The lens shading function can change the pixel gain of off center area to compensate the loss caused by lens shading effect. The correction gain and starting location are programmable across the shading area via I²C bus. It can be set V and H separately.

9.17. Blemish correction

Blemish correction supports to correct fixed white and black pixels automatically.

9.18. Test charts

For connection test, it has built-in color bar charts, color/grayscale ramp charts and others.

9.19. Test pattern output

For connection test of input/output terminals, it is available to output 1/0 value via I²C bus.

10. Timing Chart

10.1. Power management modes

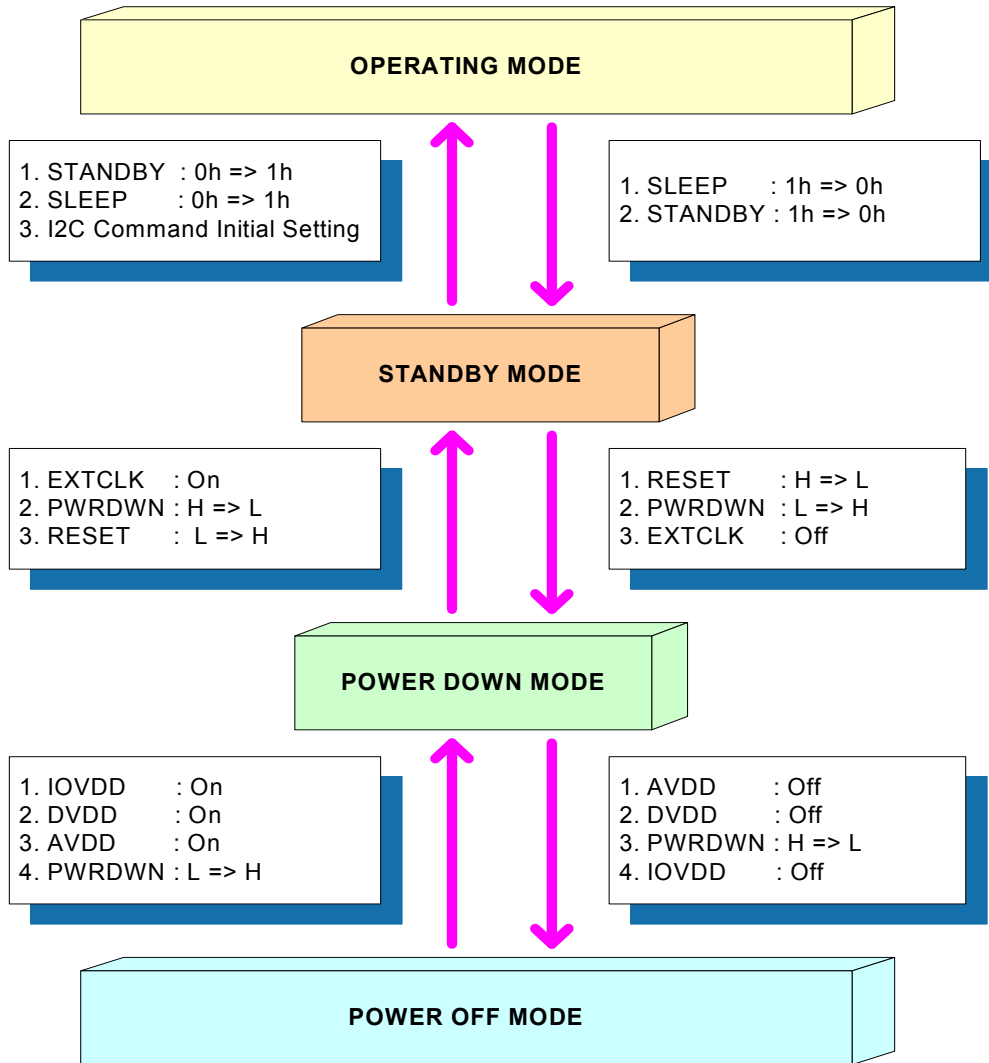

Figure 5 Power management states

Mode	Comment
OPERATING MDOE	All circuits are active.
STANDBY MODE	Internal digital circuits and clock control circuits are Disable for low power consumption while STANDBY and SLEEP registers are set to "0".
POWER DOWN MODE	All power are set. Clock is not provided.
POWER OFF MDOE	All power supplies are turned off .

Table 8 Power management mode

10.2. Power on/off sequence

10.2.1. Power on sequence (w/ built-in regulator)

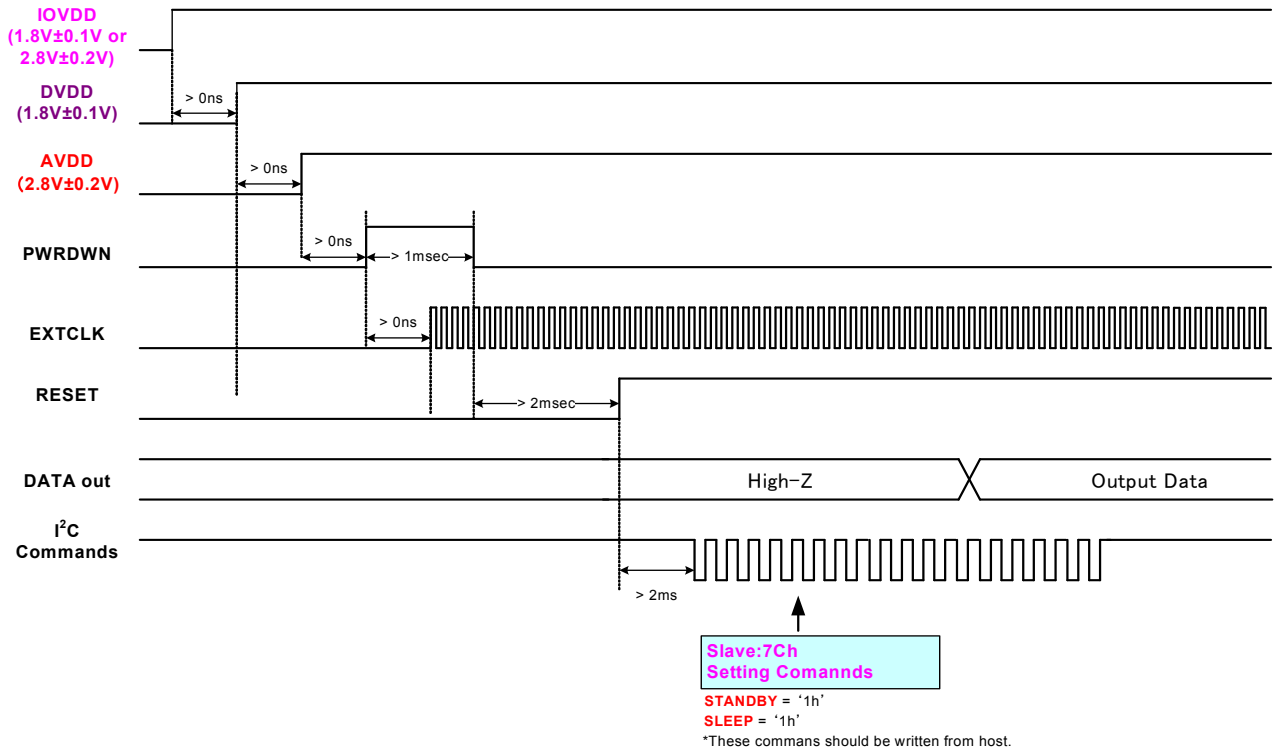

Figure 6.1 Power on sequence (w/ built-in regulator)

10.2.2. Power off sequence (w/ built-in regulator)

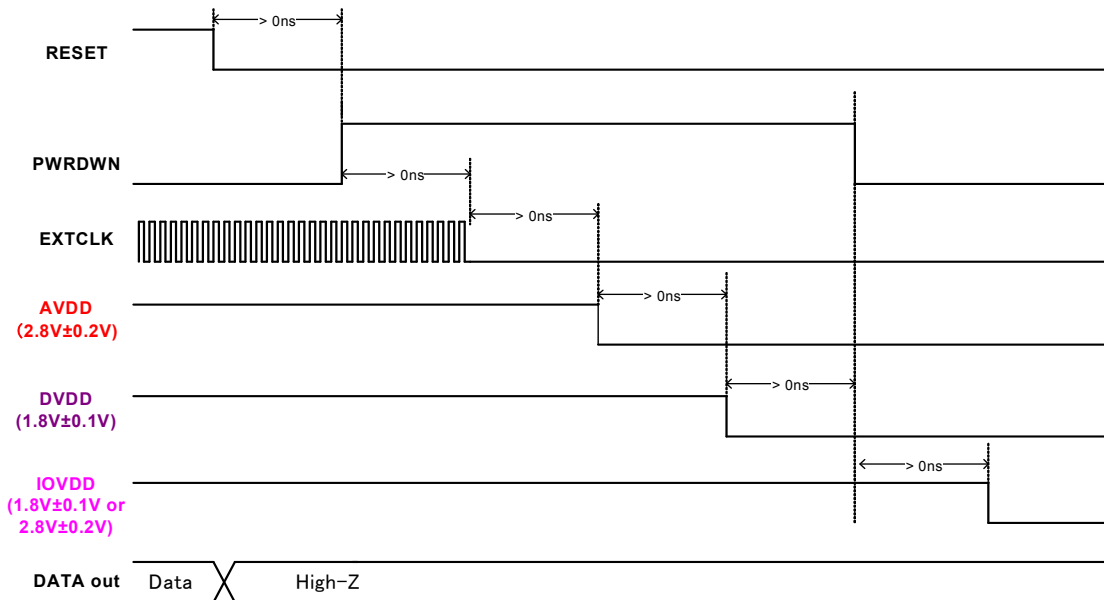

Figure 6.2 Power off sequence (w/ built-in regulator)

10.3. Output signal waveform

It can be output DCLK during blanking pulse low. It means DCLK is output continuously.

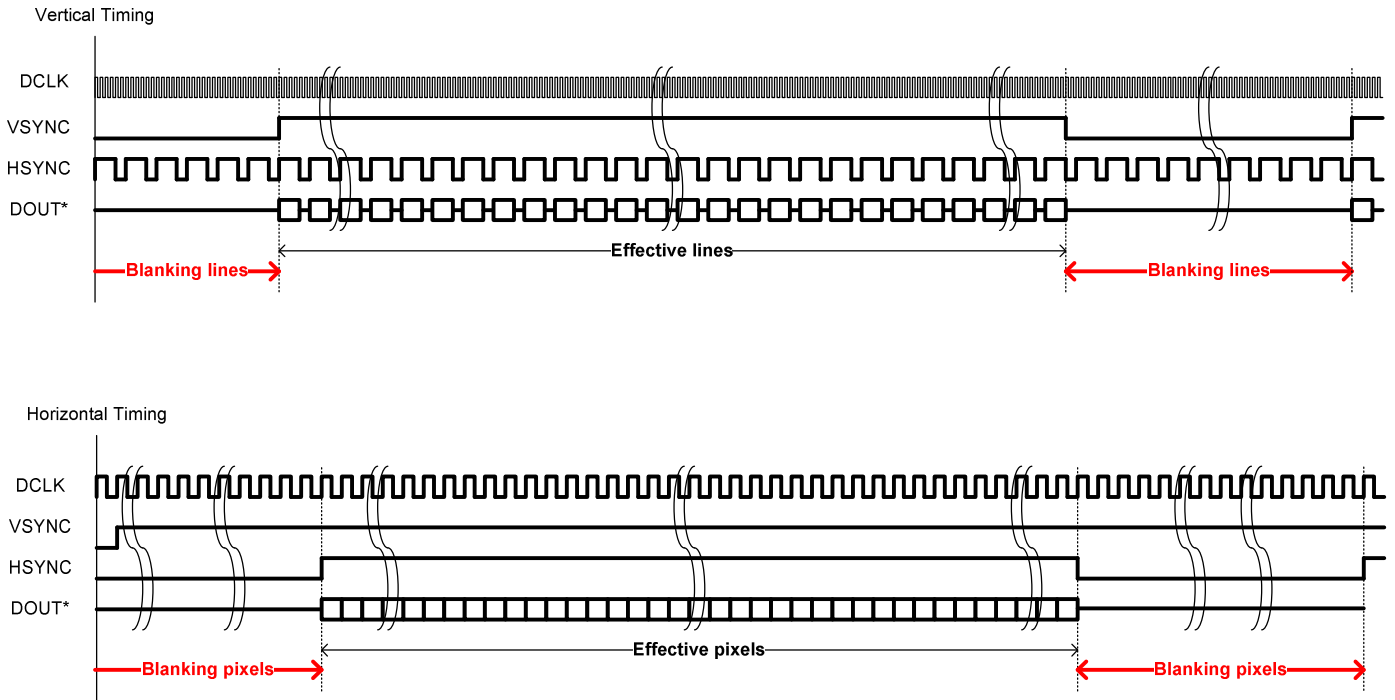

Figure 7 Example of output waveform (VGA output)

11. Register descriptions

Slave address = 7Ch/7Dh

Sub Add. (Hex)	bit	Register name	Description	Read only or R/W	Default (Hex)
00	D7-0	VER_NUM [7:0]	Chip version identification	R	48
01	D7-0	VER_NUM[15:8]		R	10
02	D7-0	ALCDATA[7:0]	Shows internal ALC accumulated data. (Lower bits)	R	00
03	D7	ALC_AC5060	Shows internal detection result on Flicker detection. 0h: 50Hz detected 1h: 60Hz detected	R	00
	D6-4	ALC_LES_MODE[2:0]	Shows current LES mode.		
	D3-2	Reserved	Reserved		
	D1-0	ALCDATA[9:8]	Shows internal ALC accumulated data. (Upper bits)		
04	D7-0	ALC_AGOUT[7:0]	Shows the analog gain status of ALC. (Lower bits)	R	00
05	D7-4	Reserved	Reserved	R	00
	D3-0	ALC_AGOUT[11:8]	Shows the analog gain status of ALC. (Upper bits)		
06	D7-0	ALC_DGOUT[7:0]	Shows the digital gain status of ALC.	R	00
07	D7-0	ALC_ESOUT[7:0]	Shows the accumulated number of electrical shutter lines. (Lower bits)	R	00
08	D7-6	Reserved	Reserved	R	00
	D5-0	ALC_ESOUT[13:8]	Shows the accumulated number of electrical shutter lines. (Upper bits)		
09	D7-0	AWB_UOUT[7:0]	Shows the accumulated value of U signal referred as AWB. (Lower bits)	R	00
0A	D7-0	AWB_UOUT[15:8]		R	00
0B	D7-0	AWB_UOUT[23:16]		R	00
0C	D7-6	Reserved	Reserved	R	00
	D5-0	AWB_UOUT[29:24]	Shows the accumulated value of U signal referred as AWB. (Upper bits)		
0D	D7-0	AWB_VOUT[7:0]	Shows the accumulated value of V signal referred as AWB. (Lower bits)	R	00
0E	D7-0	AWB_VOUT[15:8]		R	00
0F	D7-0	AWB_VOUT[23:16]		R	00
10	D7-6	Reserved	Reserved	R	00
	D5-0	AWB_VOUT[29:24]	Shows the accumulated value of V signal referred as AWB. (Upper bits)		
11	D7-0	AWB_PIXOUT[7:0]	Shows the number of pixels referred as AWB. (Lower bits)	R	00
12	D7-0	AWB_PIXOUT[15:8]		R	00
13	D7-3	Reserved	Reserved	R	00
	D2-0	AWB_PIXOUT[18:16]	Shows the number of pixels referred as AWB. (Upper bits)		
14	D7-0	AWB_RGOUT[7:0]	Shows the R gain for white balance.	R	00
15	D7-0	AWB_GGOUT[7:0]	Shows the G gain for white balance.	R	00
16	D7-0	AWB_BGOUT[7:0]	Shows the B gain for white balance.	R	00
17	D7-0	Reserved	Reserved	R	00
18	D7	STANDBY	Software standby mode SW 0h: Standby 1h: Normal	R/W	9C
	D6-0	Reserved	Reserved		
19	D7-0	Reserved	Reserved	R/W	04
1A	D7	VCO_STP_X	VCOPLL core SW 0h: Stop 1h: Active	R/W	90
	D6-0	Reserved	Reserved		
1B	D7-4	Reserved	Reserved	R/W	00
	D3-0	CKREF_DIV[3:0]	PLL divider control for reference clock (EXTCLK) 0h: 1/5 Fh: 1/20		
1C	D7-0	Reserved	Reserved	R/W	00

Sub Add. (Hex)	bit	Register name	Description	Read only or R/W	Default (Hex)
35	D7-0	Reserved	Reserved	R/W	00
36	D7-0	Reserved	Reserved	R/W	0C
37	D7-0	Reserved	Reserved	R/W	22
38	D7-0	Reserved	Reserved	R/W	0B
39	D7-0	Reserved	Reserved	R/W	AA
3A	D7-0	Reserved	Reserved	R/W	0A
3B	D7-0	Reserved	Reserved	R/W	84
3C	D7-0	Reserved	Reserved	R/W	03
3D	D7-0	Reserved	Reserved	R/W	10
3E	D7-0	Reserved	Reserved	R/W	4C
3F	D7-0	Reserved	Reserved	R/W	1D
40	D7-0	Reserved	Reserved	R/W	14
41	D7-0	Reserved	Reserved	R/W	05
42	D7-0	Reserved	Reserved	R/W	12
43	D7-0	Reserved	Reserved	R/W	B0
44	D7-0	Reserved	Reserved	R/W	3F
45	D7-0	Reserved	Reserved	R/W	7F
46	D7-0	Reserved	Reserved	R/W	44
47	D7-0	Reserved	Reserved	R/W	44
48	D7-0	Reserved	Reserved	R/W	00
49	D7-0	Reserved	Reserved	R/W	E8
4A	D7-0	Reserved	Reserved	R/W	00
4B	D7-0	Reserved	Reserved	R/W	9F
4C	D7-0	Reserved	Reserved	R/W	C0
4D	D7-0	Reserved	Reserved	R/W	24
4E	D7-0	Reserved	Reserved	R/W	52
4F	D7-0	Reserved	Reserved	R/W	71
50	D7-0	Reserved	Reserved	R/W	0E
51	D7-0	Reserved	Reserved	R/W	00
52	D7-0	Reserved	Reserved	R/W	00
53	D7-3	TP_MODE[4:0]	Test pattern selection 00h : Normal 01h-06h : Normal picture + Cross line 07h : Reserved 08h : Frame 09h-10h : Color-bar 11h-17h : Gray scale (with color) 18h : Color-bar (Horizontal ramp) 19h-1Fh : Horizontal and vertical ramp	R/W	0E
	D2-1	Reserved	Reserved		
	D0	TPG_LINE_SW	Test pattern of Center cross line 0h: OFF 1h: ON		
54	D7-0	Reserved	Reserved	R/W	08
55	D7-0	Reserved	Reserved	R/W	14
56	D7-0	Reserved	Reserved	R/W	84
57	D7-0	Reserved	Reserved	R/W	30
58	D7-0	Reserved	Reserved	R/W	80
59	D7-0	Reserved	Reserved	R/W	80
5A	D7-0	Reserved	Reserved	R/W	00
5B	D7-0	Reserved	Reserved	R/W	06
5C	D7-4	LINE_RLV[3:0]	Red level setting for Center cross test pattern 0h: Min. Ch-Fh: Max.	R/W	50
	D3-0	Reserved	Reserved		

Sub Add. (Hex)	bit	Register name	Description	Read only or R/W	Default (Hex)
5D	D7-4	LINE_GLV[3:0]	Green level setting for Center cross test pattern 0h: Min. Ch-Fh: Max.	R/W	A5
	D3-0	Reserved	Reserved		
5E	D7-4	LINE_BLV[3:0]	Blue level setting for Center cross test pattern 0h: Min. Ch-Fh: Max.	R/W	5A
	D3-0	Reserved	Reserved		
5F	D7-0	Reserved	Reserved	R/W	B0
60	D7-0	Reserved	Reserved	R/W	00
61	D7-0	Reserved	Reserved	R/W	1B
62	D7-0	Reserved	Reserved	R/W	4E
63	D7-0	Reserved	Reserved	R/W	04
64	D7	LDNR_SW	Random noise reduction SW 0h: OFF 1h: ON	R/W	90
	D6-0	Reserved	Reserved		
65	D7-0	AGMIN_LDNR_WIDTH[7:0]	Slice level setting for Noise reduction while Analog gain condition is min. (=under high light) 00h: Min. FFh: Max.	R/W	30
66	D7-0	AGMAX_LDNR_WIDTH[7:0]	Slice level setting for Noise reduction while Analog gain condition is max. (=under low light) 00h: Min. FFh: Max.	R/W	30
67	D7-0	AGMIN_LDNR_MP[7:0]	Gain setting for Noise reduction while Analog gain condition is min. (=under high light) 00h: Min. FFh: Max.	R/W	66
68	D7-0	AGMAX_LDNR_MP[7:0]	Gain setting for Noise reduction while Analog gain condition is max. (=under low light) 00h: Min. FFh: Max.	R/W	66
69	D7-0	Reserved	Reserved	R/W	C0
6A	D7-0	Reserved	Reserved	R/W	30
6B	D7-0	Reserved	Reserved	R/W	30
6C	D7-0	Reserved	Reserved	R/W	10
6D	D7-0	Reserved	Reserved	R/W	30
6E	D7-0	Reserved	Reserved	R/W	AB
6F	D7-0	Reserved	Reserved	R/W	30
70	D7-0	AGMIN_BLACK_ADJ[7:0]	Fine setting for Black level while Analog gain condition is min. 00h: Min. FFh: Max.	R/W	80
71	D7-0	AGMAX_BLACK_ADJ[7:0]	Fine setting for Black level while Analog gain condition is max. 00h: Min. FFh: Max.	R/W	80
72	D7-0	IDR_SET[7:0]	Saturation level setting 00h: 100% 55h: 130% FFh: 200%	R/W	55
73	D7-0	PWB_RG[7:0]	Preset WB setting for R pixels 00h: x1 80h: x2 FFh: x3	R/W	00
74	D7-0	PWB_GRG[7:0]	Preset WB setting for Gr pixels 00h: x1 80h: x2 FFh: x3	R/W	04
75	D7-0	PWB_GBG[7:0]	Preset WB setting for Gb pixels 00h: x1 80h: x2 FFh: x3	R/W	04
76	D7-0	PWB_BG[7:0]	Preset WB setting for B pixels 00h: x1 80h: x2 FFh: x3	R/W	62
77	D7-0	Reserved	Reserved	R/W	00
78	D7	LSSC_SW	Lens shading correction SW 0h: OFF 1h: ON	R/W	80
	D6-0	Reserved	Reserved		
79	D7-0	Reserved	Reserved	R/W	52
7A	D7-0	Reserved	Reserved	R/W	4F

Sub Add. (Hex)	bit	Register name	Description	Read only or R/W	Default (Hex)
7B	D7-0	LSSC_LEFT_RG[7:0]	R gain on the left side for Lens shading correction 00h: Min. FFh: Max.	R/W	00
7C	D7-0	LSSC_LEFT_GG[7:0]	G gain on the left side for Lens shading correction 00h: Min. FFh: Max.	R/W	00
7D	D7-0	LSSC_LEFT_BG[7:0]	B gain on the left side for Lens shading correction 00h: Min. FFh: Max.	R/W	00
7E	D7-0	LSSC_RIGHT_RG[7:0]	R gain on the right side for Lens shading correction 00h: Min. FFh: Max.	R/W	00
7F	D7-0	LSSC_RIGHT_GG[7:0]	G gain on the right side for Lens shading correction 00h: Min. FFh: Max.	R/W	00
80	D7-0	LSSC_RIGHT_BG[7:0]	B gain on the right side for Lens shading correction 00h: Min. FFh: Max.	R/W	00
81	D7-0	LSSC_TOP_RG[7:0]	R gain on the top side for Lens shading correction 00h: Min. FFh: Max.	R/W	00
82	D7-0	LSSC_TOP_GG[7:0]	G gain on the top side for Lens shading correction 00h: Min. FFh: Max.	R/W	00
83	D7-0	LSSC_TOP_BG[7:0]	B gain on the top side for Lens shading correction 00h: Min. FFh: Max.	R/W	00
84	D7-0	LSSC_BOTTOM_RG[7:0]	R gain on the bottom side for Lens shading correction 00h: Min. FFh: Max.	R/W	00
85	D7-0	LSSC_BOTTOM_GG[7:0]	G gain on the bottom side for Lens shading correction 00h: Min. FFh: Max.	R/W	00
86	D7-0	LSSC_BOTTOM_BG[7:0]	B gain on the bottom side for Lens shading correction 00h: Min. FFh: Max.	R/W	00
87	D7-2	Reserved	Reserved	R/W	01
	D1-0	LSSC_MP_MODE[1:0]	Gain setting for Lens shading correction 0h: x1/8 1h: x1/4 2h: x1/2 3h: x1		
88	D7-0	Reserved	Reserved	R/W	00
89	D7-0	Reserved	Reserved	R/W	00
8A	D7-0	PP_BLACK_ADJ[7:0]	Black level setting after Lens shading correction 00h: Min. FFh: Max.	R/W	40
8B	D7-0	Reserved	Reserved	R/W	09
8C	D7-0	Reserved	Reserved	R/W	E0
8D	D7-0	Reserved	Reserved	R/W	C0
8E	D7-0	Reserved	Reserved	R/W	80
8F	D7-0	Reserved	Reserved	R/W	C0
90	D7-0	Reserved	Reserved	R/W	80
91	D7	ANR_SW	Noise reduction SW 0h: OFF 1h: ON	R/W	80
	D6-0	Reserved	Reserved		
92	D7-0	AGMIN_ANR_WIDTH[7:0]	Slice level setting for Noise reduction while Analog gain condition is min. 00h: Min. FFh: Max.	R/W	80
93	D7-0	AGMAX_ANR_WIDTH[7:0]	Slice level setting for Noise reduction while Analog gain condition is max. 00h: Min. FFh: Max.	R/W	80
94	D7-0	AGMIN_ANR_MP[7:0]	Gain setting for Noise reduction while Analog gain condition is min. 00h: Min. FFh: Max.	R/W	40
95	D7-0	AGMAX_ANR_MP[7:0]	Gain setting for Noise reduction while Analog gain condition is max. 00h: Min. FFh: Max.	R/W	40
96	D7	DTL_SW	Edge enhancement SW 0h: OFF 1h: ON	R/W	80
	D6-0	Reserved	Reserved		

Sub Add. (Hex)	bit	Register name	Description	Read only or R/W	Default (Hex)
97	D7-0	AGMIN_HDTL_NC[7:0]	Coring level setting for Horizontal edge enhancement while Analog gain condition is min. 00h: Min. FFh: Max.	R/W	07
98	D7-0	AGMIN_VDTL_NC[7:0]	Coring level setting for Vertical edge enhancement while Analog gain condition is min. 00h: Min. FFh: Max.	R/W	03
99	D7-0	AGMAX_HDTL_NC[7:0]	Coring level setting for Horizontal edge enhancement while Analog gain condition is max. 00h: Min. FFh: Max.	R/W	07
9A	D7-0	AGMAX_VDTL_NC[7:0]	Coring level setting for Vertical edge enhancement while Analog gain condition is max. 00h: Min. FFh: Max.	R/W	03
9B	D7-0	AGMIN_HDTL_MG[7:0]	Edge enhancement gain setting to Horizontal edges toward black while Analog gain condition is min. 00h: Min. FFh: Max.	R/W	80
9C	D7-0	AGMIN_HDTL_PG[7:0]	Edge enhancement gain setting for Horizontal edges toward white while Analog gain condition is min. 00h: Min. FFh: Max.	R/W	20
9D	D7-0	AGMIN_VDTL_MG[7:0]	Edge enhancement gain setting for Vertical edges toward black while Analog gain condition is min. 00h: Min. FFh: Max.	R/W	40
9E	D7-0	AGMIN_VDTL_PG[7:0]	Edge enhancement gain setting for Vertical edges toward white while Analog gain condition is min. 00h: Min. FFh: Max.	R/W	10
9F	D7-0	AGMAX_HDTL_MG[7:0]	Edge enhancement gain setting for Horizontal edges toward black while Analog gain condition is max. 00h: Min. FFh: Max.	R/W	80
A0	D7-0	AGMAX_HDTL_PG[7:0]	Edge enhancement gain setting for Horizontal edges toward white while Analog gain condition is max. 00h: Min. FFh: Max.	R/W	20
A1	D7-0	AGMAX_VDTL_MG[7:0]	Edge enhancement gain setting for Vertical edges toward black while Analog gain condition is max. 00h: Min. FFh: Max.	R/W	40
A2	D7-0	AGMAX_VDTL_PG[7:0]	Edge enhancement gain setting for Vertical edges toward white while Analog gain condition is max. 00h: Min. FFh: Max.	R/W	10
A3	D7-0	PE_HVDTL_G[7:0]	Edge enhancement gain setting for Picture effect mode. It's valid while PIC_EFFECT = 5h, 6h or 7h. 00h: Min. FFh: Max.	R/W	80
A4	D7	HCBC_SW	Horizontal carrier boost correction SW 0h: OFF 1h: ON	R/W	82
	D6-0	Reserved	Reserved		
A5	D7-0	AGMIN_HCBC_G[7:0]	Gain setting for Horizontal carrier boost correction while Analog gain condition is min. 00h: Min. FFh: Max.	R/W	55
A6	D7-0	AGMAX_HCBC_G[7:0]	Gain setting for Horizontal carrier boost correction while Analog gain condition is max. 00h: Min. FFh: Max.	R/W	55
A7	D7-0	Reserved	Reserved	R/W	80
A8	D7-0	Reserved	Reserved	R/W	80
A9	D7-0	Reserved	Reserved	R/W	80

Sub Add. (Hex)	bit	Register name	Description	Read only or R/W	Default (Hex)
B6	D7-0	BRIGHT[7:0]	Brightness setting for Y signal 00h: -128 80h: -/+0 FFh: +127	R/W	80
B7	D7-0	Reserved	Reserved	R/W	00
B8	D7-0	Reserved	Reserved	R/W	FF
B9	D7-0	U_GAIN[7:0]	Gain setting for U signal $U = (B - Y) / 128 \times U_GAIN[7:0]$	R/W	48
BA	D7-0	V_GAIN[7:0]	Gain setting for U signal $V = (R - Y) / 128 \times V_GAIN[7:0]$	R/W	5B
BB	D7-0	SEPIA_US[7:0]	DC offset level setting for U signal for Sepia effect picture 00h: -128 80h: -/+0 FFh: +127	R/W	78
BC	D7-0	SEPIA_VS[7:0]	DC offset level setting for V signal for Sepia effect picture 00h: -128 80h: -/+0 FFh: +127	R/W	90
BD	D7-0	U_CORING[7:0]	Coring level setting for U signal (small signal will be compressed) 00h: Min. FFh: Max.	R/W	03
BE	D7-0	V_CORING[7:0]	Coring level setting for V signal (small signal will be compressed) 00h: Min. FFh: Max.	R/W	03
BF	D7	YDTL_SW	Edge enhancement SW for high frequency components of Y signal 0h: OFF 1h: ON	R/W	C0
	D6	UVLPF_SW	LPF SW for UV signals 0h: OFF 1h: ON		
	D5-0	Reserved	Reserved		
C0	D7-0	YDTL_G[7:0]	Edge enhancement gain setting for high frequency components of Y signal 00h: Min. FFh: Max.	R/W	00
C1	D7-0	Reserved	Reserved	R/W	00
C2	D7	ALC_SW	ALC SW 0h: OFF 1h: ON	R/W	80
	D6	ALC_LOCK	Holds the exposure condition of ALC 0h: OFF 1h: ON (Lock)		
	D5-0	Reserved	Reserved		
C3	D7-0	MES[7:0]	Manual exposure adjusting (Lower bits). It's valid while ALC_SW = OFF. 0000h: Min. 3FFFh: Max.	R/W	2C
C4	D7-6	Reserved	Reserved	R/W	01
	D5-0	MES[13:8]	Manual exposure adjusting (Upper bits). See Sub-address C3h.		
C5	D7-0	MDG[7:0]	Manual Digital gain setting 00h: Min. FFh: Max.	R/W	00
C6	D7-0	MAG[7:0]	Manual Analog gain setting (Lower bits). It's valid while ALC_SW = OFF. 000h: Min. FFFh: Max	R/W	20
C7	D7-6	AGCONT_SEL[1:0]	Gain range setting for the changing gains according to AG condition. This setting affects AGMAX/MIN***G registers. 0h: Min. 3h: Max.	R/W	80
	D5-4	Reserved	Reserved		
	D3-0	MAG[11:8]	Manual Analog gain setting (Upper bits). See Sub-address C6h.		
C8	D7-0	AG_MIN[7:0]	Min. limiter setting for Analog gain for ALC 00h: Min. FFh: Max.	R/W	20
C9	D7-0	AG_MAX[7:0]	Max. limiter setting for Analog gain for ALC 00h: Min. FFh: Max.	R/W	0F

Sub Add. (Hex)	bit	Register name	Description	Read only or R/W	Default (Hex)
DC	D7-0	Reserved	Reserved	R/W	14
DD	D7-0	Reserved	Reserved	R/W	00
DE	D7	AWB_SW	Auto white balance SW 0h: OFF 1h: ON	R/W	80
	D6	AWB_LOCK	Holds Auto white balance condition 0h: OFF (AWB active) 1h: ON (AWB freeze)		
	D5-0	Reserved	Reserved		
DF	D7-0	WB_MRG[7:0]	R gain setting for manual WB 00h: Min. FFh: Max.	R/W	80
E0	D7-0	WB_MGG[7:0]	G gain setting for manual WB 00h: Min. FFh: Max.	R/W	80
E1	D7-0	WB_MBG[7:0]	B gain setting for manual WB 00h: Min. FFh: Max.	R/W	80
E2	D7-0	WB_RBMIN[7:0]	Lower limit gain setting for RB gain on AWB 00h: Min. FFh: Max.	R/W	40
E3	D7-0	WB_RBMAX[7:0]	Upper limit gain setting for RB gain on AWB 00h: Min. FFh: Max.	R/W	FF
E4	D7	HEXA_SW	Hexagonal color detection gate SW 0h: OFF 1h: ON (Hexagonal gate active)	R/W	90
	D6	Reserved	Reserved		
	D5-4	COLGATE_RANGE[1:0]	Range SW for Hexagonal color detection gate setting 0h: 1 pixel/step (total range: -127 to 127 pixels) 1h: 2 pixel/step (total range: -254 to 254 pixels) 2h: 4 pixel/step (total range: -508 to 508 pixels) 3h: 8 pixel/step (total range: -1016 to 1016 pixels)		
	D3-1	Reserved	Reserved		
	D0	COLGATE_OPEN	Opens the color detection gate 0h: OFF (Color gate active) 1h: ON (Opens gate, Color gate setting invalid)		
E5	D7	Reserved	Reserved	R/W	20
	D6-0	RYCUTM[6:0]	Lower limit level setting for R-Y of Hexagonal color detection gate 00h: Narrowest FFh: Widest		
E6	D7	Reserved	Reserved	R/W	50
	D6-0	RYCUTP[6:0]	Upper limit level setting for R-Y of Hexagonal color detection gate 00h: Narrowest FFh: Widest		
E7	D7	Reserved	Reserved	R/W	38
	D6-0	BYCUTM[6:0]	Lower limit level setting for B-Y of Hexagonal color detection gate 00h: Narrowest FFh: Widest		
E8	D7	Reserved	Reserved	R/W	20
	D6-0	BYCUTP[6:0]	Upper limit level setting for B-Y of Hexagonal color detection gate 00h: Narrowest FFh: Widest		
E9	D7-0	RBCUTL[7:0]	Lower cross point on R-Y axis setting for Hexagonal color detection gate 80h: Widest 00h: Center 7Fh: Narrowest	R/W	F0
EA	D7-0	RBCUTH[7:0]	Upper cross point on R-Y axis setting for Hexagonal color detection gate 80h: Narrowest 00h: Center 7Fh: Widest	R/W	18

Sub Add. (Hex)	bit	Register name	Description	Read only or R/W	Default (Hex)
FB	D7	Reserved	Reserved	R/W	50
	D6-0	H_WIDTH[6:0]	Horizontal picture size setting [H width] = H_WIDTH[6:0] x 8		
FC	D7-0	V_START[7:0]	Vertical picture start position setting [V start point] = V_START[7:0] x 2 + 1	R/W	0C
FD	D7-6	Reserved	Reserved	R/W	3C
	D5-0	V_HEIGHT[5:0]	Vertical picture size setting [V height] = V_HEIGHT[5:0] x 8		
FE	D7-4	PIC_FORMAT[3:0]	Picture output format setting 0h: Raw-6 (Time shared 10bit) 1h: YUV422 (6bit) 4h: Raw-8 (Time shared 10bit) 5h: YUV422 (8bit) 8h: Raw-8 (8bit) 2h, 3h, 6h, 7h, 9h-Fh: Reserved	R/W	50
	D3-0	Reserved	Reserved		
FF	D7	SLEEP	Software standby setting. Set this register with STANDBY. 0h: ON (Standby) 1h: OFF (Normal)	R/W	35
	D6	Reserved	Reserved		
	D5-4	PARALLEL_OUTSW[1:0]	Data output test mode SW 0h: Normal 1h: All L 2h: All H 3h: All High-Z		
	D3	DCLK_POL	DCLK output polarity SW 0h: Normal 1h: Inverted		
	D2-0	Reserved	Reserved		

12. Electrical Characteristics

12.1. Absolute Maximum Ratings

Items	Symbol	Rating	Unit
Power supply voltage	AVDD DVDD IOVDD	-0.3 to 3.6	V
	DVDD15 AVDD15	-0.3 to 3.0	
Input voltage	V_{in}	-0.3 to IOVDD+0.3	
Input current of protection diode	I_{in}	+/- 20	mA
Storage temperature	T_{stg}	-30 to 85	°C

The absolute maximum ratings of a semiconductor device are a set of specified parameter values, which must not be exceeded during operation, even for an instant.

If any of these rating would be exceeded during operation, the device electrical characteristics may be irreparably altered and the reliability and lifetime of the device can no longer be guaranteed.

Moreover, these operations with exceeded ratings may cause break down, damage and/or degradation to any other equipment. Applications using the device should be designed such that each maximum rating will never be exceeded in any operating conditions.

Before using, creating and/or producing designs, refer to and comply with the precautions and conditions set forth in this documents.

12.2. Operating Conditions

Item	Symbol	Rating			Unit
		Min.	Typ.	Max.	
Power supply voltage	AVDD	2.6	2.8	3.0	V
	DVDD	1.7	1.8	1.9	
	IOVDD *3	1.7	1.8	1.9	
		2.6	2.8	3.0	
DVDD15 *4 AVDD15 *4	1.4	1.5	1.6		
Input voltage	V_{in}	0	-	IOVDD	
Operating temperature *1	T_{opr}	-20 to 60			°C
Functional temperature *2	T_{func}	-30 to 70			

Notes:

*1: Operating temperature is the temperature range that performance is guaranteed.

*2: Functional temperature is the temperature range that function is guaranteed, however performance is not guaranteed.

*3: The power supply for IOVDD is 1.8V +/- 0.1V or 2.8V +/- 0.2V.

*4 In case the build-in regulator is not used.

12.3. DC Characteristics

Condition: Ta=25 degree C

AVDD=2.8V, DVDD =1.8V, IOVDD=1.8V

Items	Symbol	Conditions	Rating			Unit	
			Min.	Typ.	Max.		
Current consumption	DVDD	$I_{DVDD \text{ NORMAL}}$	Normal, 30fps, VGA	-	-	30	mA
	IOVDD	$I_{IOVDD \text{ NORMAL}}$		-	-	5.1	mA
	AVDD	$I_{AVDD \text{ NORMAL}}$		-	-	8	mA
	DVDD	$I_{DVDD \text{ SW STBY}}$	Standby mode (Software standby)	-	-	500	μ A
	IOVDD	$I_{IOVDD \text{ SW STBY}}$		-	-	50	μ A
	AVDD	$I_{AVDD \text{ SW STBY}}$		-	-	50	μ A
	DVDD	$I_{DVDD \text{ HW STBY}}$	Power down mode (Hardware standby)	-	-	10	μ A
	IOVDD	$I_{IOVDD \text{ HW STBY}}$		-	-	10	μ A
AVDD	$I_{AVDD \text{ HW STBY}}$	-		-	10	μ A	
EXTCLK input voltage (sine wave)*	Peak to peak voltage	$V_{pp \text{ CLK}}$	-	0.5	-	1.2	V
EXTCLK input (square wave)	Low level input voltage	$V_{IL \text{ CLK}}$	-	-	-	IOVDDx0.2	V
	High level input voltage	$V_{IH \text{ CLK}}$	-	IOVDDx0.8	-	-	V
DATA output	Low level output voltage	$V_{OL \text{ DOUT}}$	-	-	-	IOVDDx0.2	V
	High level output voltage	$V_{OH \text{ DOUT}}$	-	IOVDDx0.8	-	-	V
HSYNC, VSYNC output	Low level output voltage	$V_{OL \text{ SYNC}}$	-	-	-	IOVDDx0.2	V
	High level output voltage	$V_{OH \text{ SYNC}}$	-	IOVDDx0.8	-	-	V
DCLK output	Low level output voltage	$V_{OL \text{ DCLK}}$	-	-	-	IOVDDx0.2	V
	High level output voltage	$V_{OH \text{ DCLK}}$	-	IOVDDx0.8	-	-	V
RESET input	Low level input voltage	$V_{IL \text{ RESET}}$	-	-	-	IOVDDx0.2	V
	High level input voltage	$V_{IH \text{ RESET}}$	-	IOVDDx0.8	-	-	V
PWRDWN input	Low level input voltage	$V_{IL \text{ PWRDWN}}$	-	-	-	IOVDDx0.2	V
	High level input voltage	$V_{IH \text{ PWRDWN}}$	-	IOVDDx0.8	-	-	V
SCL input	Low level input voltage	$V_{IL \text{ SCL}}$	-	-	-	IOVDDx0.2	V
	High level input voltage	$V_{IH \text{ SCL}}$	-	IOVDDx0.8	-	-	V
SDA input/output	Low level input voltage	$V_{IL \text{ SDA}}$	-	-	-	IOVDDx0.2	V
	High level input voltage	$V_{IH \text{ SDA}}$	-	IOVDDx0.8	-	-	V
	Low level output voltage	$V_{OL \text{ SDA}}$	-	-	-	0.4	V

*Note:

In case of a sine wave using for EXTCLK, a coupling capacitor is required with the input terminal.

12.4. AC Characteristics

12.4.1. EXTCLK input conditions

Items	Symbol	Condition	Min.	Typ.	Max.	Unit
EXTCLK frequency	f_{EXTCLK}	With built-in PLL	9.0	-	26.0	MHz
Fall time	$t_{f,CLK}$	-	-	-	5	ns
Clock duty	$DUTY_{EXTCLK}$	-	45/55	-	55/45	%

Table 9 EXTCLK input conditions

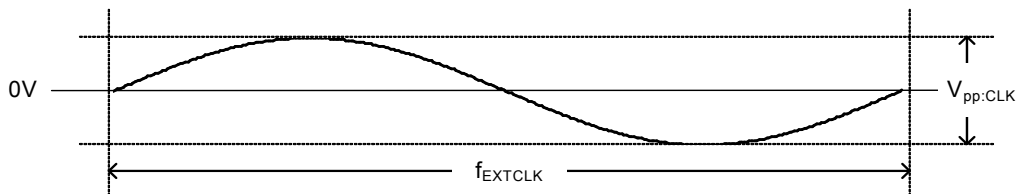

Note:
In case of a sine wave using for EXTCLK, a coupling capacitor is required with the input terminal.

Figure 8 EXTCLK waveform (Sine wave)

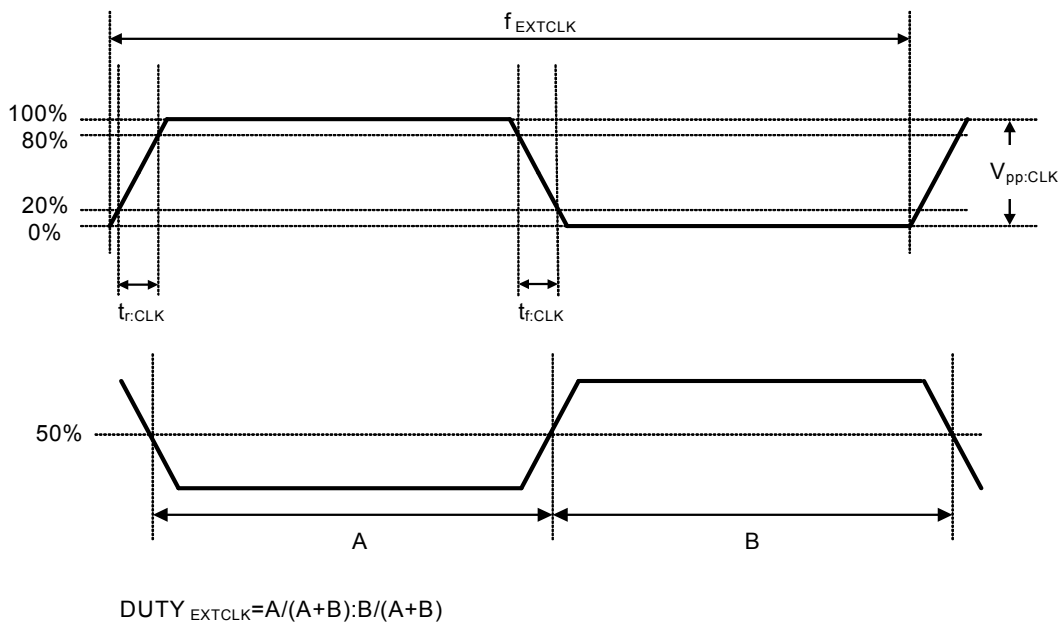

Figure 9 EXTCLK waveform (Square wave)

12.4.2. SDA and SCL

Items		Symbol	Min.	Max.	Unit	Notes
SCL	Clock frequency	f_{SCL}	0	400	KHz	*1
	Low period	$t_{LOW;SCL}$	1.3	-	μs	
	High period	$t_{HIGH;SCL}$	0.6	-	μs	
	Rise time	$t_{r;SCL}$	-	300	ns	
	Fall time	$t_{f;SCL}$	-	300	ns	
SDA	Rise time	$t_{r;SDA}$	-	300	ns	
	Fall time	$t_{f;SDA}$	-	300	ns	
Hold time(repeated) START condition After this period, the first clock pulse is generated		$t_{HD;STA}$	0.6	-	μs	
Setup time for a repeated START condition		$t_{SU;STA}$	0.6	-	μs	
Data hold time		$t_{HD;DAT}$	0	-	ns	
Data setup time		$t_{SU;DAT}$	100	-	ns	
Setup time for STOP condition		$t_{SU;STO}$	0.6	-	μs	
Width of spike pulse	Normal	t_{SP1}	0	50	ns	
	Wake-up from sleep mode	t_{SP2}	0	20	ns	

*1) All values referred to V_{IHmin} and V_{ILmax} levels

Table 10 SDA and SCL

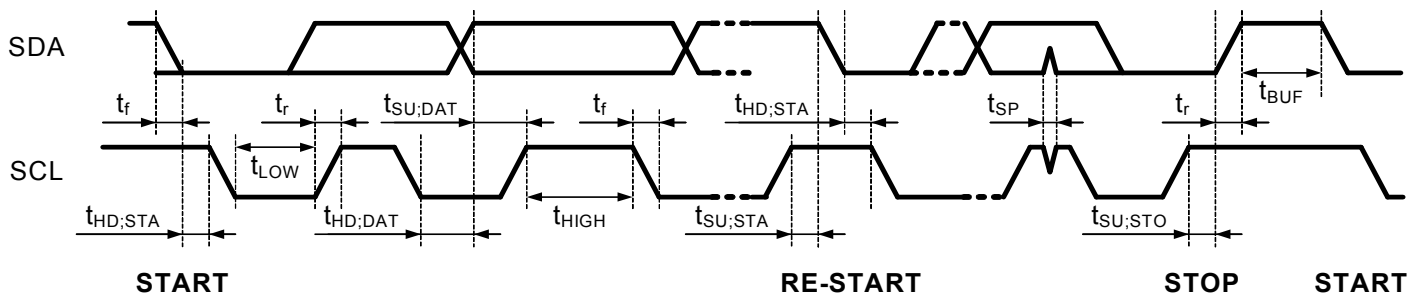

Figure 10 SDA and SCL

12.4.3. DATA7 to DATA0, DCLK, HSYNC and VSYNC

Items	Symble	Min.	Max.	Unit	Notes	
DCLK	Rise time	$t_{r,DCLK}$	-	6	ns	*1
	Fall time	$t_{f,DCLK}$	-	6	ns	
DATA0 to 7 HSYNC and VSYNC	Rise time	$T_{r,DATA}$	-	6	ns	
	Fall time	$t_{f,DATA}$	-	6	ns	
Setup time of data	$t_{pd,SU}$	10	-	ns		
Hold time of data	$t_{pd,HD}$	10	-	ns		

*1 All values referred to V_{OHmin} and V_{OLmax} levels.

Table 11 DCLK and DATA out

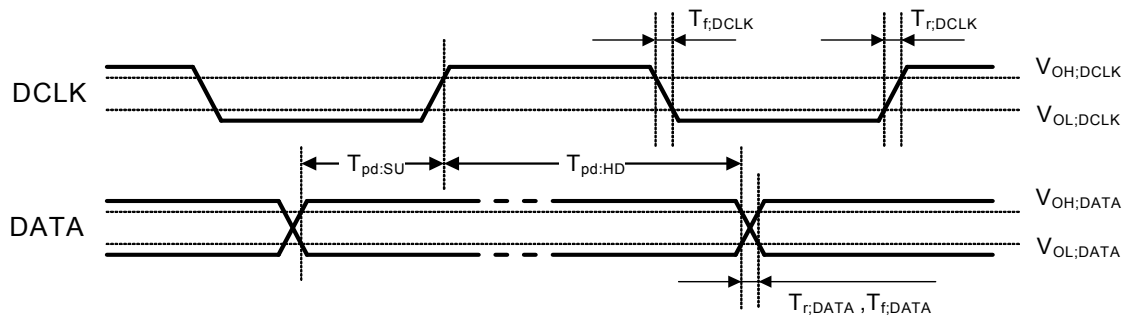

Figure 11 DCLK and DATA out

13. Reference of Application Circuit

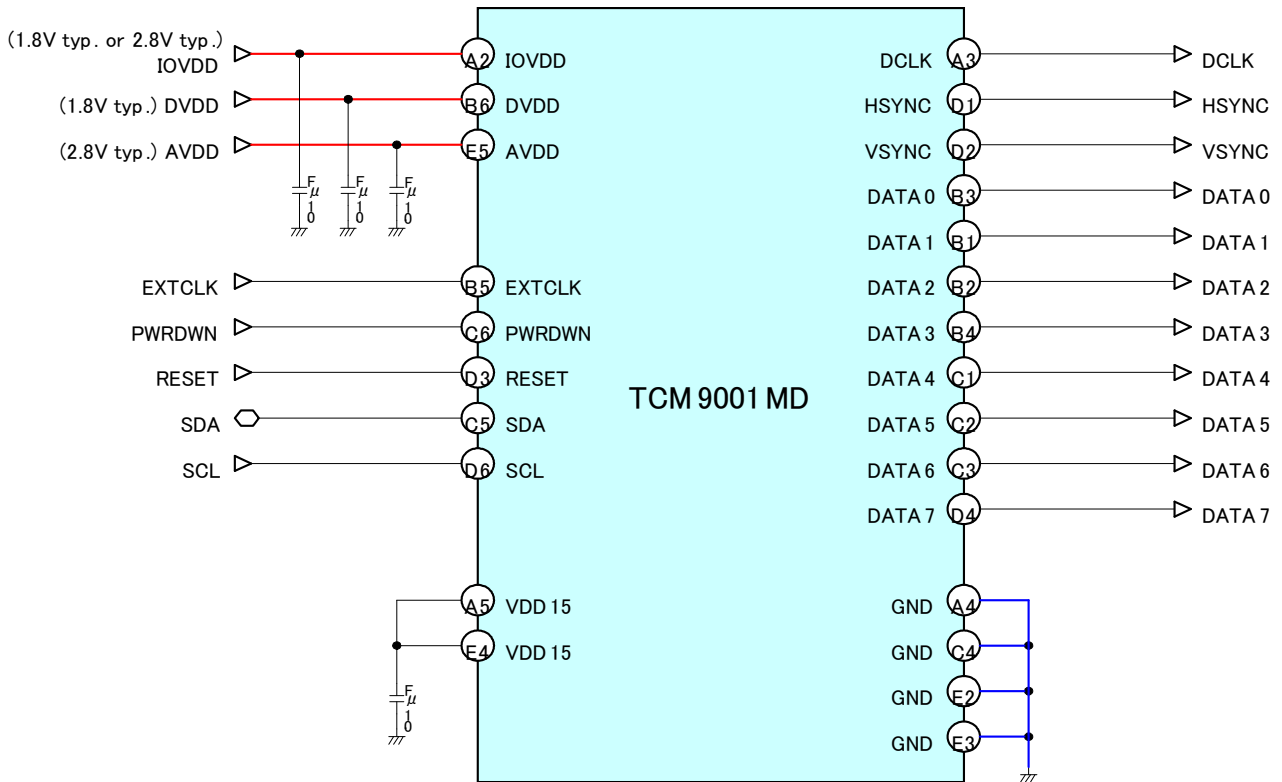

Figure 12 Reference of application circuit

14. Characteristics of Lens

ITEM		VALUE	UNITS
Optical format		1/10	inch
Field of view	Horizontal	-	degree
	Vertical	-	degree
	Diagonal	67.0	degree
F number		F2.8	-
TV distortion		-0.6	%
Focal length		1.3546	mm
Manual focusing		Fixed focus	-
Structure		Doublet lens	-

Note: The optical values are obtained by simulation.

Table 12 Characteristics of Lens

15. Module dimensions

Unit: mm

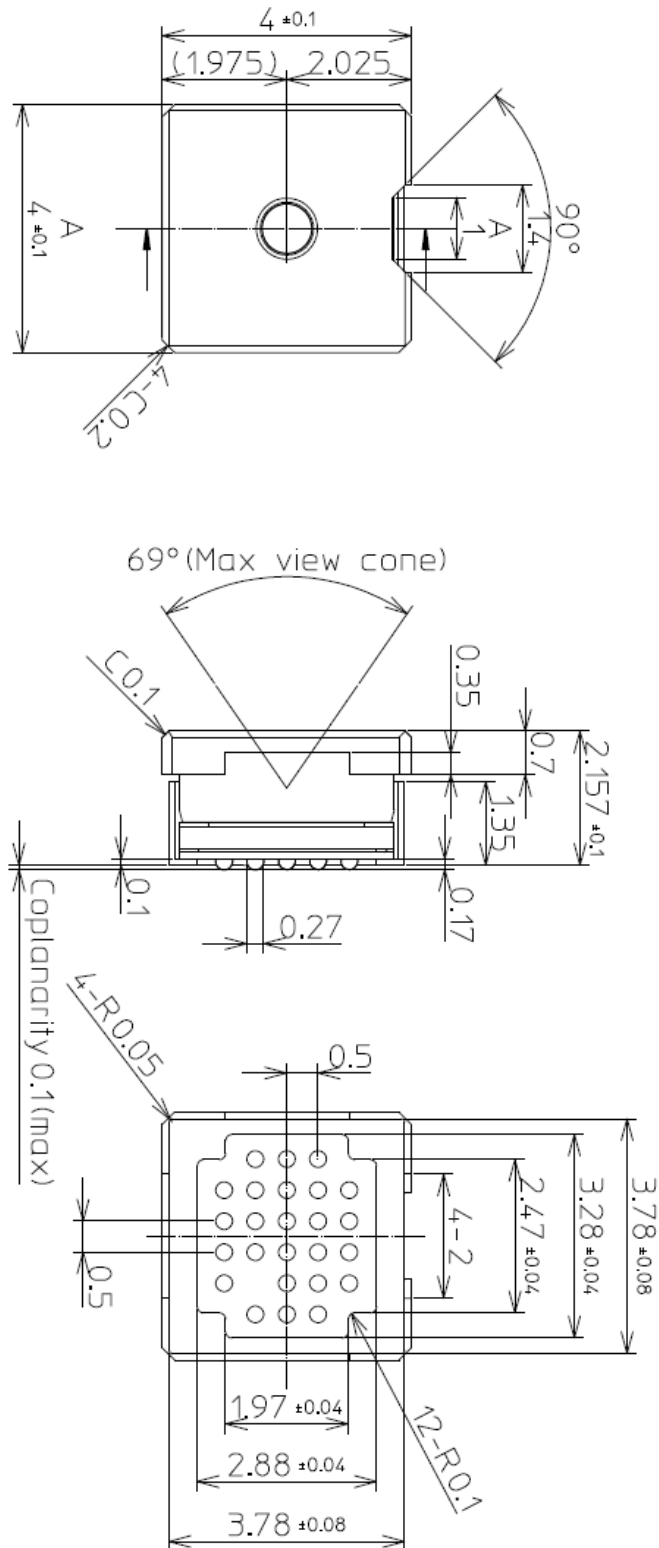

16. Instruction for the Camera Module handling

1. Use a wrist strap for human body grounding while at work.
2. Do not touch the surface of lens with finger or hand to keep the lens clean.
3. Do not put stress on the lens block to keep optical performance.
5. Do not drop the camera module on the floor which causes breaking and flaw.
5. Pick up the edge of lens holder with fingers carefully if it is necessary for the assembly by direct handling.
6. Do not expose to strong light, such as the sun for long periods. These will be influence the optical characteristics.

RESTRICTIONS ON PRODUCT USE

- The information contained herein subject to change without notice.
- The TOSHIBA is continuously working to improve the quality and reliability of its products. Nevertheless, semiconductor device in general can malfunction or fail due to their inherent electrical sensitivity and vulnerability to physical stress. It is the responsibility of the buyer, when utilizing TOSHIBA products, to comply with the standards of safety in marking a safe design for the entire system, and to avoid situations in which a malfunction or failure of such TOSHIBA products could cause loss of human life, bodily injury or damage to property.
In developing your designs, please ensure that TOSHIBA products are used within specified operating ranges as set forth in the most recent TOSHIBA products specifications. Also, please keep in mind the precautions and conditions set forth in the "Handling guide for Semiconductor devices", or "TOSHIBA Semiconductor Reliability Handbook" etc.
- The TOSHIBA products listed in this document are intended for usage in general electronics applications (computer, personal equipment, office equipment, measuring equipment, industrial robotics, domestic appliance, etc.). These TOSHIBA products are neither intended nor warranted for usage in equipment that requires extraordinarily high quality and/or reliability or a malfunction or failure of which may cause loss of human life or bodily injury ("Unintended Usage"). Unintended Usage include atomic energy control instruments, airplane or spaceship instruments, transportation instruments, traffic signal instruments, combustion control instruments, medical instruments, all type of safety devices, etc.. Unintended Usage of TOSIHBA products listed in this document shall be made at the customer's own risk.
- The products described in this document shall not be used or embedded to any downstream products of which manufacture, use and/or sale are prohibited under any applicable laws and regulations.
- The information contained herein is presented only as a guide for the applications of our products. No responsibility is assumed by TOSHIBA for any infringements of patents or other rights of the third parties which may result from its use. No license is granted by implication or otherwise under any patents or other rights of TOSHIBA or the third parties.
- Please use this product in compliance with all applicable laws and regulations that regulate the inclusion or use of controlled substances. Toshiba assumes no liability for damage or losses occurring as a result of noncompliance with applicable laws and regulations.
- The products described in this document are subject to foreign exchange and foreign trade control laws.

Revision History

Revision	Date	Comments
V0.1	Sep 29, 2008	New
V0.21	Dec 12, 2008	Amended the Characteristics of Lens in page 37. Amended the Module dimensions in page 38.