

KGG-MC 1,5/12

Order No.: 1834440

<http://eshop.phoenixcontact.de/phoenix/treeViewClick.do?UID=1834440>

Cable housing, for cable diameters of 4 - 11 mm, clamp, marker strips and transparent label carrier are included, color: green, no. of positions: 12

Commercial data	
EAN	4017918110789
Pack	10 Pcs.
Customs tariff	85369010
Weight/Piece	0.01195 KG
Catalog page information	Page 167 (CC-2007)

Product notesWEEE/RoHS-compliant since:
01/01/2003

<http://www.download.phoenixcontact.com>
Please note that the data given here has been taken from the online catalog. For comprehensive information and data, please refer to the user documentation. The General Terms and Conditions of Use apply to Internet downloads.

Accessories

Item	Designation	Description
------	-------------	-------------

Marking

1839050	KGG-MC 1,5/ DST	Transparent label carrier, can be marked with marker strips SBS 10
---------	-----------------	--

1007248	SBS10:UNBEDRUCKT	Marker cards, unprinted, for individual labeling with the M-PEN, 250-section, perforated, white plastic
---------	------------------	---

Drawings

Dimensioned drawing

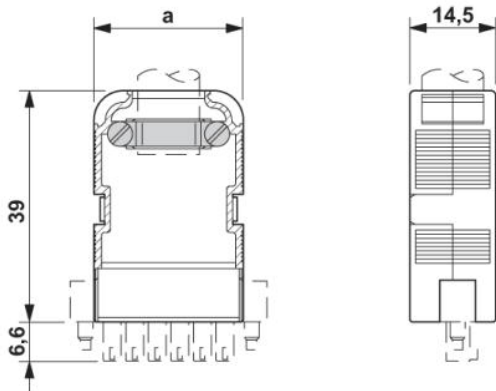

Address

PHOENIX CONTACT GmbH & Co. KG
Flachsmarktstr. 8
32825 Blomberg, Germany
Phone +49 5235 3 00
Fax +49 5235 3 41200
<http://www.phoenixcontact.de>



© 2008 Phoenix Contact
Technical modifications reserved;