

KGS-MSTB 2,5/12

Order No.: 1783818



<http://eshop.phoenixcontact.de/phoenix/treeViewClick.do?UID=1783818>

Cable housing, for cable diameters of 6 - 13.5 mm, marker strips and transparent label carrier are included, color: green, no. of positions: 12

Commercial data	
EAN	4017918041991
Pack	10 Pcs.
Customs tariff	85472000
Weight/Piece	0.02004 KG
Catalog page information	Page 249 (CC-2007)

Product notes

WEEE/RoHS-compliant since: 01/01/2003



<http://www.download.phoenixcontact.com>
Please note that the data given here has been taken from the online catalog. For comprehensive information and data, please refer to the user documentation. The General Terms and Conditions of Use apply to Internet downloads.

Accessories

Item	Designation	Description
Cable/conductor		
1804658	KD-KGS-MSTB	Molded cable strain relief, suitable for KGS-... cable housings, prevents the cable from being bent

Marking

1784914	KGS-MSTB 2,5/ DST	Transparent label carrier, can be marked with marker strips SBS 2.5/7.5
1007604	SBS 2,5/7,5	Marker strips, unprinted, for individual labeling, perforated, white plastic, 10-section, lettering field size: 15 x 7.5 mm

Drawings

Dimensioned drawing

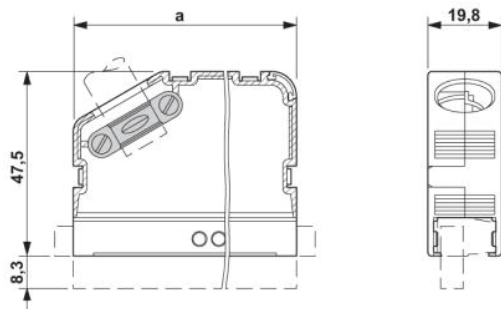

Address

PHOENIX CONTACT GmbH & Co. KG
Flachmarktstr. 8
32825 Blomberg, Germany
Phone +49 5235 3 00
Fax +49 5235 3 41200
<http://www.phoenixcontact.de>



© 2008 Phoenix Contact
Technical modifications reserved;