

# MM58167B

## Microprocessor Real Time Clock

### General Description

The MM58167B is a low threshold metal gate CMOS circuit that functions as a real time clock in bus oriented microprocessor systems. The device includes an addressable real time counter, 56 bits of RAM, and two interrupt outputs. A **POWER DOWN** input allows the chip to be disabled from the rest of the system for standby low power operation. The time base is a 32.768 kHz crystal oscillator.

### Features

- Microprocessor compatible (8-bit data bus)
- Milliseconds through month counters

- 56 bits of RAM with comparator to compare the real time counter to the RAM data
- 2 INTERRUPT OUTPUTS with 8 possible interrupt signals
- **POWER DOWN** input that disables all inputs and outputs except for one of the interrupts
- Status bit to indicate rollover during a read
- 32.768 kHz crystal oscillator
- Four-year calendar (no leap year)
- 24-hour clock

### Connection Diagrams

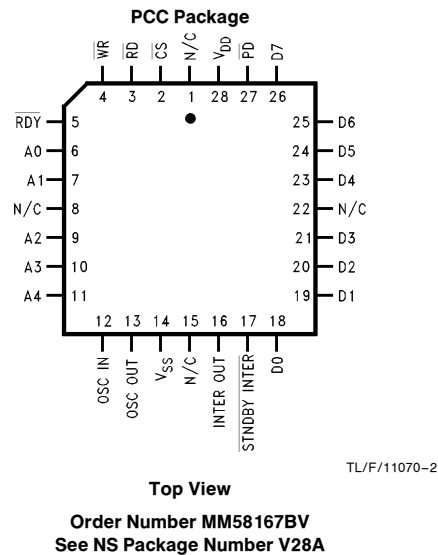
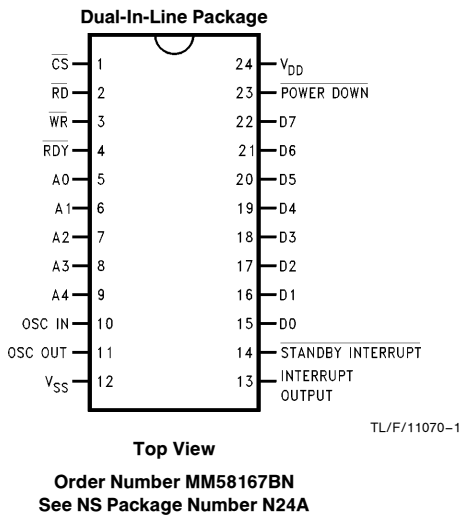

## Absolute Maximum Ratings

If Military/Aerospace specified devices are required, please contact the National Semiconductor Sales Office/Distributors for availability and specifications.

Voltage at All Pins  $V_{SS} - 0.3V$  to  $V_{DD} + 0.3V$   
 Operating Temperature  $0^{\circ}C$  to  $70^{\circ}C$

Storage Temperature  $-65^{\circ}C$  to  $+150^{\circ}C$   
 $V_{DD} - V_{SS}$  6.0V  
 Lead Temperature (Soldering, 10 sec.)  $300^{\circ}C$

## Electrical Characteristics $V_{SS} = 0V, 0^{\circ}C \leq T_A \leq 70^{\circ}C$

Parameter	Conditions	Min	Max	Units
Supply Voltage $V_{DD}$ $V_{DD}$	Outputs Enabled POWER DOWN Mode	4.5 2.2	5.5 5.5	V V
Supply Current $I_{DD}$ , Dynamic	Outputs TRI-STATE® $f_{IN} = 32.768$ kHz, $V_{DD} = 5.5V$ $V_{IH} \geq V_{DD} - 0.3V$ $V_{IL} \leq V_{SS} + 0.3V$		20	$\mu A$
$I_{DD}$ , Dynamic	Outputs TRI-STATE $f_{IN} = 32.768$ kHz, $V_{DD} = 5.5V$ $V_{IH} = 2.0V, V_{IL} = 0.8V$		5	mA
Input Voltage Logical Low Logical high		0.0 2.0	0.8 $V_{DD}$	V V
Input Leakage Current	$V_{SS} \leq V_{IN} \leq V_{DD}$	-1	1	$\mu A$
Output Impedance Logical Low Logical High TRI-STATE	I/O and INTERRUPT OUT $V_{DD} = 4.5V, I_{OL} = 1.6$ mA $V_{DD} = 4.5V, I_{OH} = -400$ $\mu A$ $I_{OH} = -10$ $\mu A$ $V_{SS} \leq V_{OUT} \leq V_{DD}$		0.4 2.4 $0.8 V_{DD}$ -1	V V V $\mu A$
Output Impedance Logical Low, Sink Logical High, Leakage	$\overline{RDY}$ and $\overline{STANDBY INTERRUPT}$ (Open Drain Devices) $V_{DD} = 4.5V, I_{OL} = 1.6$ mA $V_{OUT} \leq V_{DD}$		0.4 10	V $\mu A$

## Functional Description

### Real Time Counter

The real time counter is divided into 4-bit digits with 2 digits being accessed during any read or write cycle. Each digit represents a BCD number and is defined in Table I. Any unused bits are held at a logical zero during a read and ignored during a write. An unused bit is any bit not necessary to provide a full BCD number. For example tens of hours cannot legally exceed the number 2, thus only 2 bits are necessary to define the tens of hours. The other 2 bits in the tens of hours digit are unused. The unused bits are designated in Table I as dashes.

The addressable portion of the counter is from milliseconds to months. The counter itself is a ripple counter. The ripple delay is less than 60  $\mu$ s above 4.5V and 300  $\mu$ s at 2.2V.

### RAM

56 bits of RAM are contained on-chip. These can be used for any necessary power down storage or as an alarm latch for comparison to the real time counter. The data in the RAM can be compared to the real time counter on a digit basis. The only digits that are not compared are the unit ten thousandths of seconds and tens of days of the week (these are unused in the real time counter). If the two most significant bits of any RAM digit are ones, then this RAM location will always compare. The rule of thumb for an "alarm" interrupt is: All nibbles of higher order than specified are set to C hex (always compare). All nibbles lower than specified are set to "zero". As an example, if an alarm is to occur everyday at 10:15 a.m., configure the bits in RAM as shown in Table II.

The RAM is formatted the same as the real time counter, 4 bits per digit, 14 digits, however there are no unused bits.

The unused bits in the real time counter will compare only to zeros in the RAM.

An address map is shown in Table III.

### Interrupts and Comparator

There are two interrupt outputs. The first is the INTERRUPT OUTPUT (a true high signal). This output can be programmed to provide 8 different output signals. They are: 10 Hz, once per second, once per minute, once per hour, once a day, once a week, once a month, and when a RAM/real time counter comparison occurs. To enable the output a one is written into the interrupt control register at the bit location corresponding to the desired output frequency (*Figure 1*). Once one or more bits have been set in the interrupt control register, the corresponding counter's rollover to its reset state will clock the interrupt status register and cause the interrupt output to go high. To reset the interrupt and to identify which frequency caused the interrupt, the interrupt status register is read. Reading this register places the contents of the status register on the data bus. The interrupting frequency will be identified by a one in the respective bit position. Removing the read will reset the interrupt.

The second interrupt is the  $\overline{\text{STANDBY INTERRUPT}}$  (open drain output, active low). This interrupt occurs when enabled and when a RAM/real time counter comparison occurs. The  $\overline{\text{STANDBY INTERRUPT}}$  is enabled by writing a one on the D0 line at address 16<sub>H</sub> or disabled by writing a zero on the D0 line. This interrupt is not triggered by the edge of the compare signal, but rather by the level. Thus if the compare is enabled when the  $\overline{\text{STANDBY INTERRUPT}}$  is enabled, the interrupt will turn on immediately.

TABLE I. Real Time Counter Format

Counter Addressed		Units				Max BCD Code	Tens				Max BCD Code
		D0	D1	D2	D3		D4	D5	D6	D7	
Milliseconds	(00 <sub>H</sub> )	—	—	—	—	0	D4	D5	D6	D7	9
Hundredths and Tenths Sec	(01 <sub>H</sub> )	D0	D1	D2	D3	9	D4	D5	D6	D7	9
Seconds	(02 <sub>H</sub> )	D0	D1	D2	D3	9	D4	D5	D6	—	5
Minutes	(03 <sub>H</sub> )	D0	D1	D2	D3	9	D4	D5	D6	—	5
Hours	(04 <sub>H</sub> )	D0	D1	D2	D3	9	D4	D5	—	—	2
Day of the Week	(05 <sub>H</sub> )	D0	D1	D2	—	7	—	—	—	—	0
Day of the Month	(06 <sub>H</sub> )	D0	D1	D2	D3	9	D4	D5	—	—	3
Month	(07 <sub>H</sub> )	D0	D1	D2	D3	9	D4	—	—	—	1

(—) indicates unused bits

## Functional Description (Continued)

TABLE II. Clock RAM Bit Map for Alarm Interrupt Everyday at 10:15 a.m.

Function	Address					Data							
						Hi Nibble				Lo Nibble			
	4	3	2	1	0	7	6	5	4	3	2	1	0
Milliseconds	0	1	0	0	0	0	0	0	0	No RAM Exists			
Hundredths and Tenths of Seconds	0	1	0	0	1	0	0	0	0	0	0	0	0
Seconds	0	1	0	1	0	0	0	0	0	0	0	0	0
Minutes	0	1	0	1	1	0	0	0	1	0	1	0	1
Hours	0	1	1	0	0	0	0	0	1	0	0	0	0
Day of Week	0	1	1	0	1	No RAM Exists				1	1	X	X
Day of Month	0	1	1	1	0	1	1	X	X	1	1	X	X
Months	0	1	1	1	1	1	1	X	X	1	1	X	X

TABLE III. Address Codes and Function

A4	A3	A2	A1	A0	Function
0	0	0	0	0	Counter—Milliseconds
0	0	0	0	1	Counter—Hundredths and Tenths of Seconds
0	0	0	1	0	Counter—Seconds
0	0	0	1	1	Counter—Minutes
0	0	1	0	0	Counter—Hours
0	0	1	0	1	Counter—Day of Week
0	0	1	1	0	Counter—Day of Month
0	0	1	1	1	Counter—Month
0	1	0	0	0	RAM—Milliseconds
0	1	0	0	1	RAM—Hundredths and Tenths of Seconds
0	1	0	1	0	RAM—Seconds
0	1	0	1	1	RAM—Minutes
0	1	1	0	0	RAM—Hours
0	1	1	0	1	RAM—Day of Week
0	1	1	1	0	RAM—Day of Month
0	1	1	1	1	RAM—Months
1	0	0	0	0	Interrupt Status Register
1	0	0	0	1	Interrupt Control Register
1	0	0	1	0	Counters Reset
1	0	0	1	1	RAM Reset
1	0	1	0	0	Status Bit
1	0	1	0	1	GO Command
1	0	1	1	0	STANDBY INTERRUPT
1	1	1	1	1	Test Mode

All others unused

The comparator is a cascaded exclusive NOR. Its output is latched 61  $\mu$ s after the rising edge of the 1 kHz clock signal (input to the milliseconds counter). This allows the counter to ripple through before looking at the comparator. For operation at less than 4.5V, the thousandths of seconds counter should not be included in a compare because of the possibility of having a ripple delay greater than 61  $\mu$ s. (For output timing see Interrupt Timing.)

### Power Down Mode

The  $\overline{\text{POWER DOWN}}$  input is essentially a second chip select. It disables all inputs and outputs except for the  $\overline{\text{STANDBY INTERRUPT}}$ . When this input is at a logical zero, the device will not respond to any external signals. It will, however, maintain timekeeping and turn on the  $\overline{\text{STANDBY INTERRUPT}}$  if programmed to do so. (The programming must be done before the  $\overline{\text{POWER DOWN}}$  input goes to a

## Functional Description (Continued)

logical zero.) When switching  $V_{DD}$  to the standby or power down mode, the POWER DOWN input should go to a logical zero at least 1  $\mu$ s before  $V_{DD}$  is switched. When switching  $V_{DD}$  all other inputs must remain between  $V_{SS} - 0.3V$  and  $V_{DD} + 0.3V$ . When restoring  $V_{DD}$  to the normal operating mode, it is necessary to insure that all other inputs are at valid levels before switching the POWER DOWN input back to a logical one. These precautions are necessary to insure that no data is lost or altered when changing to or from the power down mode.

### Counter and RAM Resets; GO Command

The counters and RAM can be reset by writing all 1's (FF) at address 12<sub>H</sub> or 13<sub>H</sub> respectively.

A write pulse at address 15<sub>H</sub> will reset the thousandths, hundredths, tenths, units, and tens of seconds counters. This GO command is used for precise starting of the clock. The data on the data bus is ignored during the write. If the seconds counter is at a value greater than 39 when the GO is issued, the minute counter will increment; otherwise the minute counter is unaffected. This command is not necessary to start the clock, but merely a convenient way to start precisely at a given minute.

### Status Bit

The status bit is provided to inform the user that the clock is in the process of rolling over when a counter is read. The status bit is set if this 1 kHz clock occurs during or after any counter read. This tells the user that the clock is rippling through the real time counter. Because the clock is rippling, invalid data may be read from the counter. If the status bit is set following a counter read, the counter should be reread.

The status bit appears on D0 when address 14<sub>H</sub> is read. All the other data lines will zero. The bit is set when a logical one appears. This bit should be read every time a counter read or after a series of counter reads are done. The trailing edge of the read at address 14<sub>H</sub> will reset the status bit.

### Using the Rollover Status Bit

If a single read of any clock counter is made, it should be followed by reading the rollover status bit.

Example: Read months, then read rollover status.

If a sequential read of the clock counters is made, then the rollover status bit should be read after the last counter is read.

Example: Read hours, minutes, seconds, then read the rollover status.

### Oscillator

The oscillator used is the standard Pierce parallel resonant oscillator. Externally, 2 capacitors, a 20 M $\Omega$  resistor and the crystal are required. The 20 M $\Omega$  resistor is connected between OSC IN and OSC OUT to bias the internal inverter in the linear region. For micropower crystals a resistor in series with the oscillator output may be necessary to insure the crystal is not overdriven. This resistor should be approximately 200 k $\Omega$ . The capacitor values should be typically 20 pF–25 pF. The crystal frequency is 32,768 Hz.

The oscillator input can be externally driven, if desired. In this case the oscillator output should be left floating and the oscillator input levels should be within 0.3V of the supplies.

A ground line or ground plane between pins 9 and 10 may be necessary to reduce interference of the oscillator by the A4 address.

### Control Lines

The  $\overline{\text{READ}}$ ,  $\overline{\text{WRITE}}$ , AND  $\overline{\text{CHIP SELECT}}$  signals are active low inputs. The  $\overline{\text{READY}}$  signal is an open drain output. At the start of each read or write cycle the  $\overline{\text{READY}}$  line (open drain) will pull low and will remain low until valid data from a chip read appears on the bus or data on the bus is latched in during a write.  $\overline{\text{READ}}$  and  $\overline{\text{WRITE}}$  must be accompanied by a  $\overline{\text{CHIP SELECT}}$  (see Figures 3 and 4 for read and write cycle timing).

During a read or write, address bits must not change while chip select and control strobes are low.

### Test Mode

The test mode is for production testing. It allows the counters to count at a higher than normal rate. In this mode the 32.768 kHz oscillator input is connected directly to the ten thousandths of seconds counter. The chip select and write lines must be low and the address must be held at 1F<sub>H</sub>.

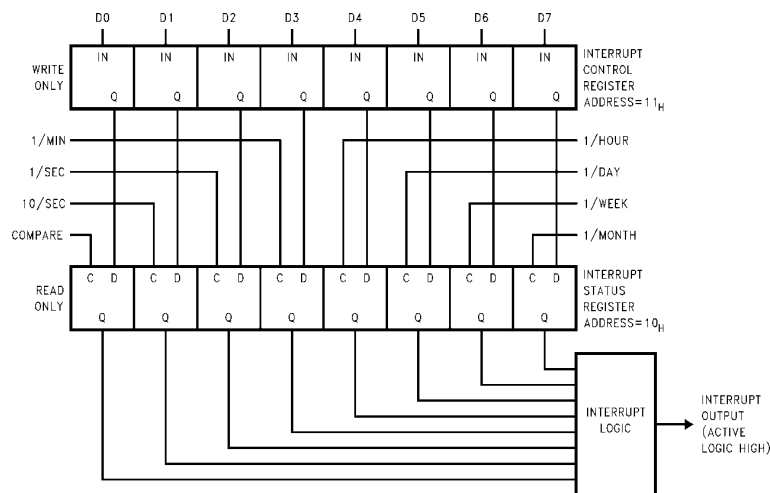
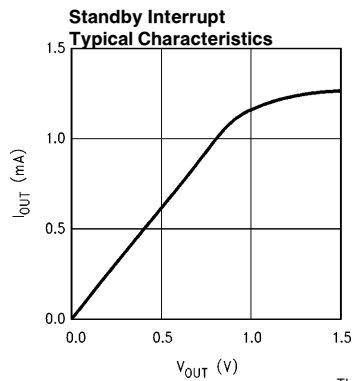

FIGURE 1. Interrupt Register Format

TL/F/11070-3

## Functional Description (Continued)



TL/F/11070-4

**FIGURE 2**

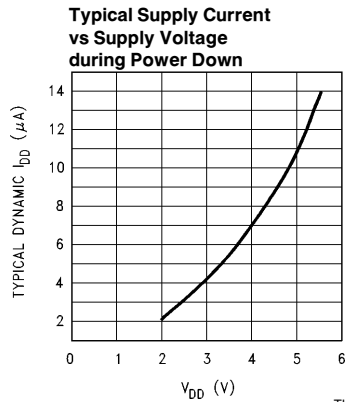

TL/F/11070-5

## Interrupt Timing $0^{\circ}\text{C} \leq T_A \leq 70^{\circ}\text{C}$ , $4.5\text{V} \leq V_{DD} \leq 5.5\text{V}$ , $V_{SS} = 0\text{V}$

Symbol	Parameter	Min	Max	Units
t <sub>INTON</sub>	Status Register Clock to INTERRUPT OUTPUT (Pin 13) High (Note 1)		5	µs
t <sub>SBYON</sub>	Compare Valid to $\overline{\text{STANDBY INTERRUPT}}$ (Pin 14) Low (Note 1)		5	µs
t <sub>INTOFF</sub>	Trailing Edge of Status Register Read to INTERRUPT OUTPUT Low		5	µs
t <sub>SBYOFF</sub>	Trailing Edge of Write Cycle (D0 = 0; Address = 16 <sub>H</sub> ) to $\overline{\text{STANDBY INTERRUPT}}$ Off (High Impedance State)		5	µs

**Note 1:** The status register clocks are: the corresponding counter's rollover to its reset state or the compare becoming valid. The compare becomes valid 61 µs after the 1/10,000 of a second counter is clocked, if the real time counter data matches the RAM data.

## Read Cycle Timing $0^{\circ}\text{C} \leq T_A \leq 70^{\circ}\text{C}$ , $4.5\text{V} \leq V_{DD} \leq 5.5\text{V}$ , $V_{SS} = 0\text{V}$

Symbol	Parameter	Min	Max	Units
t <sub>AR</sub>	Address Bus Valid to Read Strobe (Note 3)	100		ns
t <sub>CSR</sub>	Chip Select to Read Strobe (Note 2)	0		ns
t <sub>RRY</sub>	Read Strobe to Ready Strobe		150	ns
t <sub>RYD</sub>	Ready Strobe to Data Valid		800	ns
t <sub>AD</sub>	Address Bus Valid to Data Valid		1050	ns
t <sub>RH</sub>	Data Hold Time from Trailing Edge of Read Strobe	0		ns
t <sub>HZ</sub>	Trailing Edge of Read Strobe to TRI-STATE Mode		250	ns
t <sub>RYH</sub>	Read Hold Time after Ready Strobe	0		ns
t <sub>RA</sub>	Address Bus Hold Time from Trailing Edge of Read Strobe	50		ns
t <sub>RYDV</sub>	Rising Edge of Ready to Data Valid		100	ns

**Note 2:** When reading, a deselect time of 500 ns minimum must occur between counter reads. Deselect is:  $\overline{\text{CS}} = 1$  or  $(\overline{\text{WR}}) \bullet (\overline{\text{RD}}) = 1$ .

**Note 3:** If t<sub>AR</sub> = 0 and Chip Select, Address Valid or Read are coincident then they must exist for 1050 ns.

### Write Cycle Timing $0^{\circ}\text{C} \leq T_A \leq 70^{\circ}\text{C}$ , $4.5\text{V} \leq V_{DD} \leq 5.5\text{V}$ , $V_{SS} = 0\text{V}$

Symbol	Parameter	Min	Max	Units
$t_{AW}$	Address Valid to Write Strobe	100		ns
$t_{CSW}$	Chip Select to Write Strobe	0		ns
$t_{DW}$	Data Valid before Write Strobe	100		ns
$t_{WRY}$	Write Strobe to Ready Strobe		150	ns
$t_{RY}$	Ready Strobe Width		800	ns
$t_{RYH}$	Write Hold Time after Ready Strobe	0		ns
$t_{WD}$	Data Hold Time after Write Strobe	110		ns
$t_{WA}$	Address Hold Time after Write Strobe	50		ns

**Note 4:** If data changes while  $\overline{CS}$  and  $\overline{WR}$  are low, then they must remain coincident for 1050 ns after the data change to ensure a valid write. Data bus loading is 100 pF. Ready output loading is 50 pF and 3 k $\Omega$  pull-up.

Input and output AC timing levels:

Logical one = 2.0V

Logical zero = 0.8V

### Read and Write Cycle Timing Diagrams

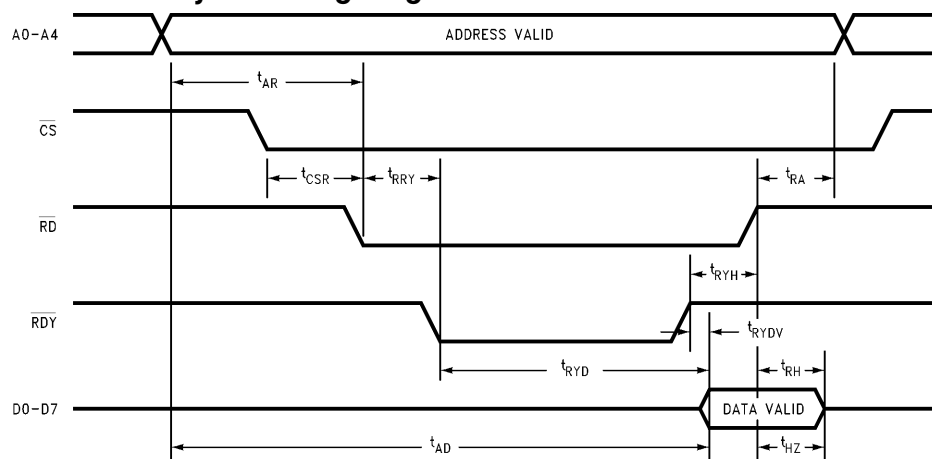

FIGURE 3. Read Cycle Timing

TL/F/11070-6

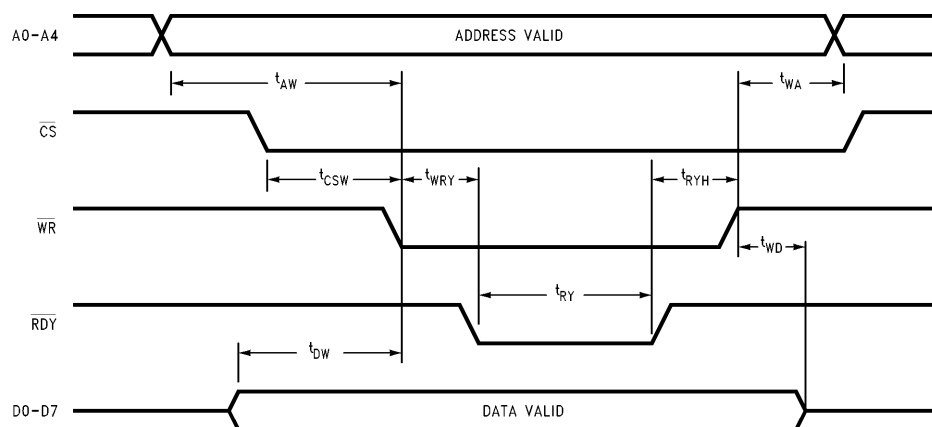

FIGURE 4. Write Cycle Timing

TL/F/11070-7





### Block Diagram

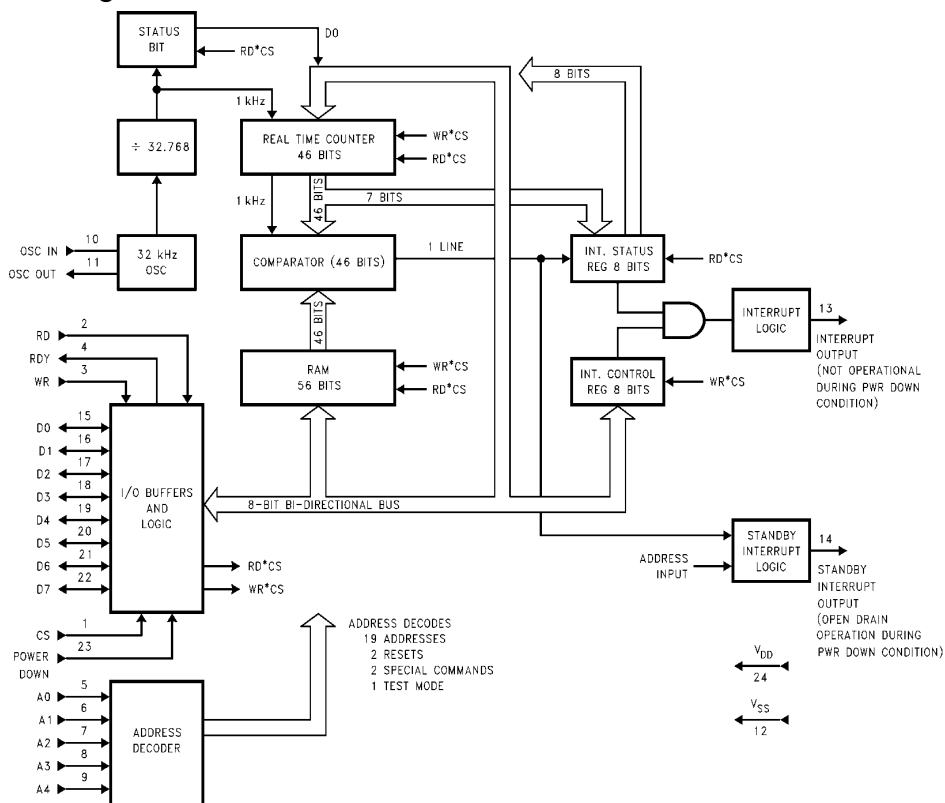
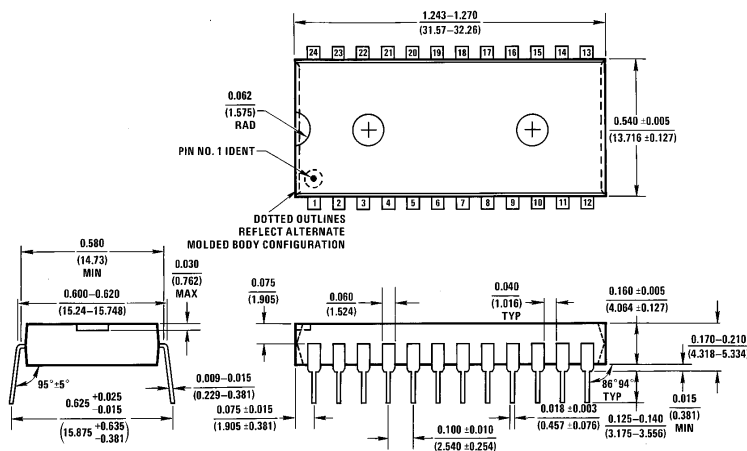

FIGURE 7

TL/F/11070-10

### Physical Dimensions inches (millimeters)



Molded Dual-In-Line Package (N)  
Order Number MM58167BN  
NS Package Number N24A

N24A (REV E)

**Physical Dimensions** inches (millimeters) (Continued)

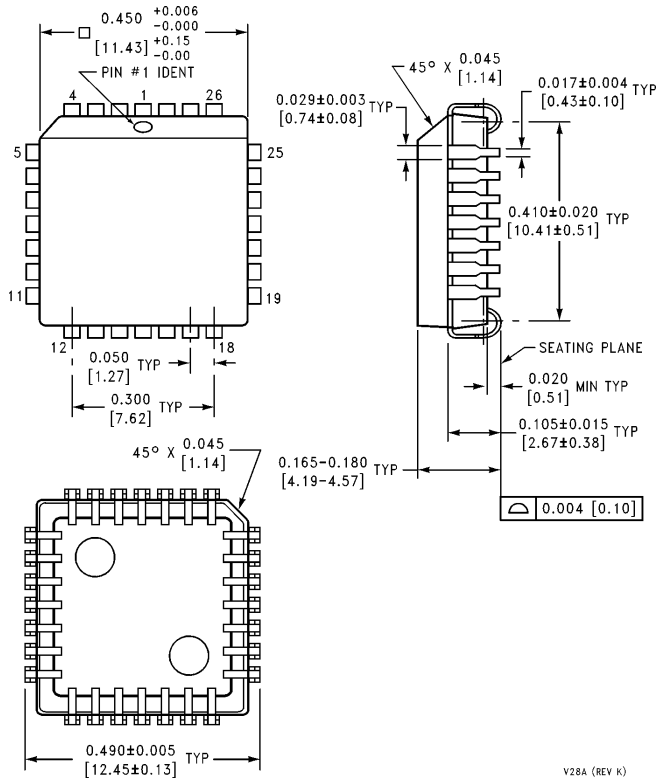

**PCC Package (V)**  
**Order Number MM58167BV**  
**NS Package Number V28A**

V28A (REV K)

**LIFE SUPPORT POLICY**

NATIONAL'S PRODUCTS ARE NOT AUTHORIZED FOR USE AS CRITICAL COMPONENTS IN LIFE SUPPORT DEVICES OR SYSTEMS WITHOUT THE EXPRESS WRITTEN APPROVAL OF THE PRESIDENT OF NATIONAL SEMICONDUCTOR CORPORATION. As used herein:

1. Life support devices or systems are devices or systems which, (a) are intended for surgical implant into the body, or (b) support or sustain life, and whose failure to perform, when properly used in accordance with instructions for use provided in the labeling, can be reasonably expected to result in a significant injury to the user.
2. A critical component is any component of a life support device or system whose failure to perform can be reasonably expected to cause the failure of the life support device or system, or to affect its safety or effectiveness.



**National Semiconductor Corporation**  
 1111 West Bardin Road  
 Arlington, TX 76017  
 Tel: 1(800) 272-9959  
 Fax: 1(800) 737-7018

**National Semiconductor Europe**  
 Fax: (+49) 0-180-530 85 86  
 Email: cnjwge@tevm2.nsc.com  
 Deutsch Tel: (+49) 0-180-530 85 85  
 English Tel: (+49) 0-180-532 78 32  
 Français Tel: (+49) 0-180-532 93 58  
 Italiano Tel: (+49) 0-180-534 16 80

**National Semiconductor Hong Kong Ltd.**  
 19th Floor, Straight Block,  
 Ocean Centre, 5 Canton Rd.  
 Tsimshatsui, Kowloon  
 Hong Kong  
 Tel: (852) 2737-1600  
 Fax: (852) 2736-9960

**National Semiconductor Japan Ltd.**  
 Tel: 81-043-299-2309  
 Fax: 81-043-299-2408

National does not assume any responsibility for use of any circuitry described, no circuit patent licenses are implied and National reserves the right at any time without notice to change said circuitry and specifications.