

### PHASE CONTROL THYRISTORS

Stud Version

80A

#### Features

- All diffused design
- Glass-metal seal up to 1200V
- International standard case TO-209AC (TO-94)
- Threaded studs UNF 1/2 - 20UNF2A or ISO M12x1.75

#### Typical Applications

- DC motor controls
- Controlled DC power supplies
- AC controllers

#### Major Ratings and Characteristics

Parameters	80RIA	Unit
$I_{T(AV)}$	80	A
	@ $T_C$	85 °C
$I_{T(RMS)}$	125	A
$I_{TSM}$	@ 50Hz	1900 A
	@ 60Hz	1990 A
$I^2t$	@ 50Hz	18 KA <sup>2</sup> s
	@ 60Hz	16 KA <sup>2</sup> s
$V_{DRM}/V_{RRM}$	400 to 1200	V
$t_q$ typical	110	μs
$T_J$	- 40 to 125	°C

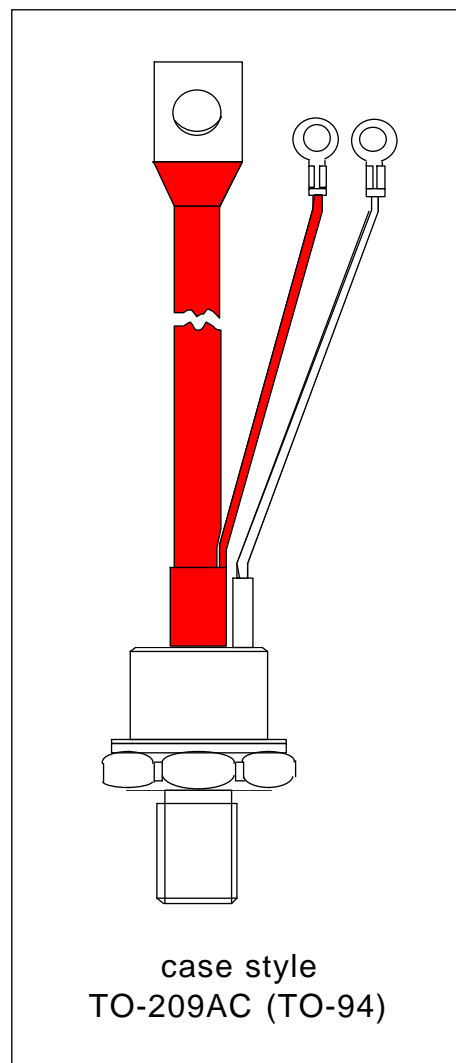

## 80RIA Series

### ELECTRICAL SPECIFICATIONS

#### Voltage Ratings

Type number	Voltage Code	$V_{DRM}/V_{RRM}$ , max. repetitive peak and off-state voltage V	$V_{RSM}$ , maximum non-repetitive peak voltage V	$I_{DRM}/I_{RRM}$ max. @ $T_J = 125^\circ\text{C}$ mA
80RIA	40	400	500	15
	80	800	900	
	120	1200	1300	

#### On-state Conduction

Parameter	80RIA	Units	Conditions
$I_{T(AV)}$ Max. average on-state current @ Case temperature	80	A	180° conduction, half sine wave
	85	°C	
$I_{T(RMS)}$ Max. RMS on-state current	125	A	DC @ 75°C case temperature
$I_{TSM}$ Max. peak, one-cycle non-repetitive surge current	1900	A	t = 10ms No voltage reappplied
	1990		t = 8.3ms
	1600		t = 10ms 100% $V_{RRM}$ reappplied
	1675		t = 8.3ms
$I^2t$ Maximum $I^2t$ for fusing	18	$\text{KA}^2\text{s}$	t = 10ms No voltage reappplied
	16		t = 8.3ms
	12.7		t = 10ms 100% $V_{RRM}$ reappplied
	11.7		t = 8.3ms
$I^2\sqrt{t}$ Maximum $I^2\sqrt{t}$ for fusing	180.5	$\text{KA}^2\sqrt{\text{s}}$	t = 0.1 to 10ms, no voltage reappplied
$V_{T(TO)1}$ Low level value of threshold voltage	0.99	V	$(16.7\% \times \pi \times I_{T(AV)} < I < \pi \times I_{T(AV)})$ , $T_J = T_J \text{ max.}$
$V_{T(TO)2}$ High level value of threshold voltage	1.13		$(I > \pi \times I_{T(AV)})$ , $T_J = T_J \text{ max.}$
$r_{t1}$ Low level value of on-state slope resistance	2.29	$\text{m}\Omega$	$(16.7\% \times \pi \times I_{T(AV)} < I < \pi \times I_{T(AV)})$ , $T_J = T_J \text{ max.}$
$r_{t2}$ High level value of on-state slope resistance	1.84		$(I > \pi \times I_{T(AV)})$ , $T_J = T_J \text{ max.}$
$V_{TM}$ Max. on-state voltage	1.60	V	$I_{pk} = 250\text{A}$ , $T_J = 25^\circ\text{C}$ $t_p = 10\text{ms}$ sine pulse
$I_H$ Maximum holding current	150	mA	$T_J = 25^\circ\text{C}$ , anode supply 12V resistive load
$I_L$ Typical latching current	400		

## Switching

Parameter	80RIA	Units	Conditions
di/dt Max. non-repetitive rate of rise of turned-on current	300	A/ $\mu$ s	$T_J = 125^\circ\text{C}$ , $V_d = \text{rated } V_{\text{DRM}}$ , $I_{\text{TM}} = 2 \times \text{di/dt}$ snubber 0.2 $\mu$ F, 15 $\Omega$ , Gate pulse: 20V, 65 $\Omega$ , $t_p = 6\mu\text{s}$ , $t_r = 0.5\mu\text{s}$ Per JEDEC Standard RS-397, 5.2.2.6.
$t_d$ Typical delay time	1	$\mu$ s	Gate pulse: 10V, 15 $\Omega$ source, $t_p = 6\mu\text{s}$ , $t_r = 0.1\mu\text{s}$ , $V_d = \text{rated } V_{\text{DRM}}$ , $I_{\text{TM}} = 50\text{A}$ , $T_J = 25^\circ\text{C}$ .
$t_q$ Typical turn-off time	110		$I_{\text{TM}} = 50\text{A}$ , $T_J = T_J \text{ max}$ , $\text{di/dt} = -5\text{A}/\mu\text{s}$ min., $V_R = 50\text{V}$ , $\text{dv/dt} = 20\text{V}/\mu\text{s}$ , Gate bias: 0V 25 $\Omega$ , $t_p = 500\mu\text{s}$

## Blocking

Parameter	80RIA	Units	Conditions
dv/dt Maximum critical rate of rise of off-state voltage	500	V/ $\mu$ s	$T_J = 125^\circ\text{C}$ exponential to 67% rated $V_{\text{DRM}}$
$I_{\text{RRM}}$ $I_{\text{DRM}}$ Max. peak reverse and off-state leakage current	15	mA	$T_J = 125^\circ\text{C}$ rated $V_{\text{DRM}}/V_{\text{RRM}}$ applied

## Triggering

Parameter	80RIA	Units	Conditions
$P_{\text{GM}}$ Maximum peak gate power	12	W	$T_J = T_J \text{ max}$ , $t_p \leq 5\text{ms}$
$P_{\text{G(AV)}}$ Maximum average gate power	3		$T_J = T_J \text{ max}$ , $f = 50\text{Hz}$ , $d\% = 50$
$I_{\text{GM}}$ Max. peak positive gate current	3	A	$T_J = T_J \text{ max}$ , $t_p \leq 5\text{ms}$
$+V_{\text{GM}}$ Maximum peak positive gate voltage	20	V	$T_J = T_J \text{ max}$ , $t_p \leq 5\text{ms}$
$-V_{\text{GM}}$ Maximum peak negative gate voltage	10		
$I_{\text{GT}}$ Max. DC gate current required to trigger	270	mA	Max. required gate trigger/ current/ voltage are the lowest value which will trigger all units 6V anode-to-cathode applied
	120		
	60		
$V_{\text{GT}}$ Max. DC gate voltage required to trigger	3.5	V	$T_J = -40^\circ\text{C}$ $T_J = 25^\circ\text{C}$ $T_J = 125^\circ\text{C}$
	2.5		
	1.5		
$I_{\text{GD}}$ DC gate current not to trigger	6	mA	$T_J = T_J \text{ max}$ Max. gate current/ voltage not to trigger is the max. value which will not trigger any unit with rated $V_{\text{DRM}}$ anode-to-cathode applied
$V_{\text{GD}}$ DC gate voltage not to trigger	0.25		

# 80RIA Series

## Thermal and Mechanical Specification

Parameter	80RIA	Units	Conditions
T <sub>J</sub> Max. operating temperature range	-40 to 125	°C	
T <sub>stg</sub> Max. storage temperature range	-40 to 150		
R <sub>thJC</sub> Max. thermal resistance, junction to case	0.30	K/W	DC operation
R <sub>thCS</sub> Max. thermal resistance, case to heatsink	0.1		Mounting surface, smooth, flat and greased
T Mounting torque, ± 10%	15.5 (137)	Nm (lbf-in)	Non lubricated threads
	14 (120)		Lubricated threads
wt Approximate weight	130	g	
Case style	TO-209AC(TO-94)		See Outline Table

### $\Delta R_{thJ-C}$ Conduction

(The following table shows the increment of thermal resistance  $R_{thJ-C}$  when devices operate at different conduction angles than DC)

Conduction angle	Sinusoidal conduction	Rectangular conduction	Units	Conditions
180°	0.042	0.030	K/W	T <sub>J</sub> = T <sub>J</sub> max.
120°	0.050	0.052		
90°	0.064	0.070		
60°	0.095	0.100		
30°	0.164	0.165		

## Ordering Information Table

Device Code	
<div style="display: flex; justify-content: center; gap: 10px;"> <div style="border: 1px solid black; padding: 5px; background-color: black; color: white; width: 30px; height: 30px; display: flex; align-items: center; justify-content: center;">8</div> <div style="border: 1px solid black; padding: 5px; background-color: black; color: white; width: 30px; height: 30px; display: flex; align-items: center; justify-content: center;">0</div> <div style="border: 1px solid black; padding: 5px; background-color: black; color: white; width: 30px; height: 30px; display: flex; align-items: center; justify-content: center;">RIA</div> <div style="border: 1px solid black; padding: 5px; background-color: black; color: white; width: 30px; height: 30px; display: flex; align-items: center; justify-content: center;">120</div> <div style="border: 1px solid black; padding: 5px; background-color: black; color: white; width: 30px; height: 30px; display: flex; align-items: center; justify-content: center;">M</div> </div> <div style="display: flex; justify-content: center; gap: 10px; margin-top: 5px;"> <span style="border: 1px solid black; border-radius: 50%; padding: 2px 5px;">1</span> <span style="border: 1px solid black; border-radius: 50%; padding: 2px 5px;">2</span> <span style="border: 1px solid black; border-radius: 50%; padding: 2px 5px;">3</span> <span style="border: 1px solid black; border-radius: 50%; padding: 2px 5px;">4</span> <span style="border: 1px solid black; border-radius: 50%; padding: 2px 5px;">5</span> </div>	<p><b>1</b> - I<sub>TAV</sub> x 10A</p> <p><b>2</b> - 0 = Eyelet terminals (Gate and Auxiliary Cathode Leads) 1 = Fast - on terminals (Gate and Auxiliary Cathode Leads) 2 = Flag terminals (For Cathode and Gate Terminals)</p> <p><b>3</b> - RIA = Essential part number</p> <p><b>4</b> - Voltage code: Code x 10 = V<sub>RRM</sub> (See Voltage Rating Table)</p> <p><b>5</b> - None = Stud base 1/2 "20UNF - 2A threads M = Stud base metric threads M12 x 1.75 E 6</p>

Outline Table

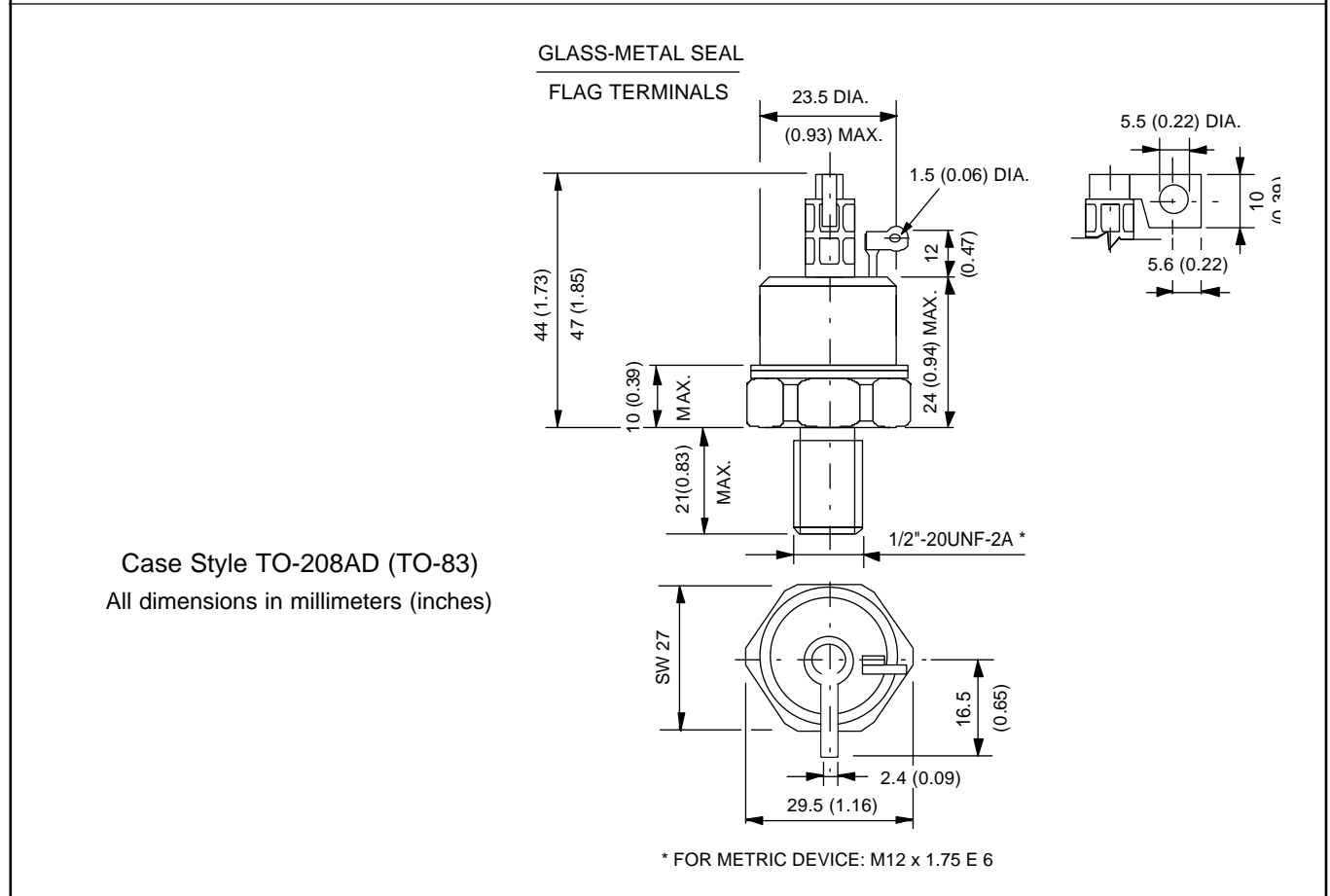
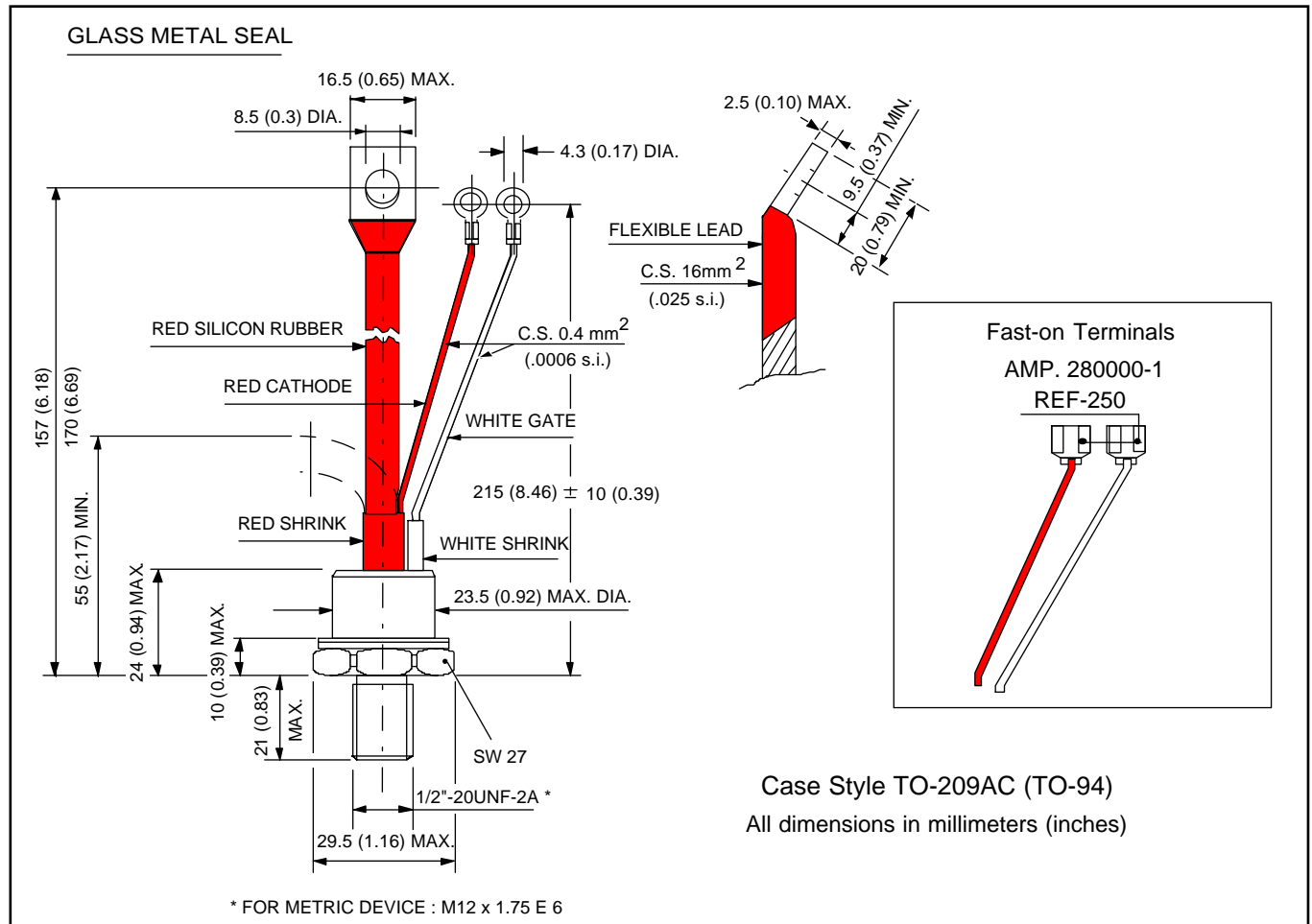

# 80RIA Series

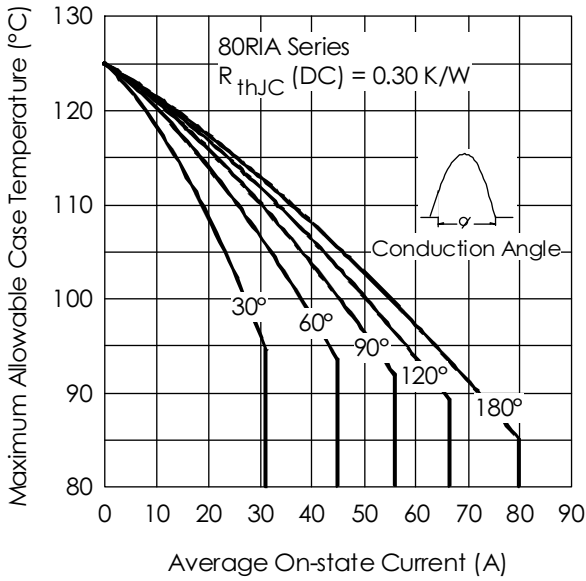

Fig. 1 - Current Ratings Characteristics

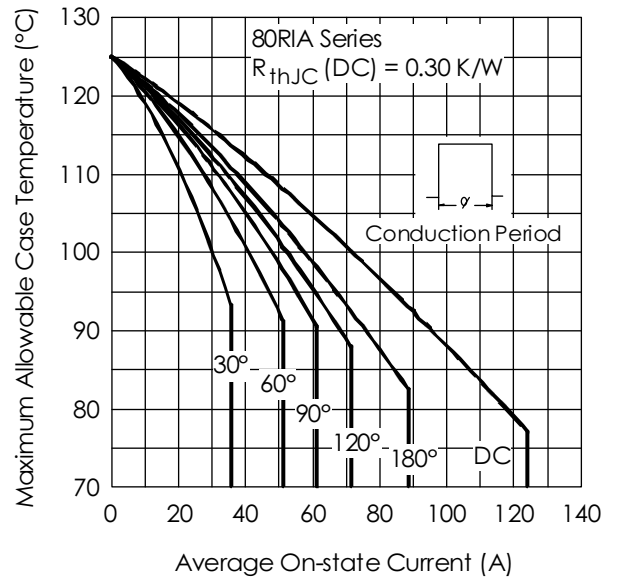

Fig. 2 - Current Ratings Characteristics

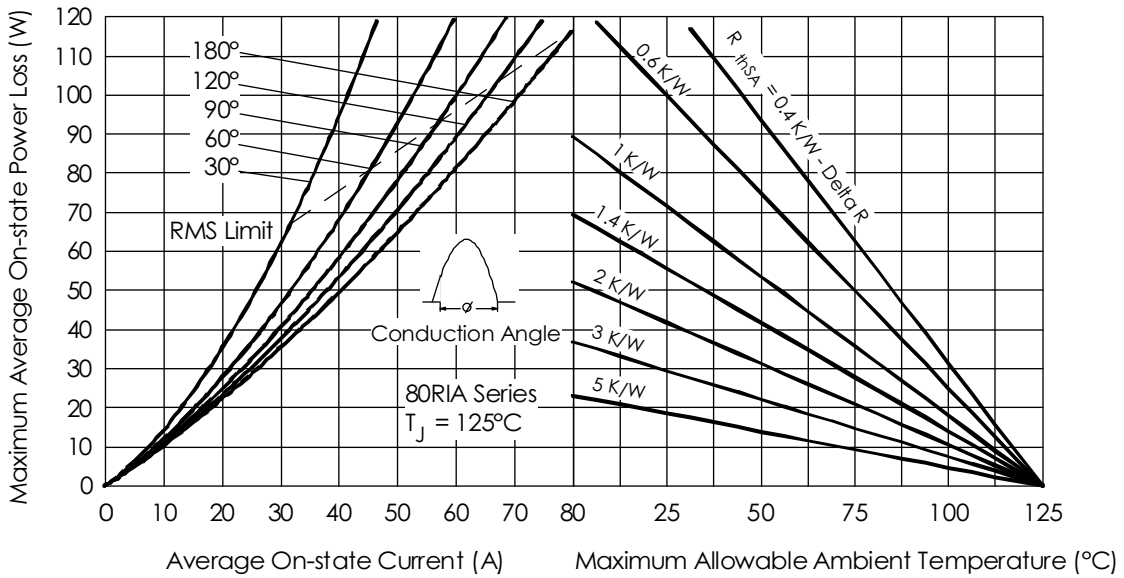

Fig. 3 - On-state Power Loss Characteristics

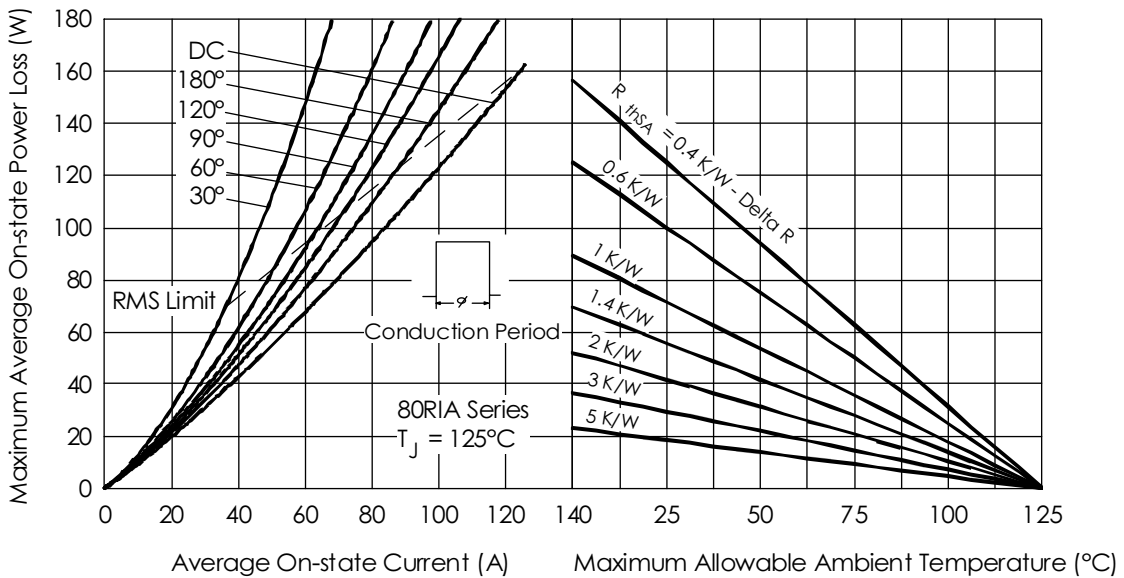

Fig. 4 - On-state Power Loss Characteristics

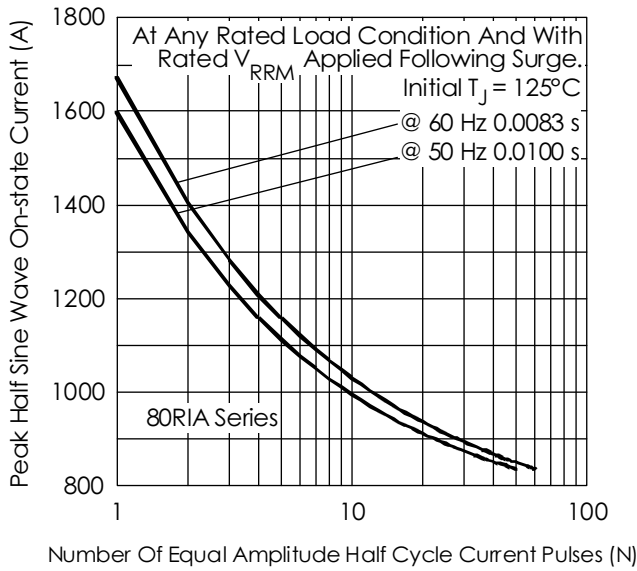

Fig. 5 - Maximum Non-Repetitive Surge Current

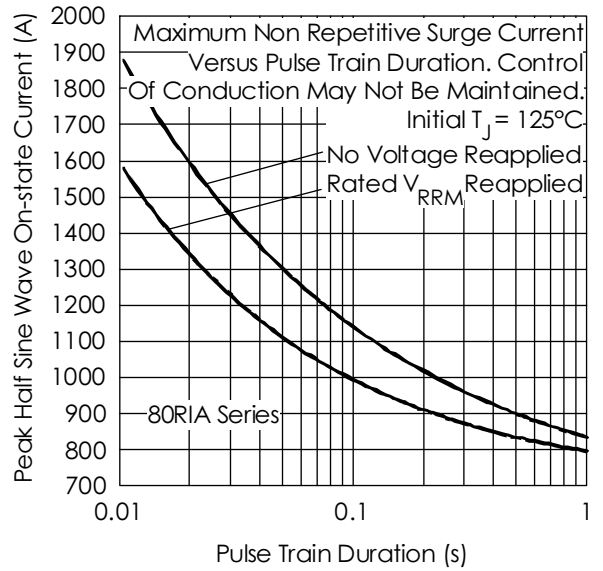

Fig. 6 - Maximum Non-Repetitive Surge Current

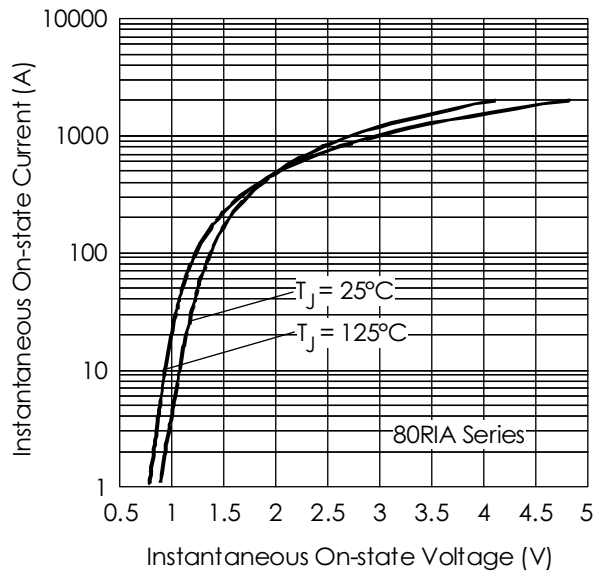

Fig. 7 - On-state Voltage Drop Characteristics

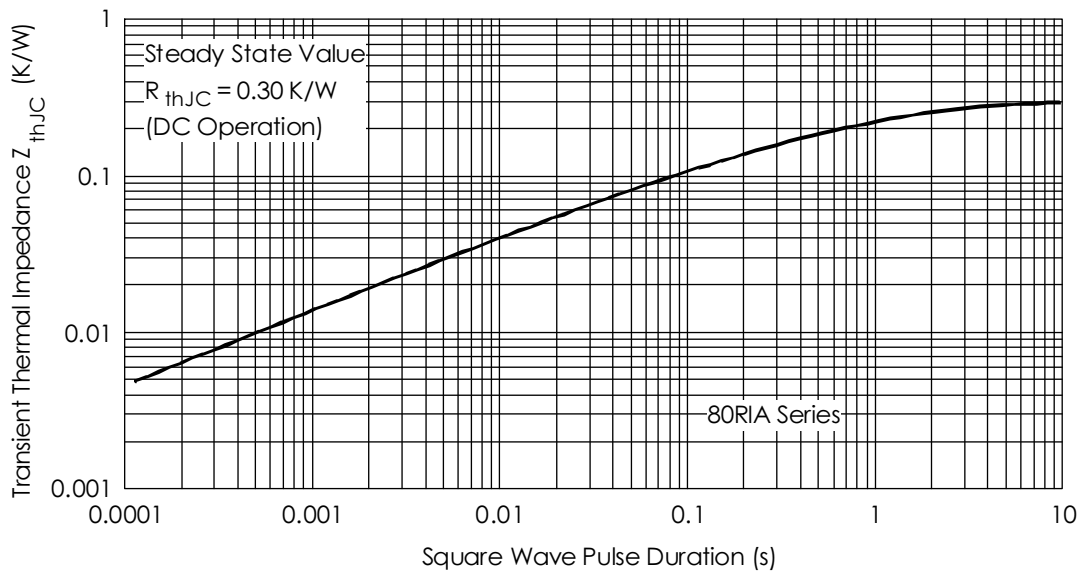

Fig. 8 - Thermal Impedance  $Z_{thJC}$  Characteristics

# 80RIA Series

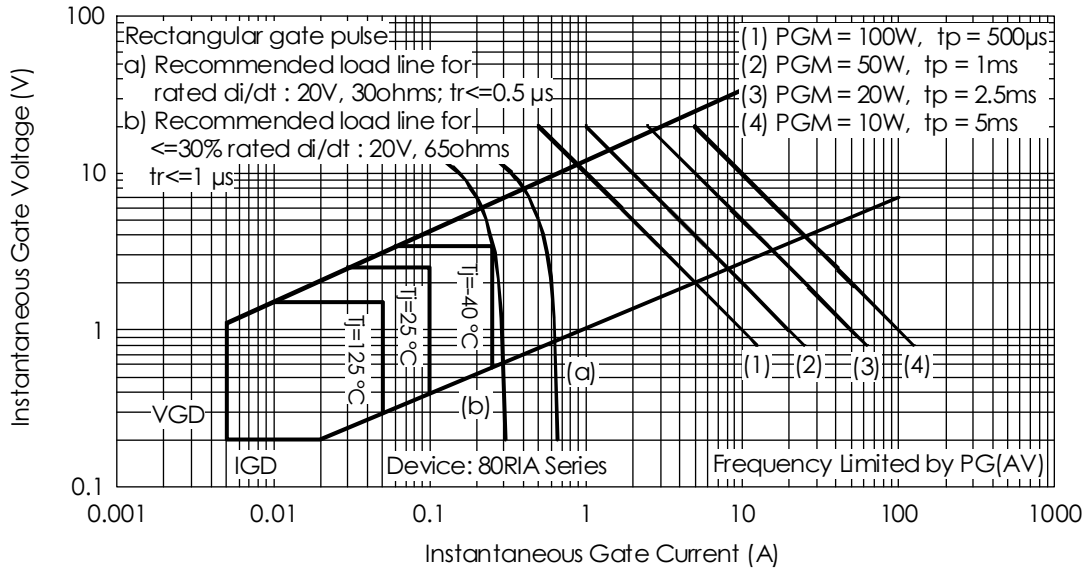

Fig. 9 - Gate Characteristics