

REV.	DESCRIPTION	DATE	APPROVED
A	Engineering Release.	05/04/05	M. C.

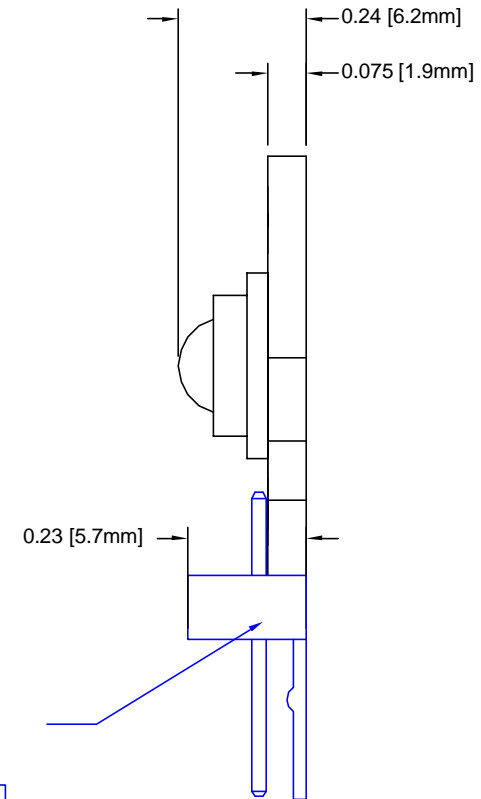
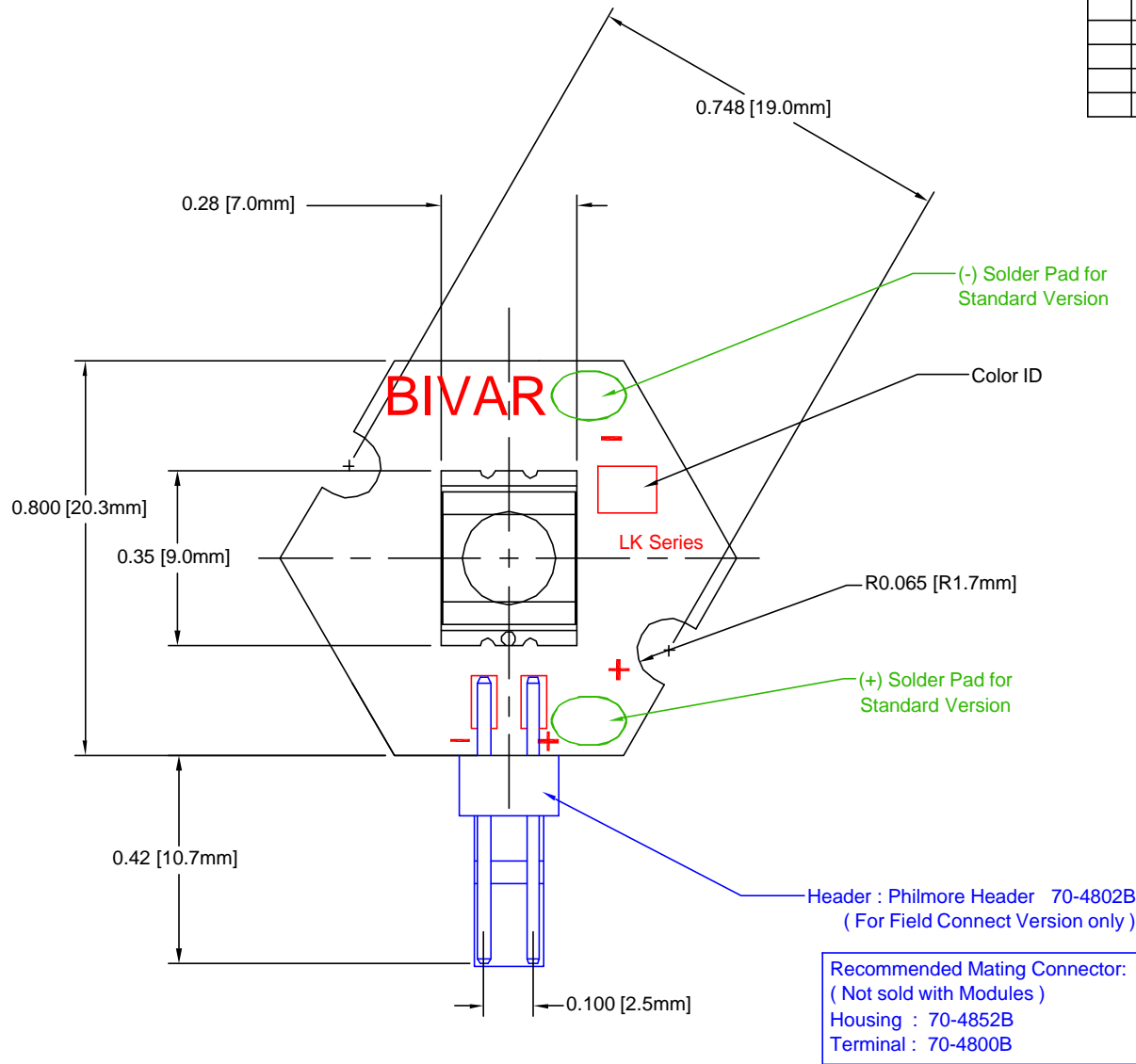

ABSOLUTE MAXIMUM RATINGS (Ta = 25°C)

REVERSE VOLTAGE	5V
REVERSE CURRENT (VR=5V)	100 μA
LED JUNCTION TEMPERATURE	125°C
OPERATING TEMPERATURE	-20°C ~ +80°C
STORAGE TEMPERATURE	-20°C ~ +100°C

STANDARD TOLERANCE (UNLESS OTHERWISE SPECIFIED)		BIVAR®	
DECIMALS	ANGULAR	4 THOMAS, IRVINE, CA. 92618	
.X ±.1	X° ±1°	TEL: (949) 951-8808 FAX: (949) 951-3974	
.XX ±.02		TITLE: 1W-LED Module	
.XXX ±.010		PART NO: LK-XXX-XXX-FC	
DESIGNED: Michael Chen	DATE: 05/04/05	REVISION: A	
CHECKED: T. Yin	DATE: 05/04/05	CAGE CODE : 32559 SHEET # 1 OF 5	
CAD GENERATED DOCUMENT. DO NOT MEASURE DRAWING.			

REV.	DESCRIPTION	DATE	APPROVED
	See Sheet #1 of 5.		

Part No.	Chip				Lens Appearance	Absolute Max. Rating			Electro-Optical Data @ 350mA				Viewing Angle 2θ ½
	Material	Dominant Wave Length λd (nm)		Emitted Color		Pd (W)	If (mA)	R _{thjs} (C°/W)	Vf (V)		Lum. Flux (lm)		
		Min.	Max.						Typ.	Max.	Min.	Max.	
LK-470-001	InGaN	465	475	Blue	Water Clear	1.6	400	17	3.3	4.0	6.3	23.5	100
LK-470-001-FC													
LK-530-001	InGaN	520	535	Green	Water Clear	1.6	400	17	3.3	4.0	30.6	67.2	100
LK-530-001-FC													
LK-590-001	AlInGaAlP	585	595	Amber	Water Clear	1.2	400	17	2.3	3.0	30.6	67.2	100
LK-590-001-FC													
LK-630-001	AlInGaAlP	620	635	Red	Water Clear	1.2	400	17	2.3	3.0	18.1	51.7	100
LK-630-001-FC													
LK-WHT-001	InGaN	4500K	8000K	White*	Water Clear	1.6	400	17	3.3	4.0	23.5	67.2	100
LK-WHT-001-FC													

Boundary Coordinates for White LED: X=0.279, Y=0.384
X=0.279, Y=0.284

X=0.348, Y=0.384
X=0.348, Y=0.284

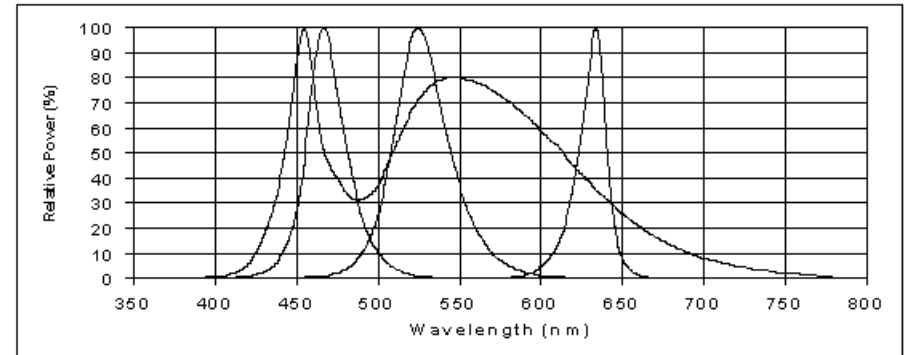
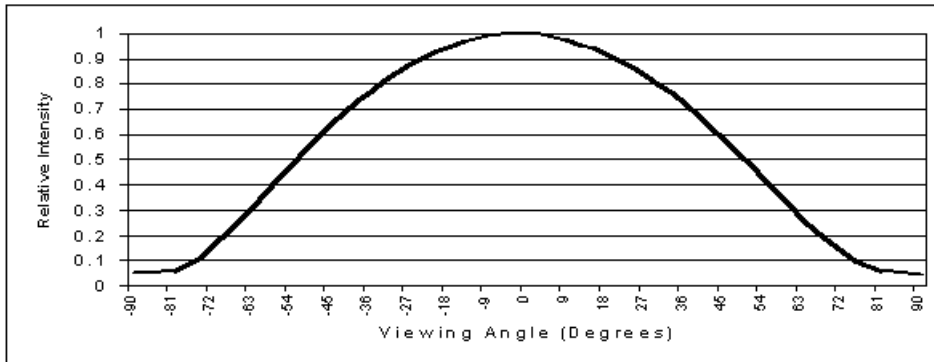

STANDARD TOLERANCE (UNLESS OTHERWISE SPECIFIED)		BIVAR [®] 4 THOMAS, IRVINE, CA. 92618 TEL: (949) 951-8808 FAX: (949) 951-3974	
DECIMALS	ANGULAR		
.X ±.1	X° ±1°	 TITLE: 1W-LED Module	
.XX ±.02			
.XXX ±.010		PART NO: LK-XXX-XXX-FC REVISION: A	
DESIGNED: Michael Chen	DATE: 05/04/05	CAGE CODE : 32559 SHEET # 2 OF 5	
CHECKED: T. Yin	DATE: 05/04/05	<small>CAD GENERATED DOCUMENT. DO NOT MEASURE DRAWING.</small>	

REV.	DESCRIPTION	DATE	APPROVED
	See Sheet #1 of 5.		

Nomenclature for Special Bin Groups:

LK- **XXX-XXX-FC**

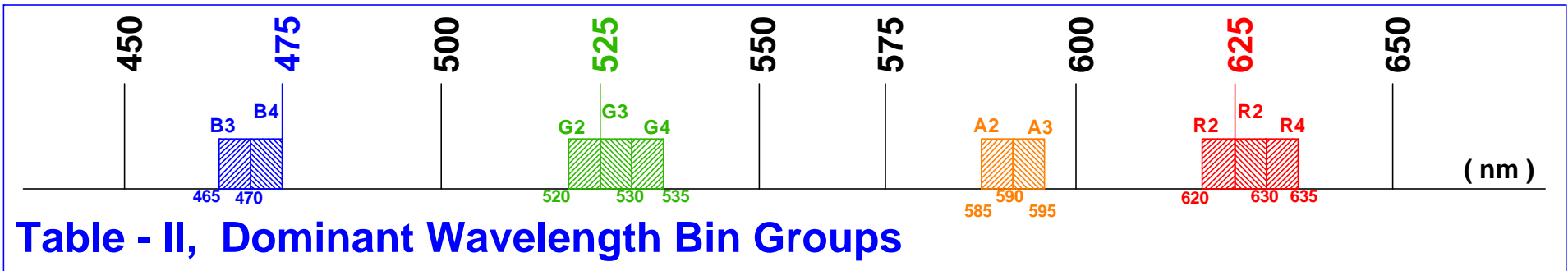
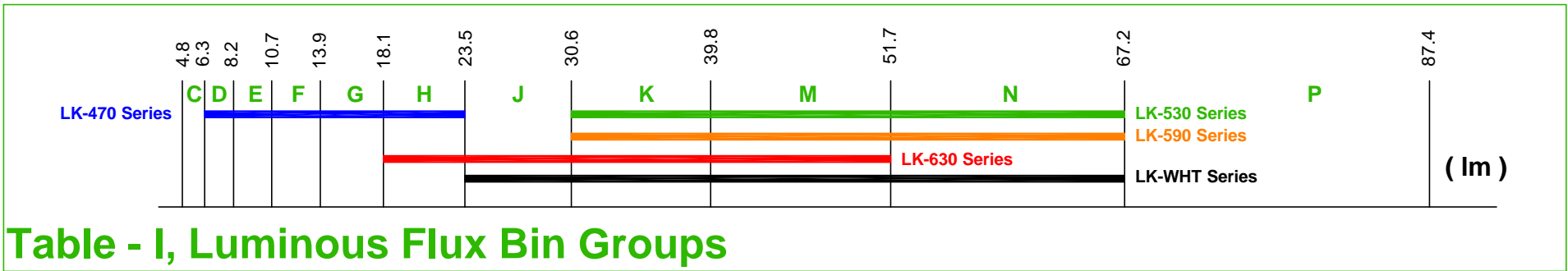
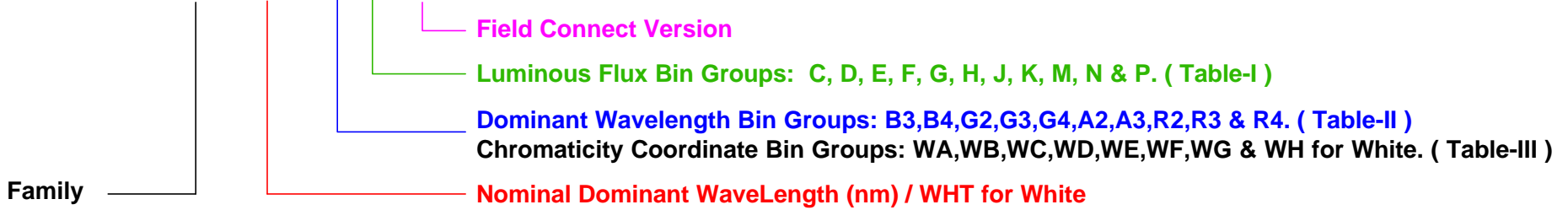

Chromaticity Region	WA				WB				WC				WD			
X Coordinate	.292	.295	.283	.279	.306	.308	.295	.292	.316	.317	.308	.306	.329	.329	.317	.316
Y Coordinate	.306	.297	.284	.291	.322	.311	.297	.306	.332	.319	.311	.322	.345	.330	.319	.332

Chromaticity Region	WE				WF				WG				WH			
X Coordinate	.301	.306	.292	.287	.314	.316	.306	.301	.329	.329	.316	.314	.348	.346	.329	.329
Y Coordinate	.342	.322	.306	.321	.355	.332	.322	.342	.369	.345	.332	.355	.384	.359	.345	.369

Table - III, Chromaticity Coordinate Bin Groups

STANDARD TOLERANCE (UNLESS OTHERWISE SPECIFIED)		 4 THOMAS, IRVINE, CA. 92618 TEL: (949) 951-8808 FAX: (949) 951-3974	
DECIMALS	ANGULAR		
.X ± .1	X° ± 1°		
.XX ± .02			TITLE: 1W-LED Module
.XXX ± .010			PART NO: LK-XXX-XXX-FC
DESIGNED: Michael Chen	DATE: 05/04/05	REVISION: A	
CHECKED: T. Yin	DATE: 05/04/05	CAGE CODE : 32559	SHEET # 3 OF 5
CAD GENERATED DOCUMENT. DO NOT MEASURE DRAWING.			

REV.	DESCRIPTION	DATE	APPROVED
	See Sheet #1 of 5.		

* Electrical Characteristics.

Blue / Green / White

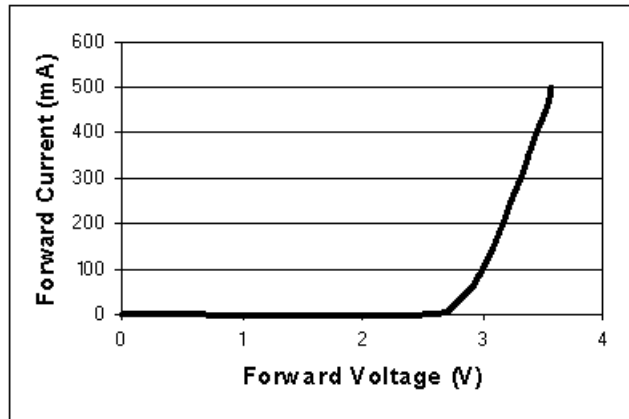

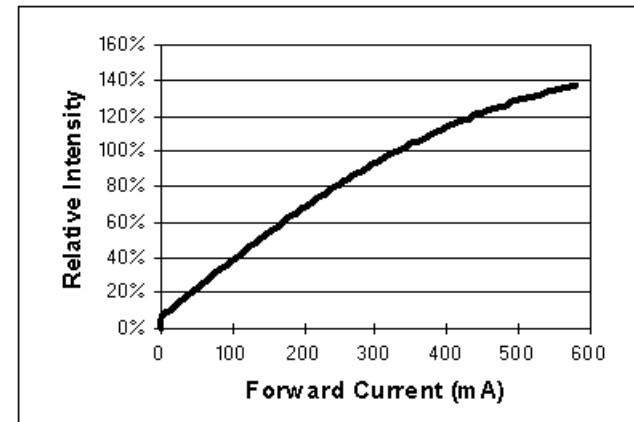
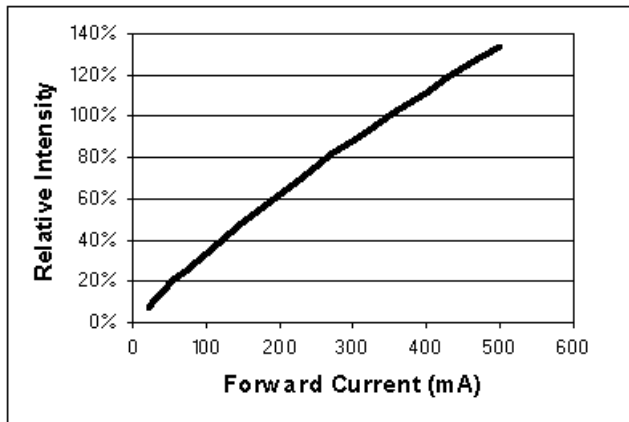
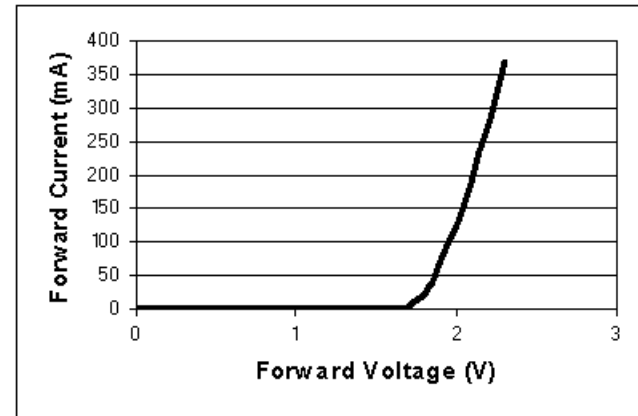

Amber / Red



Blue / Green / White

Amber / Red

** Optical Characteristics.

STANDARD TOLERANCE (UNLESS OTHERWISE SPECIFIED)		 4 THOMAS, IRVINE, CA. 92618 TEL: (949) 951-8808 FAX: (949) 951-3974	
DECIMALS	ANGULAR		
.X ± .1	X° ± 1°	TITLE: 1W-LED Module PART NO: LK-XXX-XXX-FC REVISION: A CAGE CODE : 32559 SHEET # 4 OF 5 <small>CAD GENERATED DOCUMENT. DO NOT MEASURE DRAWING.</small>	
.XX ± .02			
.XXX ± .010			
DESIGNED: Michael Chen	DATE: 05/04/05		
CHECKED: T. Yin	DATE: 05/04/05		

REV.	DESCRIPTION	DATE	APPROVED
	See Sheet #1 of 5.		

*** $R_{\theta JA}$ = Thermal resistance between the LED Junction point to ambient which is critical to optimize lamp life and optical characteristics.

$R_{\theta JA} = 80^{\circ}\text{C/W}$
 $R_{\theta JA} = 60^{\circ}\text{C/W}$
 $R_{\theta JA} = 50^{\circ}\text{C/W}$
 $R_{\theta JA} = 22^{\circ}\text{C/W}$

$R_{\theta JA} = 80^{\circ}\text{C/W}$
 $R_{\theta JA} = 60^{\circ}\text{C/W}$
 $R_{\theta JA} = 40^{\circ}\text{C/W}$
 $R_{\theta JA} = 20^{\circ}\text{C/W}$

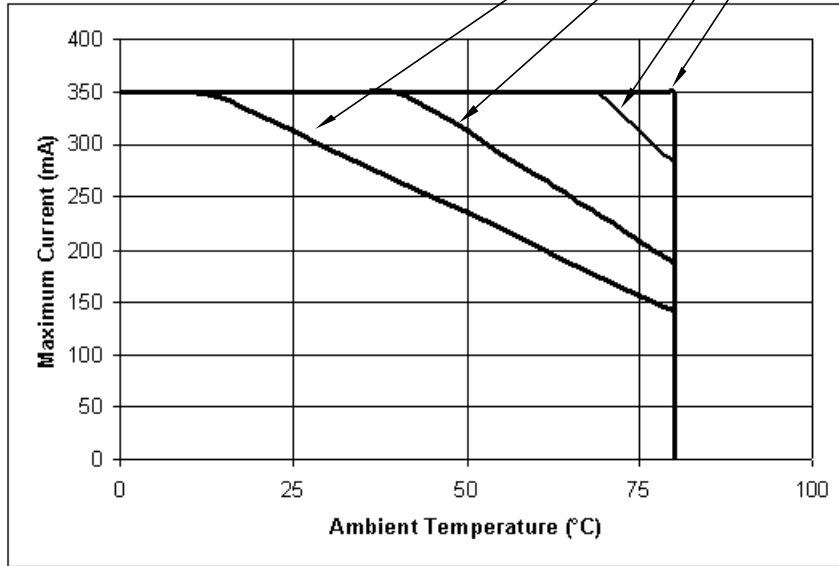

Blue / Green / White

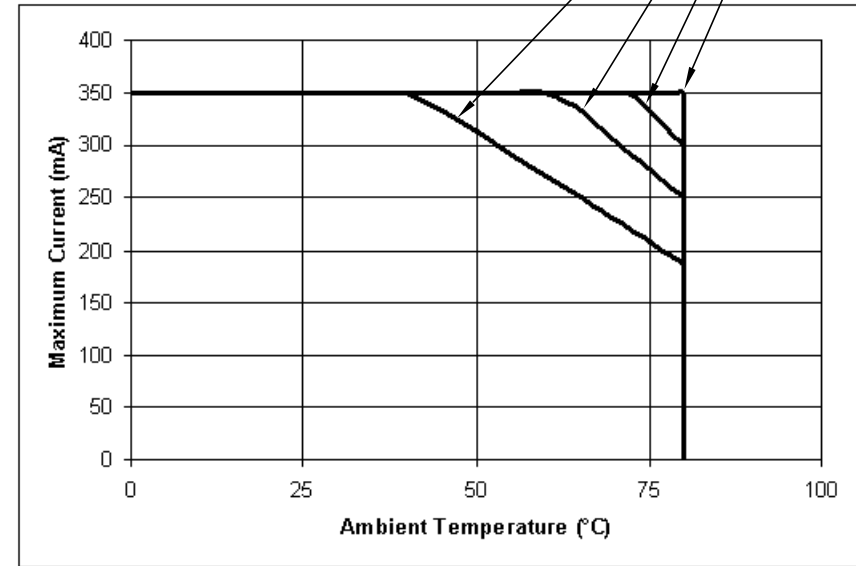

Amber / Red

Application Notes:

1. During handling process, mechanical stress on the lens surface should be minimized.
2. Never touch the optical surface with the hand or sharp objects since the surface can be damaged and affecting the optical performance of the LED.
3. When assemble modules in automation technology production, mechanical pressure on the surface of the optical lens must be prevented. This is assured by choosing a pick and place nozzle which is larger than the LED's top lens area.
4. After soldering, allow Modules to return to room temperature before subsequent handling. Premature handling of the module, especially around the lens, could result in damage to the product. Ultrasonic cleaning is not recommended.

STANDARD TOLERANCE (UNLESS OTHERWISE SPECIFIED)		BIVAR [®]	
DECIMALS	ANGULAR	4 THOMAS, IRVINE, CA. 92618	
.X ± .1	X° ± 1°	TEL: (949) 951-8808 FAX: (949) 951-3974	
.XX ± .02		TITLE: 1W-LED Module	
.XXX ± .010		PART NO: LK-XXX-XXX-FC	
DESIGNED: Michael Chen	DATE: 05/04/05	REVISION: A	
CHECKED: T. Yin	DATE: 05/04/05	CAGE CODE : 32559 SHEET # 5 OF 5	
CAD GENERATED DOCUMENT. DO NOT MEASURE DRAWING.			