

DATA SHEET

30 to 60 V, 145 V and
265 V ($T_S = 140\text{ °C}$)

**PTC thermistors for
overload protection**

Product specification
Supersedes data of 17th May 1999
File under BCcomponents, BC02

2000 Oct 13

PTC thermistors for overload protection

30 to 60 V, 145 V and
265 V ($T_S = 140\text{ °C}$)

FEATURES

- Different voltages to be chosen in function of the application
- Available in three mechanical versions: F
 - 2322 66. 4.... naked discs
 - 2322 66. 5.... leaded and coated
 - 2322 66. 6.... taped, on reel (to diameter 12.5 mm)
- Wide range of trip and non-trip currents: from 17 mA up to 3 A for the trip current
- Wide range of resistance: from 0.3 Ω up to 3 k Ω
- Small ratio between trip and non-trip currents ($I_t/I_{nt} = 1.5$ at 25 °C)
- High maximum inrush current
- Excellent long term behaviour, also in humidity
- Leaded parts withstand mechanical stresses and vibration
- UL approved PTCs are guaranteed to withstand severe test programmes including:
 - long-life cycle tests (over 5000 trip cycles)
 - long-life storage tests (3000 hours at 250 °C)
 - electrical cycle tests at low ambient temperatures (–40 °C or 0 °C)
 - damp-heat and water immersion tests
 - overvoltage tests at up to 200% of rated voltage.
- UL file E148885 according to XGPU2 standard UL1434.

MARKING

- Clear marking: the grey lacquered thermistors with a diameter of 8.5 to 20 mm are marked with BC, R_{25} value (example 4R6) on one side and I_{nt} , V_{max} on the other.

APPLICATIONS

- Telecommunications
- Automotive systems
- Industrial electronics
- Consumer electronics
- Electronic data processing.

DESCRIPTION

These directly heated thermistors have a positive temperature coefficient and are primarily intended for overload protection. They consist of a naked disc or with two tinned brass or copper clad steel leads and coated.

QUICK REFERENCE DATA

PARAMETER	VALUE	UNIT
Switch temperature; note 1	140	°C
Maximum voltage; note 2:		
2322 66. 4/5/6...1	30 to 60	V (DC)
2322 66. 4/5/6...2	145	V (RMS)
2322 66. 4/5/6...3	265	V (RMS)
Temperature range:		
2322 66. 4/5/6...1	–40 to +85	°C
2322 66. 4/5/6...2	0 to 70	°C
2322 66. 4/5/6...3	0 to 70	°C
Climatic category:		
66. 4/5/6...1	40/125/56	
66. 4/5/6...2/3	25/125/56	

Notes

1. 2322 660 4/5/6 ...3 types, have a 120 °C switch temperature.
2. Rated voltages are respectively:
 - 24 to 48 V (AC or DC)
 - 120 V (AC or DC)
 - 230 V (AC or DC).

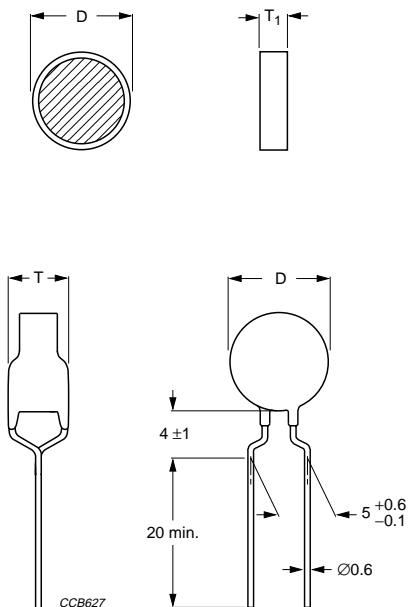
**PTC thermistors for
overload protection****30 to 60 V, 145 V and
265 V ($T_S = 140\text{ }^\circ\text{C}$)****MECHANICAL DATA**

Dimensions in mm.

For D see Table 1; for T_1 and T see Table 2.

Fig.1 Component outline for 2322 66. 4/5...1/2/3.

PTC thermistors for overload protection

30 to 60 V, 145 V and 265 V ($T_s = 140\text{ }^\circ\text{C}$)

Table 1 Device and tape dimensions, packaging and catalogue numbers

D MAX. (mm)	H ₁ MAX. (mm)	H ₃ MAX. (mm)	PACKAGING AND CATALOGUE NUMBERS 2322		
			NAKED (Fig.1)	LEADED BULK (Fig.1)	LEADED TAPED (Fig.25)
5	26	9.5	660 49491; 660 41311; 660 41811; 660 42711; 660 44792; 660 46592; 660 49392; 660 41112; 660 41312; 660 41193; 660 41593; 660 41993; 660 42893; 660 43993; 660 46393; 660 47693; 660 49593	660 59491; 660 51311; 660 51811; 660 52711; 660 54792; 660 56592; 660 59392; 660 51112; 660 51312; 660 51193; 660 51593; 660 51993; 660 52893; 660 53993; 660 56393; 660 57693; 660 59593	660 69491; 660 61311; 660 61811; 660 62711; 660 64792; 660 66592; 660 69392; 660 61112; 660 61312; 660 61193; 660 61593; 660 61993; 660 62893; 660 63993; 660 66393; 660 67693; 660 69593
7	28	11.5	661 43211; 661 44111; 661 41712; 661 42112; 661 41113; 661 41413	661 53211; 661 54111; 661 51712; 661 52112; 661 51113; 661 51413	661 63211; 661 64111; 661 61712; 661 62112; 661 61113; 661 61413
8.5	29.5	13.0	661 44711; 661 45411; 661 42512; 661 42712; 661 41713; 661 41913	661 54711; 661 55411; 661 52512; 661 52712; 661 51713; 661 51913	661 64711; 661 65411; 661 62512; 661 62712; 661 61713; 661 61913
10.5	31.5	15.0	662 46111; 662 47011; 662 43212; 662 43612; 662 42113; 662 42513	662 56111; 662 57011; 662 53212; 662 53612; 662 52113; 662 52513	662 66111; 662 67011; 662 63212; 662 63612; 662 62113; 662 62513
12.5	32.5	17.0	662 48311; 662 49211; 662 44112; 662 44512; 662 42813; 662 43213	662 58311; 662 59211; 662 54112; 662 54512; 662 52813; 662 53213	662 68311; 662 69211; 662 64112; 662 64512; 662 62813; 662 63213
16.5	–	–	663 41121; 663 41321; 663 46012; 663 47112; 663 44013; 663 44913	663 51121; 663 51321; 663 56012; 663 57112; 663 54013; 663 54913	–
20.5	–	–	664 41721; 664 42021; 664 48812; 664 41022; 664 45913; 664 47013	664 51721; 664 52021; 664 58812; 664 51022; 664 55913; 664 57013	–

Table 2 Thickness dimensions and catalogue numbers

T ₁ MAX. (mm)	T MAX. (mm)	CATALOGUE NUMBERS 2322
1.7	4.0	66. 4/5...1
2.8	5.0	66. 4/5...2
3.2	5.5	66. 4/5...3

**PTC thermistors for
overload protection**

30 to 60 V ($T_s = 140\text{ °C}$)

ELECTRICAL DATA AND ORDERING INFORMATION

Table 3 Electrical data and ordering information for **2322 66. 4/5/6...1**; max. voltage = 30 to 60 V (AC or DC); see note 1.
Preferred types in shaded cells.

$I_{nt}^{(2)}$ MAX. at 25 °C (mA)	$I_t^{(2)}$ MIN. at 25 °C (mA)	R_{25} $\pm 20\%$ (Ω)	V MAX. (V)	$I_t^{(4)}$ MAX. at 25 °C (mA)	I_{res} MAX. at V_{max} and 25 °C (mA)	DISSIP. FACTOR (mW/K)	TYPICAL $\varnothing D$ (mm)	CATALOGUE NUMBERS ⁽³⁾	
								BULK	TAPE ON REEL
94	145	50	60	800	22	6.9	4.5	2322 660 59491	2322 660 69491
130	195	25	60	1200	25	6.9	4.5	2322 660 51311	2322 660 61311
180	270	13	30	1700	45	6.9	4.5	2322 660 51811	2322 660 61811
270	405	6	30	2500	60	6.9	4.5	2322 660 52711	2322 660 62711
320	480	5	30	3500	62	7.8	6.5	2322 661 53211	2322 661 63211
410	615	3	30	4500	65	7.8	6.5	2322 661 54111	2322 661 64111
470	705	2.5	30	5000	70	8.8	8.0	2322 661 54711	2322 661 64711
540	810	1.9	30	6000	75	8.8	8.0	2322 661 55411	2322 661 65411
610	915	1.7	30	7000	80	9.9	10	2322 662 56111	2322 662 66111
700	1050	1.3	30	8000	90	9.9	10	2322 662 57011	2322 662 67011
830	1245	1.1	30	10000	100	11.5	12	2322 662 58311	2322 662 68311
920	1380	0.9	30	11000	105	11.5	12	2322 662 59211	2322 662 69211
1 170	1755	0.7	30	13500	140	14.5	16	2322 663 51121	–
1 390	2085	0.5	30	16000	170	14.5	16	2322 663 51321	–
1 770	2655	0.4	30	20000	200	18.7	20	2322 664 51721	–
2050	3075	0.3	30	23000	220	18.7	20	2322 664 52021	–

Notes

1. The thermistors are clamped at the seating plane.
2. For leadless types the values given for I_{nt} and I_t are only valid for thermistors mounted in accordance with "IEC 60738". Thermistor dissipation depends on mounting and can slightly affect the typical values.
3. For leadless types replace the 8th digit in the catalogue numbers by 4.
4. I_{max} is the maximum overload current that may flow through the PTC when it passes from the low ohmic to the high ohmic state; see Figs 2 and 3.

**PTC thermistors for
overload protection**
145 V (T_s = 140 °C)
Table 4 Electrical data and ordering information for **2322 66. 4/5/6...2**; max. voltage = 145 V (AC or DC); see note 1

I _{nt} ⁽²⁾ MAX. at 25 °C (mA)	I _t ⁽²⁾ MIN. at 25 °C (mA)	R ₂₅ ±25% (Ω)	I ⁽⁴⁾ MAX. at 25 °C (mA)	I _{res} MAX. at V _{max} and 25 °C (mA)	DISSIP. FACTOR (mW/K)	TYPICAL ØD (mm)	CATALOGUE NUMBERS ⁽³⁾	
							BULK	TAPE ON REEL
47	70	240	200	9	7.3	4.5	2322 660 54792	2322 660 64792
65	100	115	300	11	7.3	4.5	2322 660 56592	2322 660 66592
93	140	55	450	13	7.3	4.5	2322 660 59392	2322 660 69392
110	165	40	500	13	7.3	4.5	2322 660 51112	2322 660 61112
130	195	28	600	13	7.3	4.5	2322 660 51312	2322 660 61312
170	255	19	1000	15	8.3	6.5	2322 661 51712	2322 661 61712
210	315	12	1400	15	8.3	6.5	2322 661 52112	2322 661 62112
250	375	9.4	2000	16.5	9	8.0	2322 661 52512	2322 661 62512
270	405	8	2200	16.5	9	8.0	2322 661 52712	2322 661 62712
320	480	6.7	3000	19	10.5	10	2322 662 53212	2322 662 63212
360	540	5.3	3500	19	10.5	10	2322 662 53612	2322 662 63612
410	615	4.6	4500	22.5	11.7	12	2322 662 54112	2322 662 64112
450	675	3.8	5000	22.5	11.7	12	2322 662 54512	2322 662 64512
600	900	2.9	7200	28.5	15.5	16	2322 663 56012	–
710	1065	2.1	8500	28.5	15.5	16	2322 663 57112	–
880	1320	1.7	11000	37.5	19.8	20	2322 664 58812	–
1000	1500	1.3	13000	37.5	19.8	20	2322 664 51022	–

Notes

1. The thermistors are clamped at the seating plane.
2. For leadless types the values given for I_{nt} and I_t are only valid for thermistors mounted in accordance with "IEC 60738". Thermistor dissipation depends on mounting and can slightly affect the typical values.
3. For leadless types replace the 8th digit in the catalogue numbers by 4.
4. I_{max} is the maximum overload current that may flow through the PTC when it passes from the low ohmic to the high ohmic state; see Figs 2 and 3.

**PTC thermistors for
overload protection**

265 V (T_s = 140 °C)

Table 5 Electrical data and ordering information for **2322 66. 4/5/6...3**; max. voltage = 265 V (AC or DC); see note 1.
Preferred types in shaded cells.

I _{nt} ⁽²⁾ MAX. at 25 °C (mA)	I _t ⁽²⁾ MIN. at 25 °C (mA)	R ₂₅ ±25% (Ω)	I ⁽⁴⁾ MAX. at 25 °C (mA)	I _{res} MAX. at V _{max} and 25 °C (mA)	DISSIP. FACTOR (mW/K)	TYPICAL ØD (mm)	CATALOGUE NUMBERS ⁽³⁾	
							BULK	TAPE ON REEL
11	17	3000	80	6.5	7.3	4.5	2322 660 51193	2322 660 61193
15	23	1900	110	6.5	7.3	4.5	2322 660 51593	2322 660 61593
19	29	1200	140	6.5	7.3	4.5	2322 660 51993	2322 660 61993
28	42	500	200	6.8	7.3	4.5	2322 660 52893	2322 660 62893
39	59	260	300	6.8	7.3	4.5	2322 660 53993	2322 660 63993
63	95	120	450	7	7.3	4.5	2322 660 56393	2322 660 66393
76	115	85	550	7	7.3	4.5	2322 660 57693	2322 660 67693
95	143	56	600	7	7.3	4.5	2322 660 59593	2322 660 69593
110	165	48	650	7.5	8.3	6.5	2322 661 51113	2322 661 61113
140	210	29	800	8	8.3	6.5	2322 661 51413	2322 661 61413
170	255	22	900	9	9	8.0	2322 661 51713	2322 661 61713
190	285	18	1000	9.5	9	8.0	2322 661 51913	2322 661 61913
210	315	17	1300	10	10.5	10	2322 662 52113	2322 662 62113
250	375	12	1500	11	10.5	10	2322 662 52513	2322 662 62513
280	420	11	1800	12	11.7	12	2322 662 52813	2322 662 62813
320	480	8.4	2200	13	11.7	12	2322 662 53213	2322 662 63213
400	600	6.6	3000	15	15.5	16	2322 663 54013	–
490	735	4.4	3500	16	15.5	16	2322 663 54913	–
590	855	4	4500	19.5	19.8	20	2322 664 55913	–
700	1050	2.8	5500	21	19.8	20	2322 664 57013	–

Notes

1. The thermistors are clamped at the seating plane.
2. For leadless types the values given for I_{nt} and I_t are only valid for thermistors mounted in accordance with "IEC 60738". Thermistor dissipation depends on mounting and can slightly affect the typical values.
3. For leadless types replace the 8th digit in the catalogue numbers by 4.
4. I_{max} is the maximum overload current that may flow through the PTC when it passes from the low ohmic to the high ohmic state; see Figs 2 and 3.

**PTC thermistors for
overload protection**

**30 to 60 V, 145 V and
265 V ($T_S = 140\text{ }^\circ\text{C}$)**

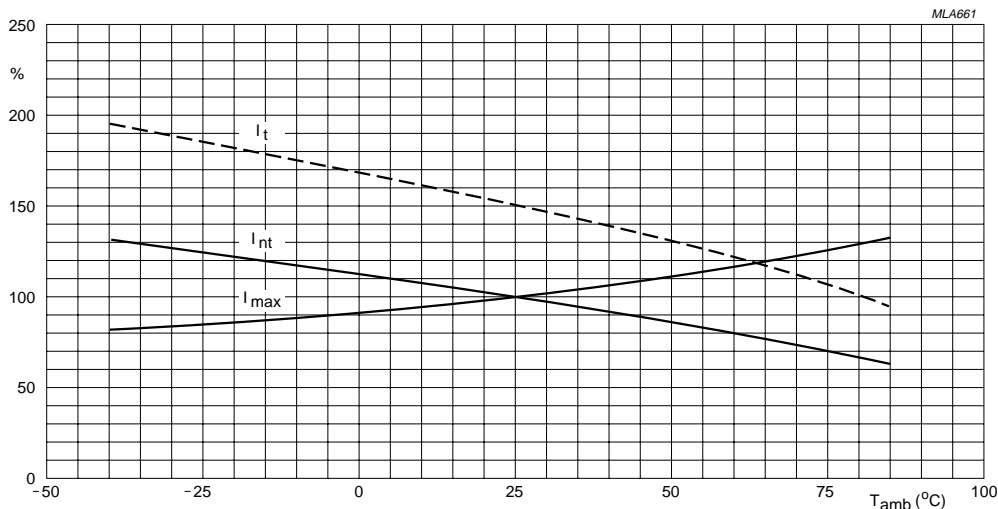

Fig.2 Current deviation as a function of the ambient temperature.

PTC thermistors for overload protection

30 to 60 V, 145 V and
265 V ($T_s = 140\text{ }^\circ\text{C}$)

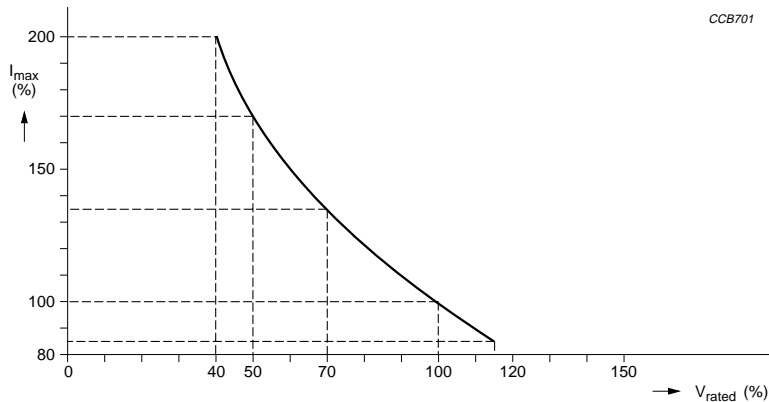

Fig.3 I_{max} as a function of voltage.

I_{max} as stated in Tables 3, 4 and 5 is the maximum overload current that may flow through the PTC when passing from the low ohmic to high ohmic state at rated voltage.

When other voltages are present after tripping, the I_{max} value can be derived from the above Fig.3. Voltages below V_{rated} will allow higher overload currents to pass the PTC.

Example

What maximum overload current is allowed for a thermistor type 2322 662 52513 at $0\text{ }^\circ\text{C}$ and a maximum voltage after tripping of 180 V_{RMS} :

I_{max} at 230 V and $25\text{ }^\circ\text{C} = 1.5\text{ A}_{RMS}$: see Table 5.

I_{max} at 180 V and $25\text{ }^\circ\text{C} = 1.85\text{ A}_{RMS}$ ($180\text{ V}_{RMS} = 78\%$ of 230 V_{RMS} gives 123% of I_{max}).

At $0\text{ }^\circ\text{C}$ this gives 1.68 A_{RMS} maximum overload current; see Fig.2.

PTC thermistors for overload protection

30 to 60 V ($T_s = 140\text{ }^\circ\text{C}$)

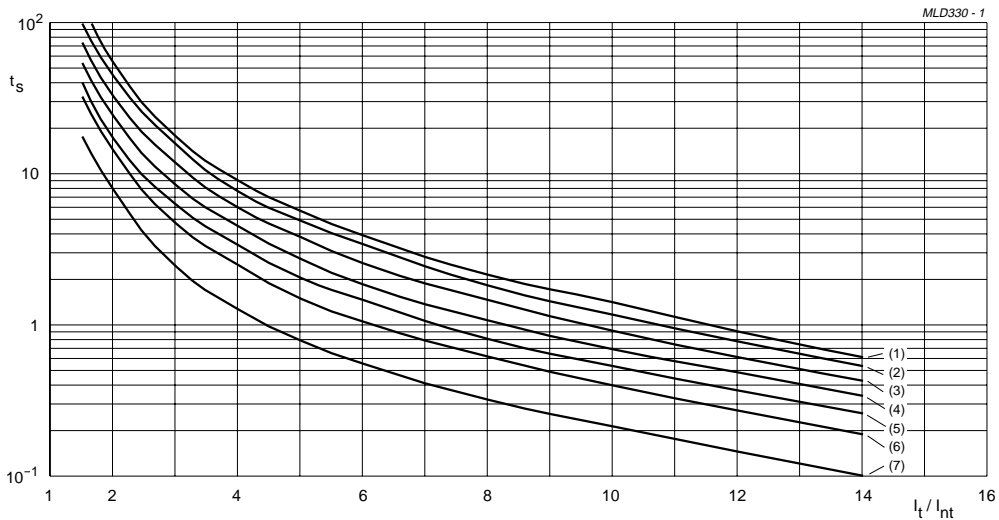

Curve 1: typical $\varnothing D = 20\text{ mm}$.

Curve 2: typical $\varnothing D = 16\text{ mm}$.

Curve 3: typical $\varnothing D = 12.0\text{ mm}$.

Curve 4: typical $\varnothing D = 10.0\text{ mm}$.

Curve 5: typical $\varnothing D = 8.0\text{ mm}$.

Curve 6: typical $\varnothing D = 6.5\text{ mm}$.

Curve 7: typical $\varnothing D = 4.5\text{ mm}$.

Measured in accordance with "IEC 60738".

For an example, see "Trip-time or switching time (t_s)".

Fig.4 Typical trip-time as a function of trip current ratio for 30 to 60 volt types.

Trip-time or switching time (t_s)

To check the trip-time for a specific PTC, refer to Table 3, 4 or 5 for the value I_{nt} . Divide the overload or trip current by this I_{nt} and you realize the factor I_t/I_{nt} . This rule is valid for any ambient temperature between 0 and 70 °C. Adapt the correct non-trip current with the appropriate curve in Fig.2. The relationship between the I_t/I_{nt} factor and the switching time is a function of the PTC diameter; see Figs 4 and 5.

EXAMPLE

What will be the trip-time at $I_{ol} = 3\text{ A}$ and $T_{amb} = 0\text{ }^\circ\text{C}$ of a thermistor type 2322 661 54711; $2.5\ \Omega$; $\varnothing D = 8.0\text{ mm}$:

I_{nt} from Table 3: 470 mA at 25 °C

I_{nt} : $470 \times 1.12 = 526\text{ mA}$ (0 °C).

Overload current = 3 A; factor I_t/I_{nt} : $\sqrt[3]{0.526} = 5.70$. In Fig.4 at the 8.0 mm line and $I_t/I_{nt} = 5.70$, the typical trip-time is 1.7 s.

**PTC thermistors for
overload protection**

**30 to 60 V, 145 V and
265 V ($T_s = 140\text{ }^\circ\text{C}$)**

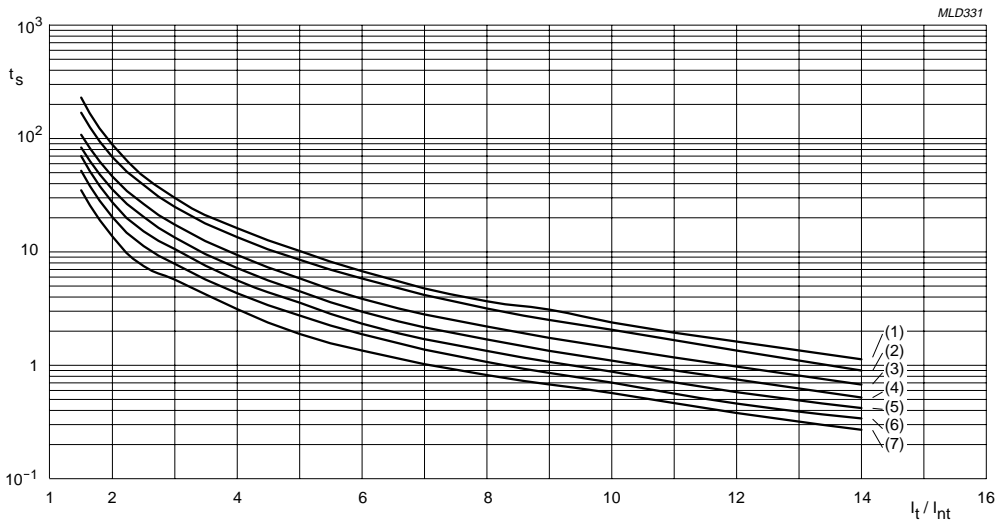

Curve 1: typical $\varnothing D = 20.0$ mm.

Curve 2: typical $\varnothing D = 16.0$ mm.

Curve 3: typical $\varnothing D = 12.0$ mm.

Curve 4: typical $\varnothing D = 10.0$ mm.

Curve 5: typical $\varnothing D = 8.0$ mm.

Curve 6: typical $\varnothing D = 6.5$ mm.

Curve 7: typical $\varnothing D = 4.5$ mm.

Measured in accordance with "IEC 60738".

For an example, see "Trip-time or switching time (t_s)".

Fig.5 Typical trip-time as a function of trip current ratio for 145 and 265 volt types.

PTC thermistors for overload protection

30 V and 60 V ($T_s = 140\text{ }^\circ\text{C}$)

Typical R/T characteristics

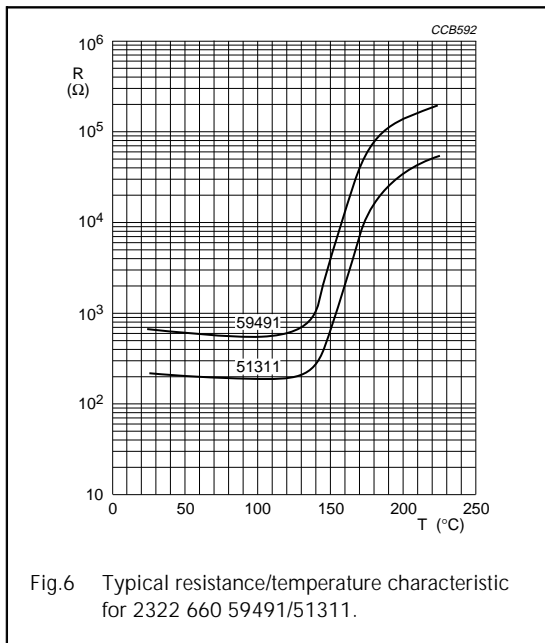

Fig.6 Typical resistance/temperature characteristic for 2322 660 59491/51311.

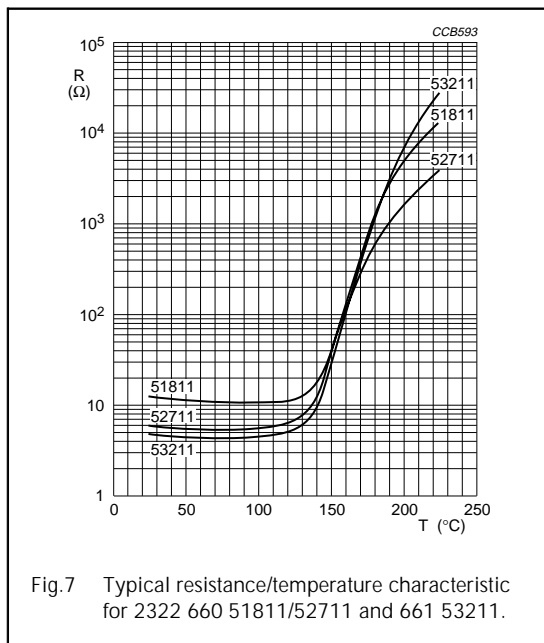

Fig.7 Typical resistance/temperature characteristic for 2322 660 51811/52711 and 661 53211.

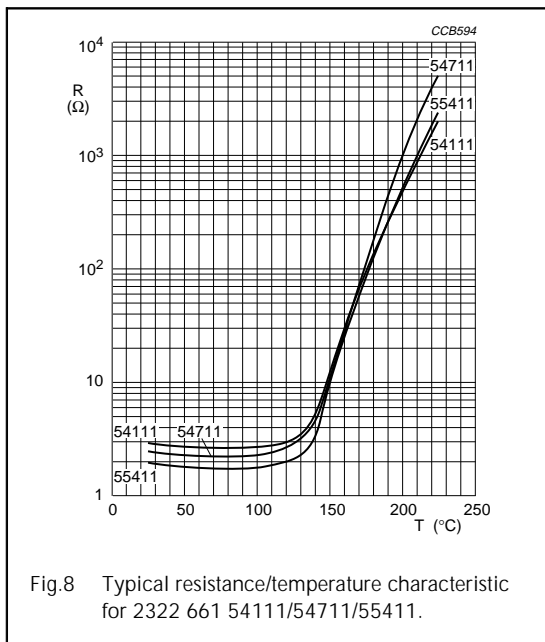

Fig.8 Typical resistance/temperature characteristic for 2322 661 54111/54711/55411.

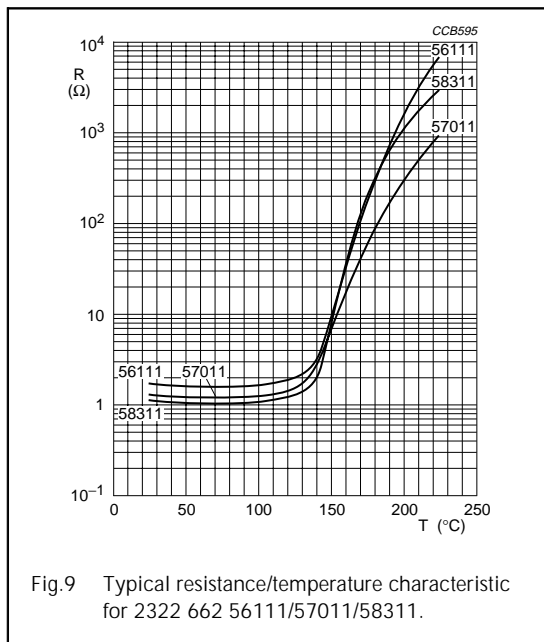
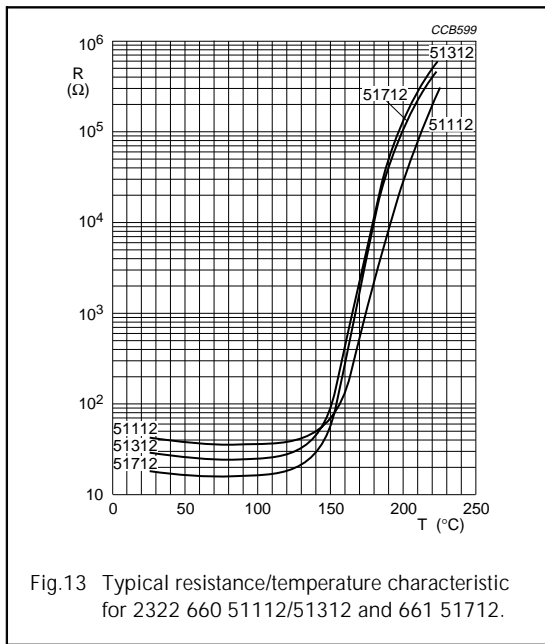
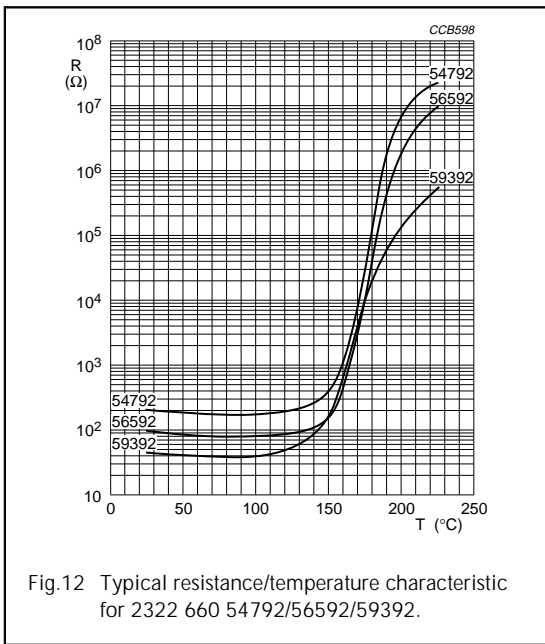
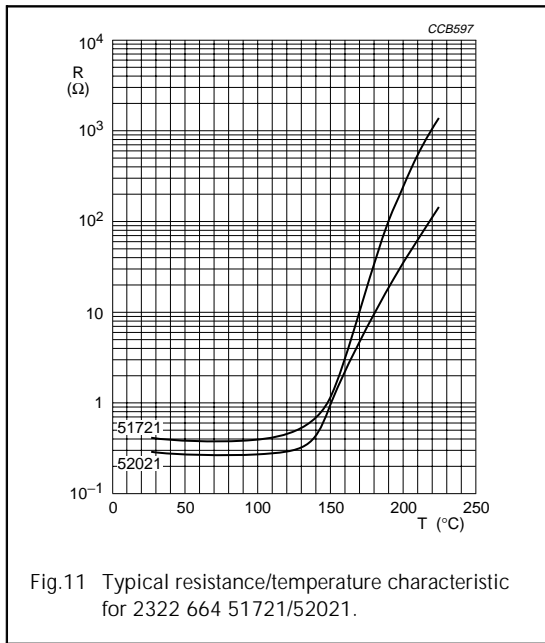
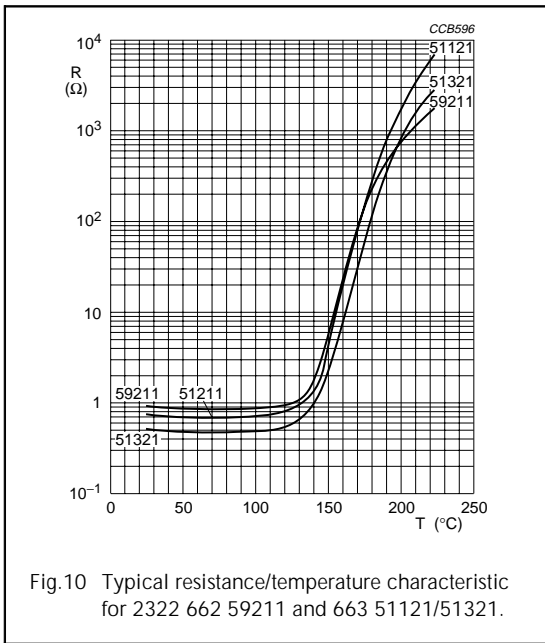

Fig.9 Typical resistance/temperature characteristic for 2322 662 56111/57011/58311.

PTC thermistors for overload protection

30 V and 145 V ($T_s = 140\text{ }^\circ\text{C}$)



PTC thermistors for overload protection

145 V ($T_s = 140\text{ }^\circ\text{C}$)

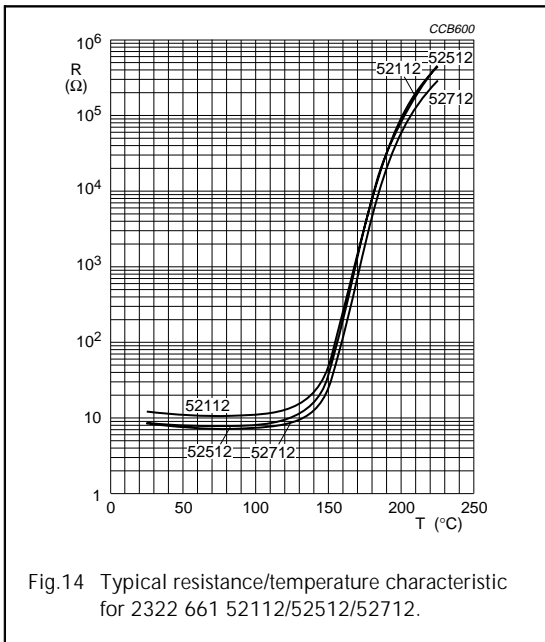

Fig.14 Typical resistance/temperature characteristic for 2322 661 52112/52512/52712.

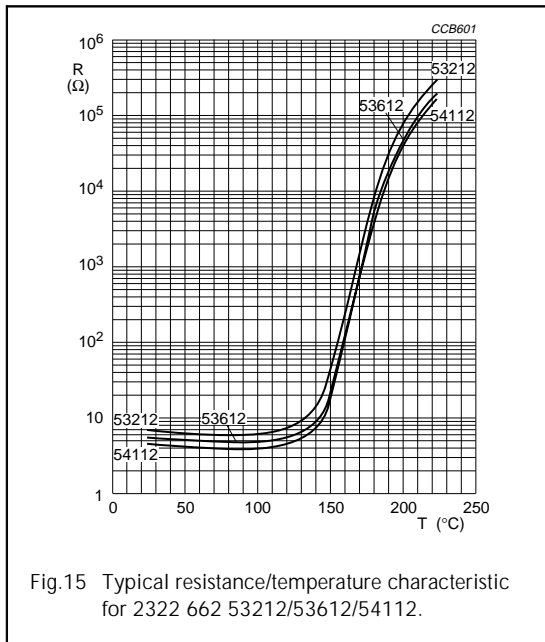

Fig.15 Typical resistance/temperature characteristic for 2322 662 53212/53612/54112.

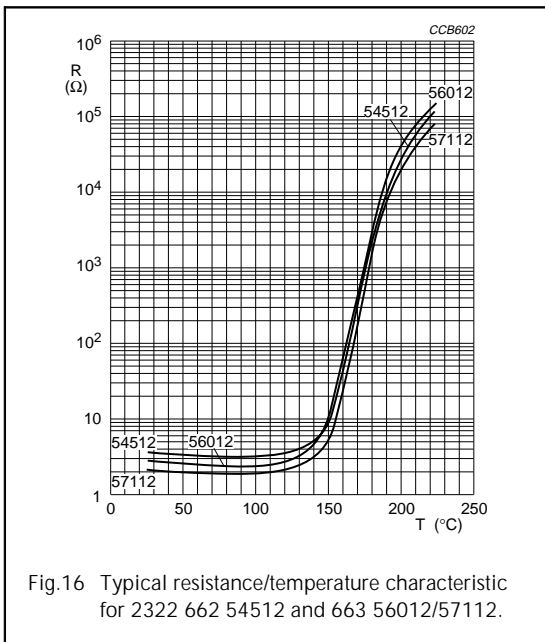

Fig.16 Typical resistance/temperature characteristic for 2322 662 54512 and 663 56012/57112.

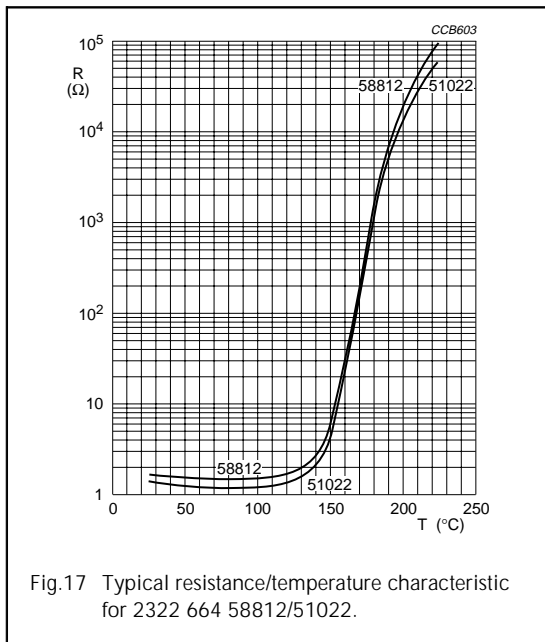
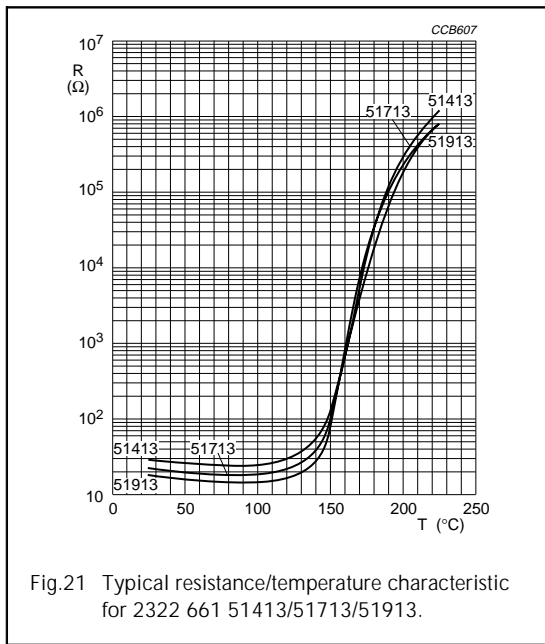
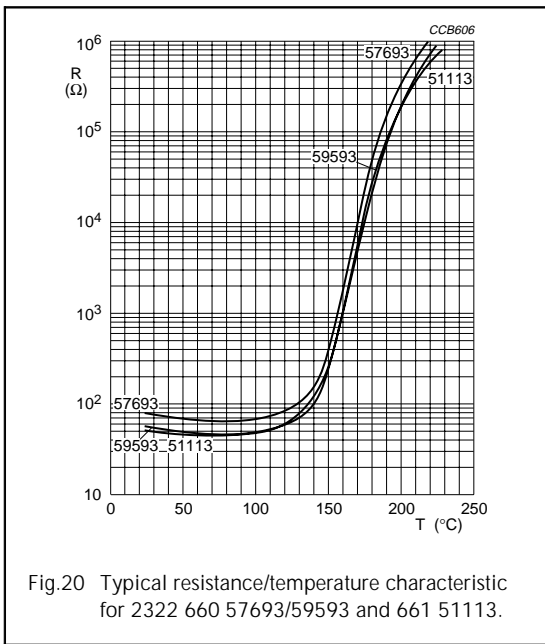
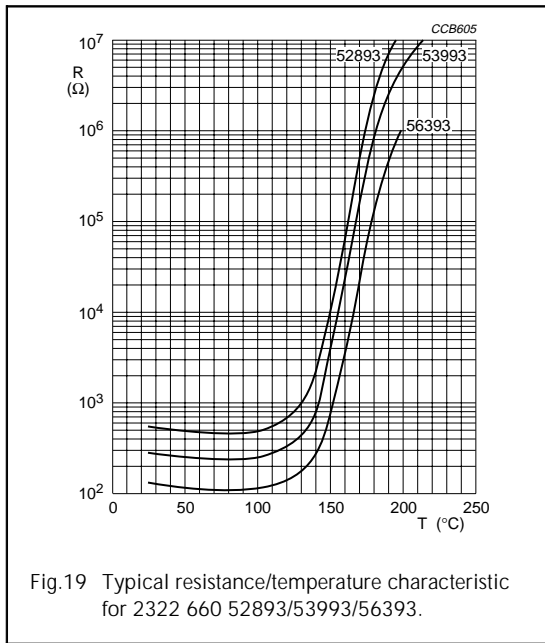
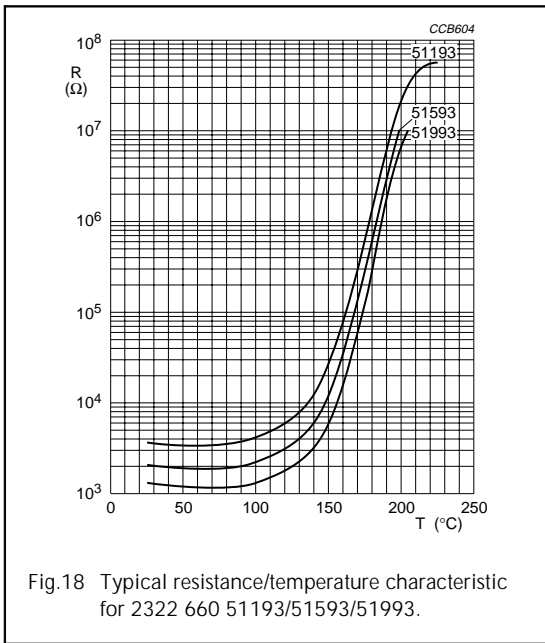

Fig.17 Typical resistance/temperature characteristic for 2322 664 58812/51022.

PTC thermistors for overload protection

265 V ($T_s = 140\text{ }^\circ\text{C}$)



PTC thermistors for overload protection

265 V ($T_s = 140\text{ }^\circ\text{C}$)

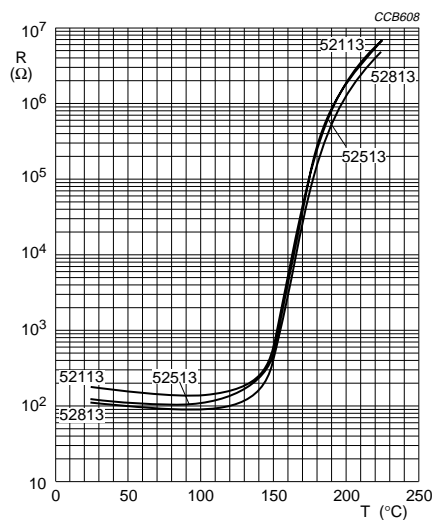

Fig.22 Typical resistance/temperature characteristic for 2322 662 52113/52513/52813.

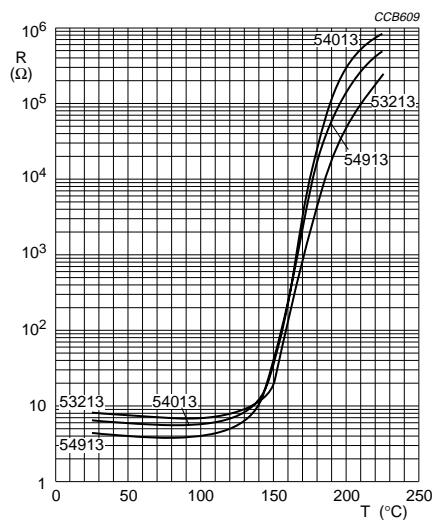

Fig.23 Typical resistance/temperature characteristic for 2322 662 53213 and 663 54013/54913.

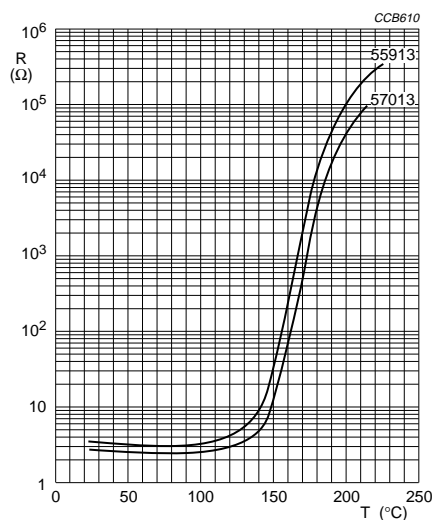

Fig.24 Typical resistance/temperature characteristic for 2322 664 55913/57013.

PTC thermistors for overload protection

30 to 60 V, 145 V and 265 V ($T_S = 140\text{ }^\circ\text{C}$)

PACKAGING

Tape and reel specifications

All tape and reel specifications are in accordance with "IEC 60286-3". Basic dimensions are given in Figs 25 and 26, and Tables 6 and 7.

Tape dimensions

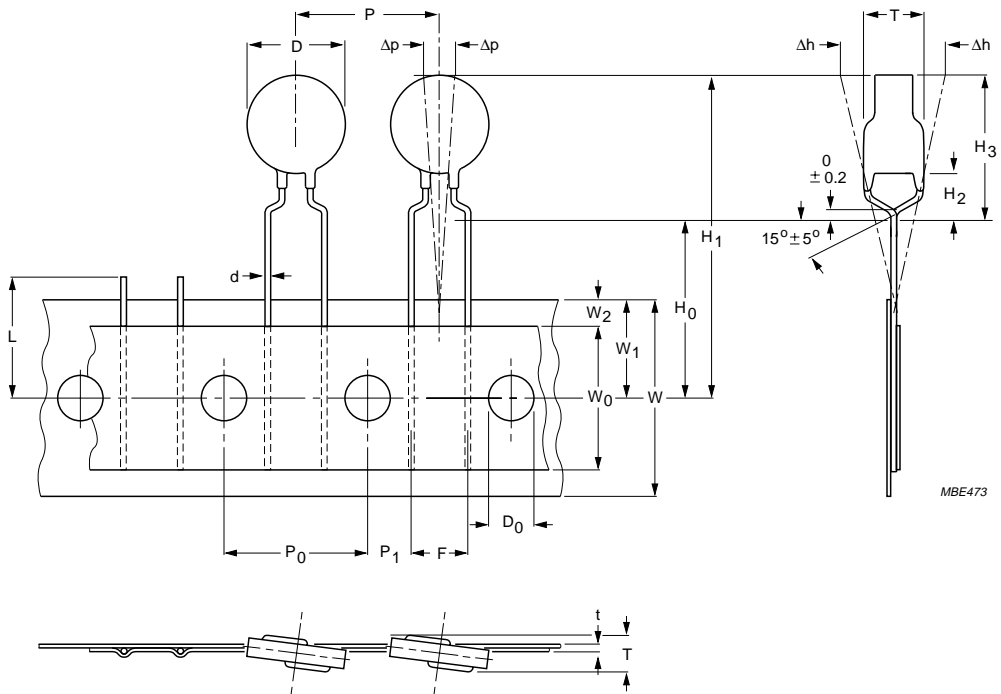

Dimensions in mm.
For dimensions, see Table 6.

Fig.25 Thermistors with $\text{Ø}D \leq 12\text{ mm}$ on tape for 2322 66. 6...1/2/3.

PTC thermistors for overload protection

30 to 60 V, 145 V and 265 V ($T_S = 140\text{ °C}$)

Table 6 Tape and other device dimensions; see Figs 1 and 25

SYMBOL	PARAMETER	DIMENSIONS (mm)	TOLERANCE	REMARKS
D	body diameter	see Table 1	± 0.5	
T	total maximum thickness	see Table 2		
d	lead diameter	0.6	$\pm 10\%$	
P	pitch between thermistors: $\varnothing < 12\text{ mm}$ $\varnothing \geq 12\text{ mm}$	12.7 25.4	± 1 ± 2	
P ₀	feed hole pitch	12.7	± 0.3	cumulative pitch error $\pm 1\text{ mm}/20\text{ pitches}$
P ₁	feed hole centre to lead centre	3.81	± 0.7	guaranteed between component and tape
Δh	component alignment	0	± 1.3	
F	lead to lead distance	5	+0.6 to -0.1	guaranteed between component and tape
Δh	component alignment	0	± 2	
W	tape width	18	+1 to -0.5	
W ₀	hold down tape width	≥ 12.3	-	
W ₁	hole position	9	± 0.5	
W ₂	hold down tape position	≤ 3.0	-	
H ₁	component height	see Table 1		
H ₂	component body to seating plane	4	± 1	
H ₃	component top to seating plane	see Table 1		
H ₀	lead-wire clinch height	16	± 0.5	
D ₀	feed hole diameter	4	± 0.2	
t	total tape thickness	≤ 0.9	-	with cardboard tape $0.5 \pm 0.1\text{ mm}$
L	length of snipped lead	≤ 11	-	

Characteristics concerning taped thermistors

PARAMETER	VALUE
Minimum pull out force of the component	5 N
Minimum pull off force of adhesive tape	6 N
Minimum tearing force tape	15 N
Maximum pull off force tape-reel	5 N
Storage conditions	
Storage temperature range	-25 to +40 °C
Maximum relative humidity	80%

**PTC thermistors for
overload protection**

**30 to 60 V, 145 V and
265 V ($T_s = 140\text{ }^\circ\text{C}$)**

Reel specifications

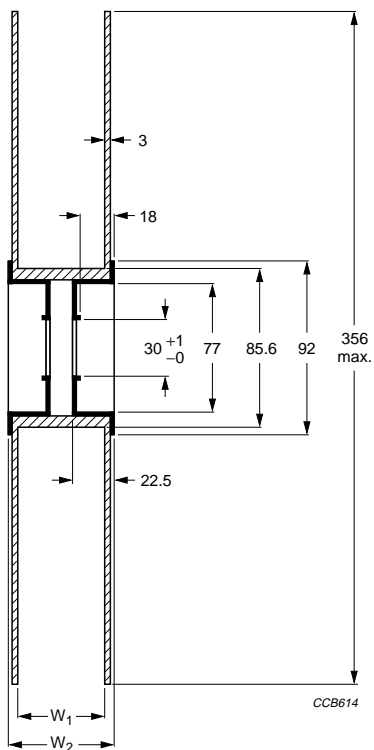

Dimensions in mm.
For W_1 and W_2 , see Table 7.

Fig.26 Dimensions of the reel for 2322 66. 6...1/2/3.

Table 7 Reel dimensions; see Fig.26

DIAMETER \varnothing (mm)	W_1 (mm)	W_2 MAX. (mm)
<12	42 ± 1	56
12	46 ± 1	60

PTC thermistors for overload protection

30 to 60 V, 145 V and 265 V ($T_S = 140\text{ °C}$)

PACKAGING INFORMATION

PACKAGING		CATALOGUE NUMBERS	
SPQ	PQ	FIRST 7 DIGITS	LAST 5 DIGITS
5000	20000	2322 660	4...1
3000	12000		4...2 and 3
500	10000		5...1, 2 and 3
3000	3000		6...1, 2 and 3
6000	6000	2322 661	4...1
3000	3000		4...2
3000	3000		4...3
250	5000		5...1, 2 and 3
3000	3000	2322 662	6...1, 2 and 3
5500	5500		4...1
3000	3000		4...2 and 3
250	5000		56111; 57011
3000	3000		66111; 67011
250	5000		58311; 59211
1500	1500		68311; 69211
200	4000		53212; 53612
3000	3000		63212; 63612
200	4000		54112; 54512
1500	1500		64112; 64512
200	4000		52113; 52513
3000	3000		62113; 62513
200	4000		52813; 53213
1500	1500	62813; 63213	
400	1600	2322 663	4...1, 2 and 3
200	4000		5...1
100	2000		5...2 and 3
400	1600	2322 664	4...1, 2 and 3
100	2000		5...1 and 2
50	1000		5...3

PTC thermistors for overload protection

30 to 60 V, 145 V and 265 V ($T_s = 140\text{ °C}$)

TESTS AND REQUIREMENTS

Clause numbers of tests and performance requirements refer to the CECC 44000 standard.

Inspection levels are selected from "IEC 60410". Tables with requirements for lot-by-lot and periodic tests.

In these tables:

D = Destructive

ND = Non-destructive.

Acceptable quality level

CLAUSE NUMBER	TEST	D OR ND	CONDITIONS	PERFORMANCE
Group A inspection (lot-by-lot)				
SUB-GROUP A1		ND		
4.3.1	visual examination			no defect likely to impair function
4.3.2	marking			
4.3.3	dimensions (gauging)			as specified
SUB-GROUP A2		ND		
4.4	zero power resistance		temperature: 25 °C	as specified
4.23	tripping current		measured at 25 °C	as specified
4.24	non-tripping current		measured at 25 °C	as specified
4.25	residual current at V_{max}		measured at 25 °C	as specified
Group B inspection (lot-by-lot)				
SUB-GROUP B1		D		
4.13.1	soldering, solderability		solder bath method: 235 ±5 °C	the leads shall be evenly tinned
Group C inspection (periodic)				
SUB-GROUP C1		D		
4.22.1	endurance (cycling)		duration: 10 cycles temperature: 25 °C voltage: as specified I_{max} : see Tables 3, 4, 5 and Fig.2 cycle: 1 minute on and 9 minutes off visual examination zero power resistance at 25 °C	as in 4.20.1.8 $\Delta R/R: \leq \pm 10\%$
			duration: 10 cycles temperature for: 30 and 60 V; -40 °C 145 and 265 V; 0 °C voltage: as specified I_{max} : see Tables 3, 4, 5 and Fig.2 cycle: 1 minute on and 9 minutes off visual examination zero power resistance at 25 °C	as in 4.20.1.8 $\Delta R/R: \leq \pm 10\%$

PTC thermistors for overload protection

30 to 60 V, 145 V and 265 V ($T_S = 140\text{ °C}$)

CLAUSE NUMBER	TEST	D OR ND	CONDITIONS	PERFORMANCE
SUB-GROUP C2		D		
4.12	robustness of terminations		half of the sample visual examination zero power resistance at 25 °C	as in 4.12.4; note 1 $\Delta R/R: \leq \pm 10\%$
4.13.2	resistance to soldering heat		test Tb of "IEC 60068-2-20A" visual examination zero power resistance at 25 °C	as in 4.13.2.3 $\Delta R/R: \leq \pm 10\%$
4.14	rapid change of temperature		other half of the sample T_A : lower category temperature: -40 °C T_B : upper category temperature: +125 °C number of cycles: 5 visual examination zero power resistance at 25 °C	as in 4.14.4 $\Delta R/R: \leq \pm 10\%$
SUB-GROUP C3		D		
4.20.3	endurance at maximum rated temperature and maximum rated voltage		duration: 24 hours examination after 24 hours visual examination zero power resistance at 25 °C	as in 4.20.3.10 $\Delta R/R: \leq \pm 10\%$
SUB-GROUP C4		D		
4.19	damp heat, steady state		visual examination zero power resistance at 25 °C	as in 4.19.5 $\Delta R/R: \leq \pm 10\%$

Note

1. Leads should neither come loose or break.