

TOSHIBA Bi-CMOS INTEGRATED CIRCUIT SILICON MONOLITHIC

T B 1 2 3 1 A N

PAL / NTSC 1CHIP (IF + VCD PROCESSOR) IC

TB1231AN is the IF & Video processing IC for PAL/NTSC color TV system. This IC demodulates PAL/NTSC PIF, SIF and composite video signal to R/G/B primary colors and Audio signals. This IC can constitute Multi-Color System by combined with TA1275Z (SECAM Processor).

TB1231AN has the analog R/G/B interface, therefore it is easy to make up PIP system by using this IC.

Because of the built-in video and audio switch, TB1231AN can deal with an external channel without extra switch.

TB1231AN has an I²C BUS interface. Various controls (Brightness, Color etc.) can be done via two bus lines.

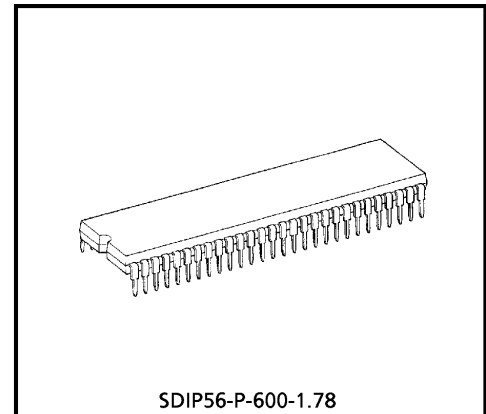

Weight : 5.55g (Typ.)

961001EBA1

- TOSHIBA is continually working to improve the quality and the reliability of its products. Nevertheless, semiconductor devices in general can malfunction or fail due to their inherent electrical sensitivity and vulnerability to physical stress. It is the responsibility of the buyer, when utilizing TOSHIBA products, to observe standards of safety, and to avoid situations in which a malfunction or failure of a TOSHIBA product could cause loss of human life, bodily injury or damage to property. In developing your designs, please ensure that TOSHIBA products are used within specified operating ranges as set forth in the most recent products specifications. Also, please keep in mind the precautions and conditions set forth in the TOSHIBA Semiconductor Reliability Handbook.
- The products described in this document are subject to foreign exchange and foreign trade control laws.
- The information contained herein is presented only as a guide for the applications of our products. No responsibility is assumed by TOSHIBA CORPORATION for any infringements of intellectual property or other rights of the third parties which may result from its use. No license is granted by implication or otherwise under any intellectual property or other rights of TOSHIBA CORPORATION or others.
- The information contained herein is subject to change without notice.

FEATURES

IF stage

- Intercarrier Input
- Double Time Constant IF AGC
- Bus Controlled RF AGC
- Bus Controlled PIF VCO
- L-SECAM Demodulation
- PLL SIF Demodulation (For 4.5~6.5MHz multi-SIF, Thank coil-less)

Video stage

- Built-in Video Switch (2 Inputs / 1 Output)
- Built-in Chroma Trap
- Built-in Y Delay Line
- Black Expansion
- DL Type Sharpness Control

Chroma stage

- 1 X'tal for Multi-System (3.58MHz / 4.43MHz / M-PAL / N-PAL)
- Built-in 1H DL
- Built-in BPF / TOF
- SECAM R-Y, B-Y Input
- Automatic Color System Detection
- Fsc Continuous Wave Output

Text stage

- Fast Blanking
- Analog R / G / B Interface
- Cut-Off / Drive Adjustment
- ABCL

Deflection stage

- Resonator less H-VCO
- Dual Horizontal AFC
- Horizontal Phase Control
- Vertical Phase & Amplitude Control
- H / V Lock Detection
- Sand Castle Pulse Output (HD + VD + Gate Pulse)
- No Vertical Output Mode

Audio Stage

- Built-in Audio Switch (2 Inputs / 1 Output)
- Built-in Audio Attenuator

BLOCK DIAGRAM

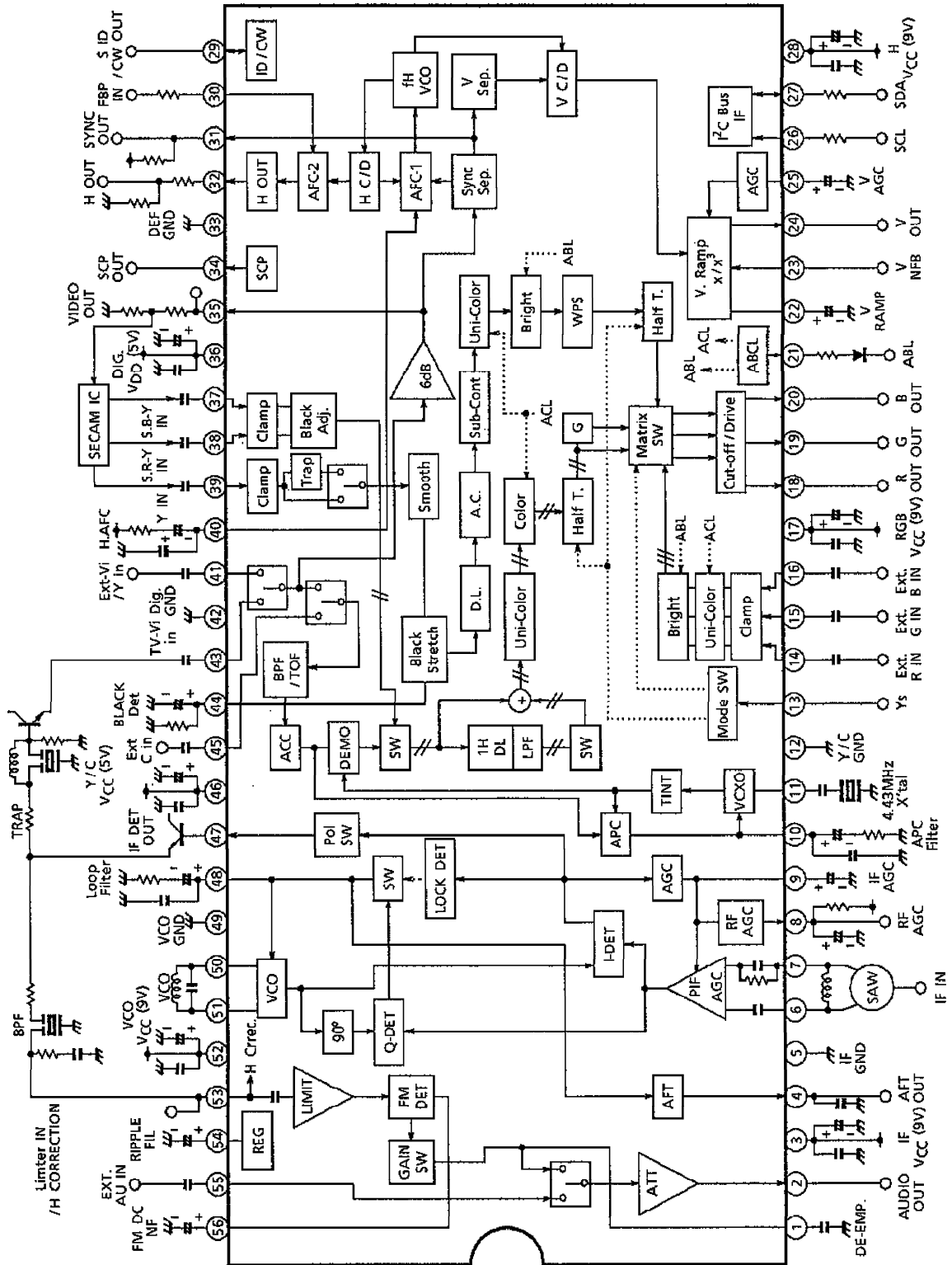

TB1231AN - 3

TERMINAL INTERFACE		FUNCTION	INTERFACE CIRCUIT	INPUT / OUTPUT
PIN No.	PIN NAME	FUNCTION	INTERFACE CIRCUIT	INPUT / OUTPUT
1	De-Emphasis	<p>The terminal to be connected with capacitor for de-emphasis.</p> <p>1500pF capacitance realizes $75\mu\text{s} / 50\mu\text{s}$ de-emphasis (switched by bus). The output impedance is as follows;</p> <p>PAL : $33\text{k}\Omega$ NTSC : $50\text{k}\Omega$</p>		<p>At PAL $927\text{mV}_{\text{rms}}$</p>
2	Audio Output	<p>The terminal for audio output.</p> <p>FM Det. signal or the signal inputted from Pin 55 is outputted (switched by bus). And its amplitude is controlled by bus.</p>		<p>At ATT Max. $927\text{mV}_{\text{rms}}$</p>

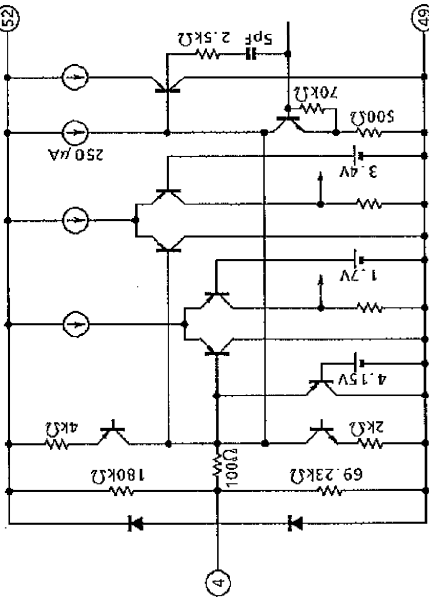
PIN No.	PIN NAME	FUNCTION	INTERFACE CIRCUIT	INPUT / OUTPUT
3	IF VCC (9V)	<p>The terminal for Vcc of PIF circuit. Supply 9V. In order to prevent leakage through VCC, inserting traps for IF carrier and fH is recommended.</p>	-	-
4	AFT Output / Self-Adj. Output	<p>The terminal for AFT output and Self-adj. output. AFT voltage, half of RF AGC Voltage, Red signal or Blue signal is outputted (Switched by bus). And AFT polarity is turned over by bus. AFT output impedance is 50Ω.</p>		0.3V~4.7V
5	IF GND	<p>The terminal for GND of PIF circuit. In order to realize good PIF Det. performance for low IF input, separate IF GND wiring from VCO GND (Pin 49) as far as possible.</p>	-	-

PIN No.	PIN NAME	FUNCTION	INTERFACE CIRCUIT	INPUT / OUTPUT
6 7	IF Input	The terminal for IF signal input. Pin 6 & Pin 7 are the both input poles of a differential amplifier.		Typical input 90dB/μV
8	RF AGC	The terminal for RF AGC output (Open corrector Output). To get rid of noises, connect a capacitor to this terminal.		0V~9V

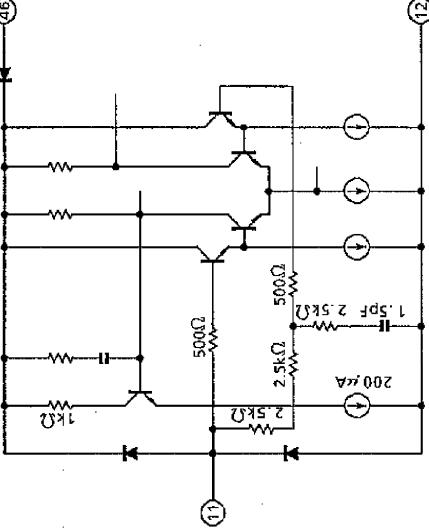
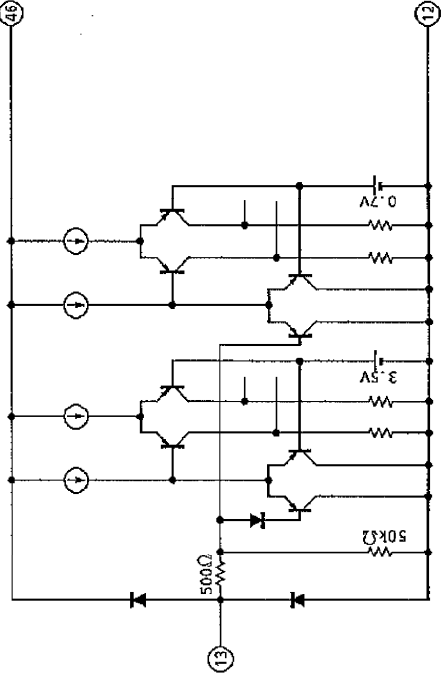

PIN No.	PIN NAME	FUNCTION	INTERFACE CIRCUIT	INPUT / OUTPUT
9	IF AGC	<p>The terminal to be connected with an IF AGC filter. Peak AGC works in sync. tip level of PIF Det. signal. For L-SECAM, Peak AGC works on VITS signal.</p>		2V~8V
10	APC Filter	<p>The terminal to be connected with APC filter for chroma demodulation. This terminal voltage controls the frequency of VCXO.</p>		—

PIN No.	PIN NAME	FUNCTION	INTERFACE CIRCUIT	INPUT / OUTPUT
11	X'tal	<p>The terminal to be connected with a 4.433619MHz X'tal oscillator.</p> <p>This is the standard of both of 4.43MHz / 3.58MHz chroma demodulation and horizontal VCO.</p> <p>MIL : HC-49 / U is recommended.</p>		—
12	Y/C GND	The terminal for GND of Y/C circuit.	—	—
13	Ys	<p>The terminal for switching of Analog RGB Mode.</p> <p>On Analog RGB Mode, the signal inputted into Pin 14, 15, 16 are outputted from Pin 18, 19, 20.</p>		<p>ANA RGB -----0.7V</p> <p>TV -----GND</p>

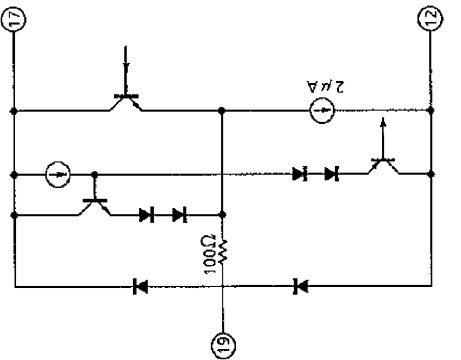
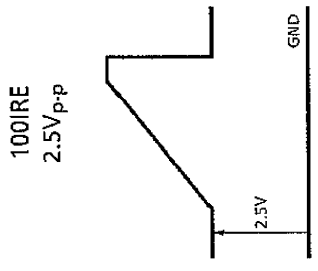
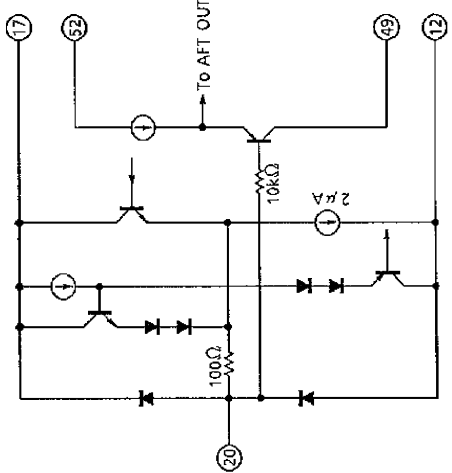
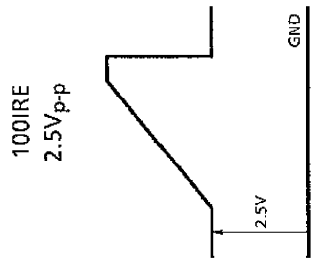
PIN No.	PIN NAME	FUNCTION	INTERFACE CIRCUIT	INPUT / OUTPUT
14	Analog R Input	The terminal for Analog RGB signals input.		<p>100IRE 0.5V p-p</p>
15	Analog G Input	Input signals are clamped by charging / discharging coupling capacitors, therefore		
16	Analog B Input	input with low impedance. 100Ω or less is recommended.		
17	RGB Vcc (9V)	The terminal for Vcc of RGB circuit (TEXT circuit). Supply 9V.		<p>—</p>
18	R Output	The terminals for R signals output. Because of the limit of output current, set the resistance 2.0kΩ or more to GND.		<p>100IRE 2.5V p-p</p>

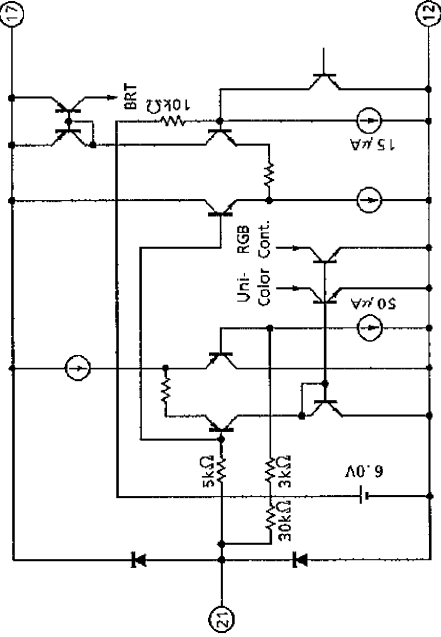
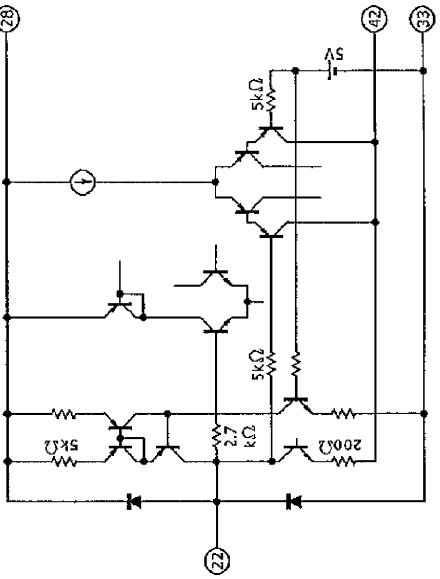
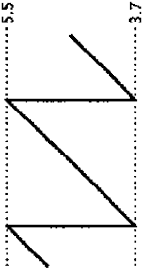
PIN No.	PIN NAME	FUNCTION	INTERFACE CIRCUIT	INPUT / OUTPUT
19	G Output	The terminals for G signals output. Because of the limit of output current, set the resistance 2.0kΩ or more to GND.	 <p>The diagram shows a circuit for the G Output. It features a 100Ω resistor connected to pin 19. The circuit includes several transistors and diodes. A 2kA current source is indicated. Pins 17 and 12 are also shown in the circuit.</p>	 <p>The waveform shows a signal with a 100IRE (100ns) rise time and a 2.5V peak-to-peak amplitude. The signal is shown relative to a GND reference.</p>
20	B Output	The terminals for B signals output. Because of the limit of output current, set the resistance 2.0kΩ or more to GND.	 <p>The diagram shows a circuit for the B Output. It features a 100Ω resistor connected to pin 20. The circuit includes several transistors and diodes. A 2kA current source and a 10kΩ resistor are indicated. Pins 17, 52, 99, and 12 are also shown in the circuit. The output is labeled 'To AFT OUT'.</p>	 <p>The waveform shows a signal with a 100IRE (100ns) rise time and a 2.5V peak-to-peak amplitude. The signal is shown relative to a GND reference.</p>

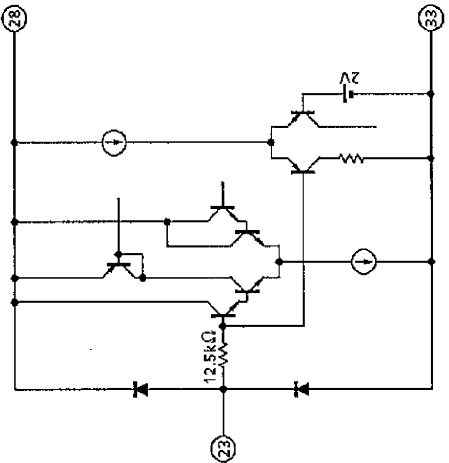
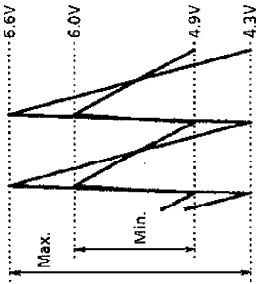
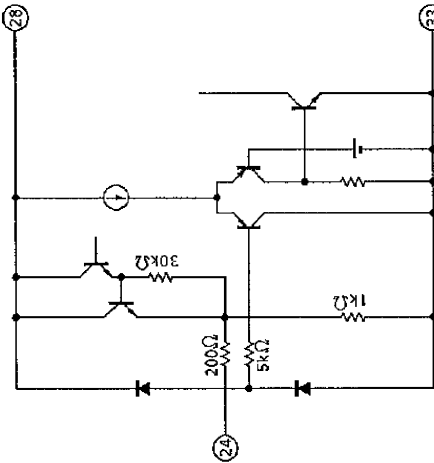

PIN No.	PIN NAME	FUNCTION	INTERFACE CIRCUIT	INPUT / OUTPUT
21	ABCL	<p>The terminal for ABL/ACL control. Control voltage range is 4.5V~6.0V. ABL Gain & ABL start point are selectable by bus.</p>		<p>At Open 6V</p>
22	V.Ramp	<p>The terminal to be connected with a capacitor to make V.Ramp signal. V.Ramp amplitude is kept constant by V.AGC function.</p>		

PIN No.	PIN NAME	FUNCTION	INTERFACE CIRCUIT	INPUT / OUTPUT
23	V.NFB	<p>The terminal for input of V.sawteeth signal feedback. The amplitude of feedback signal is controlled by bus.</p>		
24	V.Output	<p>The terminal for output of Vertical drive signal.</p>		

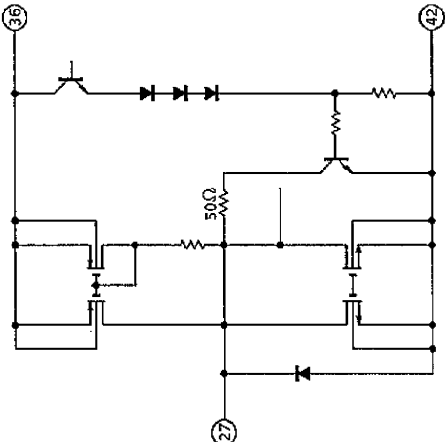
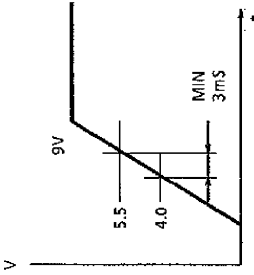
PIN No.	PIN NAME	FUNCTION	INTERFACE CIRCUIT	INPUT / OUTPUT
25	V.AGC	The terminal to be connected with a capacitor for V.AGC. V.AGC keeps V.Ramp amplitude constant.		-
26	SCL	The terminal for input of I ² C bus clock.		-

PIN No.	PIN NAME	FUNCTION	INTERFACE CIRCUIT	INPUT / OUTPUT
27	SDA	The terminal for input/output of I ² C bus data.		—
28	H. Vcc (9V)	The terminal for Vcc of deflection circuit. Supply 9V. For 4V or more, VCXO oscillates and for 5.5V or more, H OUT signal is outputted. Set the raising time between 4V and 5.5V longer than 3ms.	—	

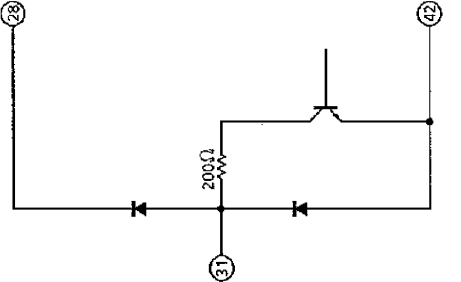
PIN No.	PIN NAME	FUNCTION	INTERFACE CIRCUIT	INPUT / OUTPUT
29	ID In/Output/ Fsc CW Output	<p>The terminal for PAL/NTSC ID output and SECAM ID input. By drawing out $150\mu\text{A}$ or more from this terminal, this IC turns to be SECAM mode. And the terminal for chroma sub-carrier frequency is switched by bus (Fixed 4.43MHz / Auto).</p>		<p>PAL/NTSC</p> <p>B/W</p>
30	FBP Input	<p>The terminal for FBP Input.</p>		

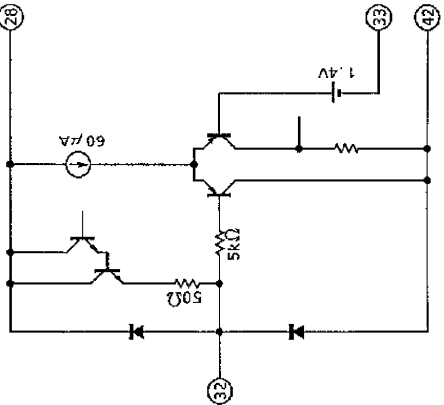
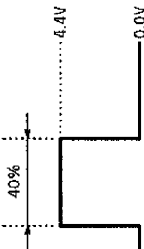
PIN No.	PIN NAME	FUNCTION	INTERFACE CIRCUIT	INPUT / OUTPUT
31	SYNC Output	The terminal for composite sync. output (Open corrector output).		
32	H. Output	The terminal for output of horizontal drive signal.		

PIN No.	PIN NAME	FUNCTION	INTERFACE CIRCUIT	INPUT / OUTPUT
33	DEF GND	The terminal for GND of deflection circuit.	---	---
34	SCP Output	The terminal for Sand Castle Pulse (VD + HD + Gp) output.		
35	Video SW Output	The terminal for Video Switch output. The signal inputted into Pin 41 or 43 is outputted through 6dB AMP.		2V _{p-p}

PIN No.	PIN NAME	FUNCTION	INTERFACE CIRCUIT	INPUT / OUTPUT
36	Dig. VDD (5V)	The Terminal for VDD of digital block. Supply 5V.	—	—
37	SECAM B-Y Input	The terminal for SECAM B-Y/R-Y input. Input signals are clamped by charging / discharging coupling capacitors, therefore input with low impedance.		
38	SECAM R-Y Input	The terminal for SECAM R-Y input. Input signals are clamped by charging / discharging coupling capacitors, therefore input with low impedance.		
39	Y Input	The terminal for Y input. Input signal is clamped by charging / discharging coupling capacitor, therefore input with low impedance. Typical input amplitude is 1.0V _{p-p} .		

PIN No.	PIN NAME	FUNCTION	INTERFACE CIRCUIT	INPUT / OUTPUT
40	H. AFC	<p>The terminal to be connected with H.AFC filter.</p> <p>This terminal voltage controls H. frequency.</p>		
41	EXT. Video / Y Input	<p>The terminal for input of composite signal or Y signal from TV's ext. Jack.</p> <p>One of input terminal of video SW.</p> <p>This is also the terminal for sync. signal input. Input with low impedance.</p> <p>Typical input amplitude is 1.0V_{p-p}.</p>		
42	Dig. GND	The terminal for GND of digital block.	-	-

PIN No.	PIN NAME	FUNCTION	INTERFACE CIRCUIT	INPUT / OUTPUT
43	TV Input	<p>The terminal for input of composite video signal from PIF Det. output.</p> <p>One of input terminal of video SW.</p> <p>This is also the terminal for sync. signal input. Input with low impedance. Typical input amplitude is 1.0V_{p-p}.</p>		
44	Black Det.	<p>The terminal to be connected with Black Det. filter.</p> <p>This terminal voltage controls Black stretching gain.</p>		

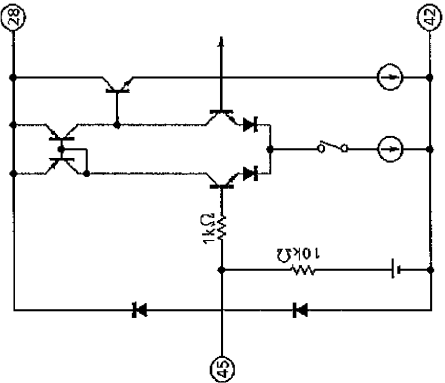
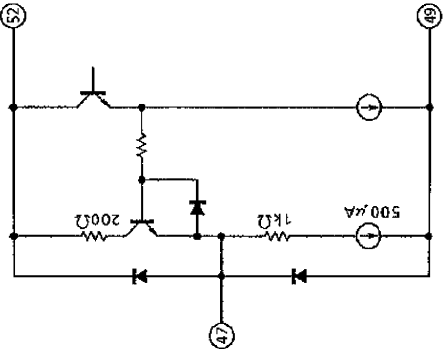
PIN No.	PIN NAME	FUNCTION	INTERFACE CIRCUIT	INPUT / OUTPUT
45	EXT. C Input	The terminal for input of chroma signal from TV's ext. jack. Input through a coupling capacitor.		Burst Amplitude 285mV _{p-p}
46	Y/C VCC (5V)	The terminal for VCC of Y/C circuit. Supply 5V.	—	—
47	IF Det. Output	The terminal for output of composite video signal and SIF signal detected in IF circuit. Typical video output amplitude is 2.2V _{p-p} . In order to reduce 920kHz beat, connect a emitter follower to drive audio trap and band-pass-filter.		2V _{p-p}

PIN No.	PIN NAME	FUNCTION	INTERFACE CIRCUIT	INPUT / OUTPUT
48	Loop Filter	<p>The terminal to be connected with loop filter for IF PLL. This terminal voltage controls the frequency of IF VCO.</p>		-
49	VCO GND	<p>The terminal for GND of VCO and SIF circuit. In order to realize good PIF Det. performance for low IF input, please separate VCO GND wiring from IF GND (Pin 5) as far as possible.</p>		-

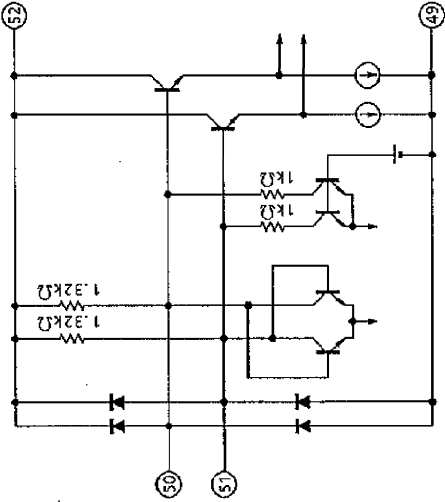
PIN No.	PIN NAME	FUNCTION	INTERFACE CIRCUIT	INPUT / OUTPUT
50 51	VCO	<p>The terminal to be connected with a tank coil for IF VCO. IF VCO frequency is controlled by bus. For 27pF ext. capacitance, frequency variable range is $\pm 2\text{MHz}$.</p>		-
52	VCO VCC (9V)	<p>The terminal for VCC of IF VCO and SIF. Supply 9V. In order to prevent leakage through VCC, inserting traps for IF carrier and fH is recommended.</p>	-	-

PIN No.	PIN NAME	FUNCTION	INTERFACE CIRCUIT	INPUT / OUTPUT
53	Limiter Input / H. Correction	<p>The terminal for SIF signal input and H. curve correction. By this terminal DC (3.5V~5.5V), it is possible to adjust H. phase ($-1\mu s \sim +1\mu s$). This can be used to correct horizontal curve caused by change of High-Voltage.</p>		<p>Typical 90dB/μV</p>
54	Ripple Filter	<p>The terminal to be connected with a capacitor to stabilize the performance of SIF injection-lock circuit.</p>		<p>—</p>

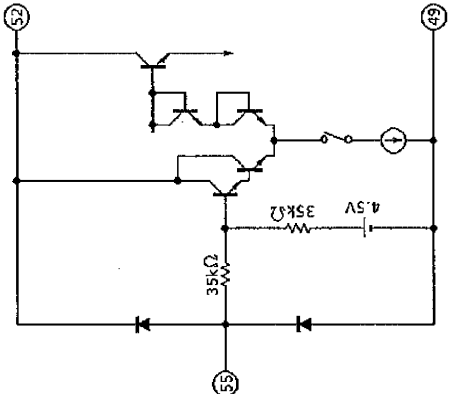
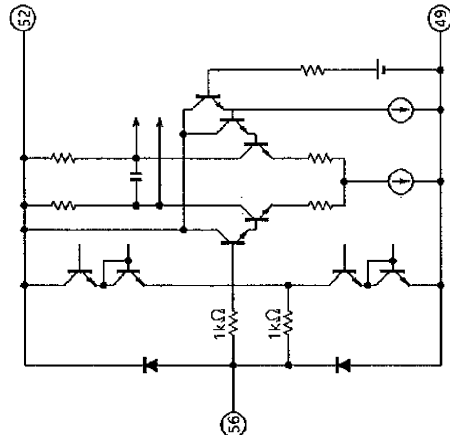
PIN No.	PIN NAME	FUNCTION	INTERFACE CIRCUIT	INPUT / OUTPUT
55	EXT. Audio Input	<p>The terminal for input of audio signal from TV's ext. jack. Input through a coupling capacitor. The signal inputted into this terminal is outputted from Pin 2 after passing audio SW and attenuator. Input impedance is 70kΩ.</p>		Center DC 4.5V
56	FM DC NF	<p>The terminal for FM DC Negative Feedback. Connect a capacitor to stabilize audio output DC level.</p>		DC : 5.2V

BUS CONTROL MAP

Write mode

Slave address : 88HEX

SUB ADDRESS	D7 MSB	D6	D5	D4	D3	D2	D1	D0 LSB	PRESET DATA	
									MSB	LSB
00	Au Gain	WPS	Uni-Color (TV)						0000	0000
01	Mute	Brightness (TV / TEXT)						0100	0000	
02		Color						1100	0000	
03	V AGC	TINT						0100	0000	
04	AF-G	Vi Pol	Sharpness						0010	0000
05	BPF / TOF SW	C-Trap	Au SW	Video SW		Half Tone	ABL Gain		0000	0000
06	Color System			CW SW	Sub-Contrast				0000	1000
07	R Cut Off						1000	0000		
08	G Cut Off						1000	0000		
09	B Cut Off						1000	0000		
0A	AFT Pol	G Drive Gain						0100	0000	
0B	AFT M	B Drive Gain						0100	0000	
0C	Vertical Position			Horizontal Position				0001	0000	
0D	B.B.	Audio ATT						0000	0000	
0E	V-Freq		RF AGC				0000	0000		
0F	AFC Gain		Vertical Size				0010	0000		
10	V Linearity			VS Correction				1000	1000	
11	PIF VCO						(Fix 0)	1000	0000	
12	SECAM R-Y Black Adj			SECAM B-Y Black Adj				1000	1000	
13	N-Com	BLK	RGB Contrast				0000	0000		
14	*	H-STP	F ID	Self Adj.		ID SW	ABL Start Point		0000	0000
15	TEST MODE						0000	0000		

Read mode

Slave address : 89HEX

7 MSB	6	5	4	3	2	1	0 LSB
POR	IF Lock	H Lock	IF Level	V Frq.	Color System		
Y-IN	RGB OUT	H-OUT	V-OUT	*	V Lock	AFT	

BUS CONTROL CONTENTS

Write mode

CHARACTERISTIC	DESCRIPTION	PRESET
Au Gain (Audio Gain SW)	0 : 50kHz 1 : 25kHz (X2 on 4.5MHz mode)	50kHz
WPS (White Peak Suppressor)	0 : ON 1 : OFF	ON
Uni-Color	Min : -11.6dB~Cen : 6.6dB~Max : 11.6dB	-11.6dB
Mute (Mute Mode)	00 : Normal 01 : Y-Mute 10 : RGB Out-Cut Off DC 11 : RGB Out-Cut Off DC + VP Out Hi (Service mode)	Y-Mute
Brightness	Min : 1.9V~Cen : 2.6V~Max : 3.4V (Pedestal Level)	2.6V
Color	Min : -20dB or less~Cen : 0dB~Max : 8.15dB	0dB
V-AGC (Vertical AGC Speed)	0 : Normal 1 : x3	Normal
TINT	Min : -38°~Cen : 0°~Max : 38°	0°
AF-G (AF Gain SW)	0 : 50 μ s (5.5 / 6.0 / 6.5MHz) 1 : 75 μ s (4.5MHz)	50 μ s
Vi POL (Video Polarity)	0 : Normal 1 : Reverse (For L-SECAM)	Normal
Sharpness	Min : -11dB~Cen : 5dB~Max : 12dB	0dB
BPF/TOF SW	0 : BPF 1 : TOF	BPF
C-Trap (Chroma Trap)	0 : OFF 1 : ON	OFF
AU SW (Audio SW)	0 : TV 1 : EXT.	TV
Video SW	00 : TV 01 : EXT. 10 : TV Y/C 11 : EXT Y/C	TV
Half Tone	0 : OFF 1 : ON	OFF
ABL Gain	00 : -0.74V 01 : -0.64V 10 : -0.37V 11 : -0.12V	-0.74V
Color System	000 : Auto1...443PAL / 358NTSC (/ SECAM) / 443NTSC 001 : Auto2...358NTSC / M-PAL / N-PAL 010 : Fixed 443PAL 011 : Fixed M-PAL 100 : Fixed N-PAL 101 : Fixed 358NTSC 110 : Fixed 443NTSC 111 : SECAM	Auto1
CW SW	0 : Auto 1 : 4.43MHz	Auto
Sub-Contrast	Min : -3.5dB~Cen : 0dB~Max : 2.3dB	0dB
RGB Cut Off	Min : -0.5V~Cen : 0V~Max : 0.5V	\pm 0dB
G/B Drive	Min : -5.5dB~Cen : 0dB~Max : 3.5dB	-5dB
AFT Polarity	0 : Normal 1 : Reverse (For L-SECAM)	Normal
AFT M (AFT Mute)	0 : Normal 1 : Mute	Normal
Vertical Position	000 : 0H 111 : 7H Delay / Pulse Width : 8H	0H
Horizontal Position	Min : -3 μ s~Cen : 0 μ s~Max : 3 μ s	0 μ s
B.B. (Blue Back)	0 : OFF 1 : 50IRE	OFF
Audio ATT	Min : -85dB~Cen : -15dB~Max : 0dB	Min
V-Freq (Vertical Frequency)	00 : Auto 01 : 60Hz 10 : 263H Fixed 11 : 313H Fixed	Auto
RF AGC	000000 : IF Mute Min : 65dB μ V~Max 100dB μ V	IF Mute
AFC Gain	00 : Normal 01 : 1/3 10 : x3 at VBLK 11 : AFC Off	Normal
Vertical Size	Min : -40%~Cen : 0%~Max : 40%	0%

CHARACTERISTIC	DESCRIPTION	PRESET
V Linearity	Upper Side ; Min : 16%~Cen : 0%~Max : - 14% Lower Side ; Min : - 20%~Cen : 0%~Max : 17.5%	0%
V-S Correction	Upper Side ; Min : 12%~Cen : 0%~Max : - 12% Lower Side ; Min : 15%~Cen : 0%~Max : - 15%	0%
PIF VCO (PIF VCO f ₀ Adj.)	Min : - 2MHz~Cen : 0MHz~Max : 2MHz	0MHz
SECAM R-Y Black Adj	Min : - 176mV~Cen : 0mV ~Max : 154mV (At R Output)	0mV
SECAM B-Y Black Adj	Min : - 280mV~Cen : 0mV~ Max : 245mV (At B Output)	0mV
N-Com (NTSC Comb SW)	0 : ON 1 : OFF	ON
BLK (Blanking SW)	0 : BLK ON 1 : BLK OFF	ON
RGB Contrast	Min : - 6.0dB~Cen : 9.4dB~Max : 14.0dB	- 6.0dB
H-STP (H-Out Stop)	0 : Normal 1 (& Mute data ; 11) : H-Out Stop & Low RGB Output	Normal
FID (Forced ID ON)	0 : Normal 1 : Killer OFF on Fixed System (This function doesn't work on Auto1 & Auto2 Mode.)	Normal
Self Adj. (AFT Output SW for Self Adj.)	00: AFT 01 : Blue 10 : Red 11 : RF AGC×1/2	AFT
ID SW (ID Sensitivity Switching)	0 : Normal Mode 1 : Low Mode	Normal
ABL Start Point	00 : -0.01V 01 : -0.11V 10 : -0.3V 11 : -0.45V	-0.01V
TEST (TEST MODE)	For factory-TEST. Leave these bits preset data.	00HEX

Read mode

CHARACTERISTIC	DESCRIPTION
POR (Power On Resection)	0 : Normal 1 : Resister Preset
IF Lock (IF Lock Detection)	0 : Lock Out 1 : Lock In
H-Lock (Horizontal Lock Detection)	0 : Lock Out 1 : Lock In
IF Level (IF AGC Gain Detection)	0 : High IF AGC Gain 1 : Low IF AGC Gain
V Frq (Vertical Frequency)	0 : 50Hz 1 : 60Hz
Color System	000 : B/W 001 : 4.43PAL 010 : M-PAL 011 : N-PAL 100 : 3.58NTSC 101 : 4.43NTSC 110 : SECAM 111 : N/A
Y-IN (For Self-Diagnostic)	0 : No Signal 1 : OK
RGB Output (For Self-Diagnostic)	0 : No Signal 1 : OK
H-OUT (For Self-Diagnostic)	0 : No Signal 1 : OK
V-OUT (For Self-Diagnostic)	0 : No Signal 1 : OK
V-Lock (Vertical Lock Detection)	0 : Lock Out 1 : Lock In
AFT (AFT Lock Detection)	00 : Lock Out 01 : High Freq. 10 : Low Freq. 11 : Lock In

I²C BUS CONTROLLED FORMAT SUMMARY

Bus controlled format of TB1231N is based on I²C Bus Control format of Philips.

Data transfer format

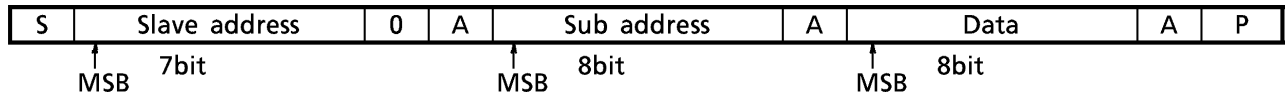

S : Start Condition
 P : Stop Condition
 A : Acknowledge

(1) Start and stop condition

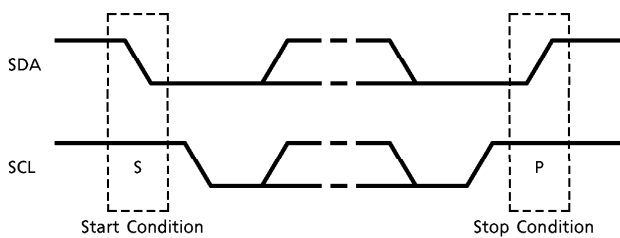

(2) Bit transfer

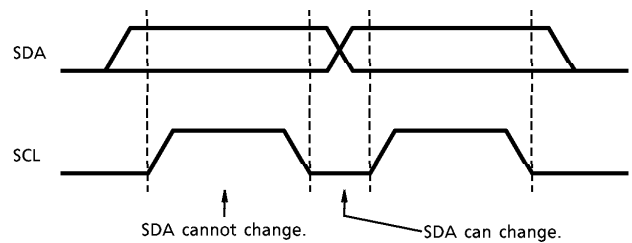

(3) Acknowledge

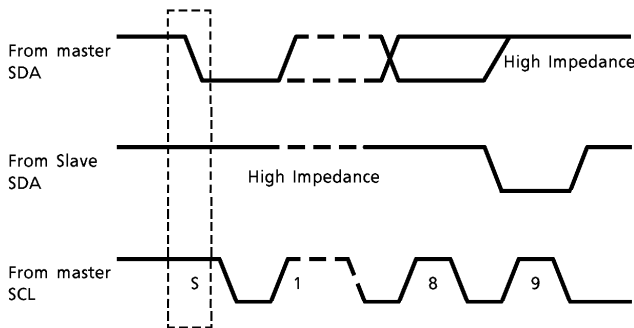

(4) Slave address

A ₆	A ₅	A ₄	A ₃	A ₂	A ₁	A ₀	R/ \overline{W}
1	0	0	0	1	0	0	0

Purchase of TOSHIBA I²C components conveys a license under the Philips I²C Patent Rights to use these components in an I²C system, provided that the system conforms to the I²C Standard Specification as defined by Philips.

MAXIMUM RATINGS (Ta = 25°C)

CHARACTERISTIC	SYMBOL	RATING	UNIT
Supply Voltage (9V V _{CC})	V _{CCmax9}	12	V
Supply Voltage (5V V _{CC})	V _{CCmax5}	8	V
Power Dissipation	PD _{max}	1980 (*)	mW
Input Terminal Voltage	V _{in}	GND - 0.3~V _{CC} + 0.3	V
Operating Temperature	T _{opr}	- 20~65	°C
Storage Temperature	T _{stg}	- 55~150	°C

(*) When using this device at above Ta = 25°C, the power dissipation decreases by 15.9mW per 1°C rise.

(*) Pin 9 and pin 36 are weak against static electricity and surge impulse. Please take counter measure to meet, if necessary.

Ta-PD CURVE

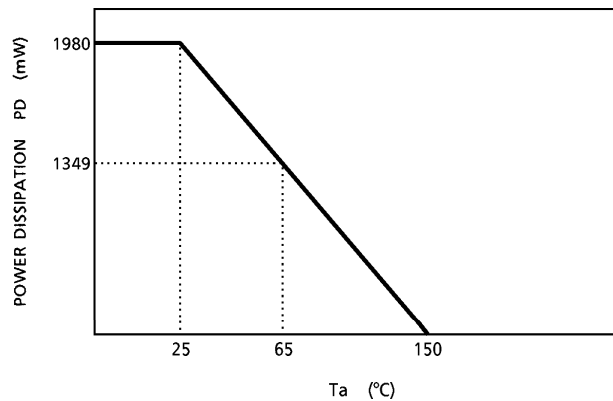

ELECTRICAL CHARACTERISTICS

DC CHARACTERISTICS

Pin voltage

PIN No.	PIN NAME	SYMBOL	TEST CIR-CUIT	TEST CONDITION	MIN.	TYP.	MAX.	UNIT
1	De-Emphasis	V ₁	—	—	4.5	5.0	5.5	V
2	Audio Output	V ₂	—	—	3.0	3.6	4.2	V
3	IF V _{CC}	V ₃	—	Supply 9V	—	9.0	—	V
4	AFT Output	V ₄	—	—	2.0	2.5	3.0	V
7	IF Input	V ₇	—	—	2.1	2.7	3.3	V
10	APC Filter	V ₁₀	—	—	1.8	2.5	3.2	V
11	X'tal	V ₁₁	—	—	37	4.0	4.3	V
13	Y _S	V ₁₃	—	—	—	0.17	0.4	V
14	Analog R Input	V ₁₄	—	—	1.8	2.5	3.2	V
15	Analog G Input	V ₁₅	—	—	1.8	2.5	3.2	V
16	Analog B Input	V ₁₆	—	—	1.8	2.5	3.2	V
17	RGB V _{CC}	V ₁₇	—	Supply 9V	—	9.0	—	V
18	R Output	V ₁₈	—	—	2.30	2.65	3.00	V
19	G Output	V ₁₉	—	—	2.30	2.65	3.00	V
20	B Output	V ₂₀	—	—	2.30	2.65	3.00	V
21	ABCL	V ₂₁	—	—	5.70	6.05	6.30	V
26	SCL	V ₂₆	—	—	4.5	5.0	5.5	V
27	SDA	V ₂₇	—	—	4.5	5.0	5.5	V
28	H.V _{CC}	V ₂₆	—	Supply 9V	—	9.0	—	V
29	ID In / Output / Fsc CW Output	V ₂₉	—	—	1.40	1.75	2.00	V
35	Video SW Output	V ₃₅	—	—	1.90	2.15	2.50	V
36	Digital V _{DD}	V ₃₆	—	Supply 5V	—	5.0	—	V
37	SECAM B-Y Input	V ₃₇	—	—	2.3	2.5	2.7	V
38	SECAM R-Y Input	V ₃₈	—	—	2.3	2.5	2.7	V
39	Y Input	V ₃₉	—	—	2.5	2.8	3.2	V
40	H.AFC	V ₄₀	—	—	6.0	6.8	7.5	V
41	Ext. Video / Y Input	V ₄₁	—	Video SW : 01	2.7	3.0	3.4	V
43	TV Video Input	V ₄₃	—	Video SW : 00	2.7	3.0	3.4	V
44	Black Detection	V ₄₄	—	—	2.00	2.25	2.60	V
45	Ext. C Input	V ₄₅	—	—	2.7	3.0	3.4	V
46	Y / C V _{CC}	V ₄₆	—	Supply 5V	—	5.0	—	V
47	PIF Det. Output	V ₄₇	—	—	4.8	5.3	5.8	V
48	Loop Filter	V ₄₈	—	—	4.1	4.6	5.1	V

PIN No.	PIN NAME	SYMBOL	TEST CIR-CUIT	TEST CONDITION	MIN.	TYP.	MAX.	UNIT
50	PIF VCO	V50	—	—	7.4	8.0	8.6	V
51	PIF VCO	V51	—	—	7.4	8.0	8.6	V
52	VCO V _{CC}	V52	—	Supply 9V	—	9.0	—	V
53	Limiter Input / Curre Correction	V53	—	—	3.9	4.5	5.1	V
54	Ripple Filter	V54	—	—	5.2	5.9	6.6	V
55	Ext. Audio Input	V55	—	—	3.8	4.4	5.0	V

Current dissipation

PIN No.	PIN NAME	SYMBOL	TEST CIR-CUIT	TEST CONDITION	MIN.	TYP.	MAX.	UNIT
3	IF V _{CC}	I _{CC3}	—	Supply 9V	8.5	15	19	mA
17	RGB V _{CC}	I _{CC17}	—	Supply 9V	8.5	12	14	mA
28	H.V _{CC}	I _{CC26}	—	Supply 9V	12	16	22	mA
36	Digital V _{CC}	I _{CC36}	—	Supply 5V	7	12	15	mA
46	Y/C V _{CC}	I _{CC46}	—	Supply 5V	45	65	76	mA
52	VCO V _{CC}	I _{CC52}	—	Supply 9V	15.5	23	29	mA

RECOMMENDED OPERATING POWER SUPPLY VOLTAGE

PIN No.	PIN NAME	MIN.	TYP.	MAX.	UNIT	NOTE
3	IF V _{CC}	8.5	9	9.5	V	—
17	RGB V _{CC}	8.5	9	9.5	V	—
28	H.V _{CC}	8.5	9	9.5	V	—
36	Digital V _{CC}	4.5	5	5.5	V	—
46	Y/C V _{CC}	4.5	5	5.5	V	The thermal drift of the Y /C V _{CC} should be less than 50mV
52	VCO V _{CC}	8.5	9	9.5	V	—

AC CHARACTERISTIC

PIF stage (Unless otherwise specified, $V_{CC} = 9V$ (3, 17, 28 & 52pin) / $5V$ (36 & 46pin), $T_a = 25^\circ C$)

CHARACTERISTIC		SYMBOL	TEST CIRCUIT	TEST CONDITION	MIN.	TYP.	MAX.	UNIT
PIF Det. Output Level	87.5%	V_{DET875}	—	P ₁	2.0	2.2	2.4	V_{p-p}
	L-SECAM	V_{DETL5}			2.0	2.2	2.4	
	110%	V_{DET110}			2.0	2.5	3.0	
PIF Input Sensitivity	MIN.	$E_{PIFINMIN}$	—	P ₂	—	37	—	$dB_{\mu V}$
	MAX.	$E_{PIFINMAX}$			100	107	—	
IF AGC Range		ΔE_{IFAGC}	—		65	70	—	dB
PIF Det. Sync. Tip Level		V_{SYNC}	—	P ₃	2.6	2.9	3.2	V
L-SECAM White Peak Level		V_{LSW}	—		4.6	4.9	5.2	V
Output Level for No Input	—	V_{NOIF}	—	P ₄	4.8	5.2	5.6	V
	L-SECAM	V_{NOIFLS}			2.2	2.6	3	
Differential Gain		DG	—	P ₅	—	2	5	%
Differential Phase		DP			—	2	5	°
PIF Output Freq. Response		FR_{DET}	—	P ₆	5	7	—	MHz
S/N		S/N_{PIF}	—	P ₇	52	55	—	dB
Intermodulation		I_{107}	—	P ₈	42	45	—	dB
I _F AGC Voltage	MAX.	$V_{IFAGCMAX}$	—	P ₉	7.3	7.5	—	V
	MIN.	$V_{IFAGCMIN}$			—	3.8	—	
R _F AGC Voltage	MAX.	$V_{RFAGCMAX}$	—	P ₁₀	—	9	—	V
	MIN.	$V_{RFAGCMIN}$			—	0.2	0.5	
R _F AGC Control Range		ΔE_{RFAGC}	—	P ₁₁	35	—	—	dB
AFT Center Voltage		V_{AFTCEN}	—	P ₁₂	—	2.5	—	V
AFT Voltage	MAX.	V_{AFTMAX}	—	P ₁₃	4.4	4.8	5.2	V
	MIN.	V_{AFTMIN}			—	0.2	0.5	
AFT Sensitivity		μAFT	—	P ₁₄	—	40	—	kHz/V
PIF VCO Control Sensitivity		β_{IFVCO}	—	P ₁₅	—	2.5	—	MHz/V
PIF VCO Pull-In Range	High	F_{PIFINH}	—	P ₁₆	1	1.5	—	MHz
	Low	F_{PIFINL}			1	1.5	—	

SIF & audio stage (Unless otherwise specified, V_{CC} = 9V (3, 17, 28 & 52pin) / 5V (36 & 46pin), T_a = 25°C)

CHARACTERISTIC		SYMBOL	TEST CIR-CUIT	TEST CONDITION	MIN.	TYP.	MAX.	UNIT
FM Det. Output Level	5.5MHz / P	V _{AUAC5P}	—	S ₁	695	927	1236	mV _{rms}
	4.5MHz / P	V _{AUAC4P}			649	927	1324	
	4.5MHz / N	V _{AUAC4N}			350	500	700	
Audio Distortion	5.5MHz / P	D _{AUDIOP}	—	S ₂	—	0.3	1	%
	4.5MHz / P	D _{AUDION}			—	0.3	1	
Audio S / N	5.5MHz / P	S / N _{SIFP}	—	S ₃	55	60	—	dB
	4.5MHz / P	S / N _{SIFN}			52	58	—	
AMR		AMR	—	S ₄	50	60	—	dB
Limiting Sensitivity		E _{LIM}	—	S ₅	—	35	—	dB _{μV}
Band Width (5.5MHz / PAL)	High	F _{AUH5P}	—	S ₆	6.7	8.7	—	MHz
	Low	F _{AUL5P}			—	3.8	5.4	
Band Width (4.5MHz / NTSC)	High	F _{AUH4N}	—	S ₇	4.9	6.4	—	
	Low	F _{AUL4N}			—	2.8	4	
Attenuator Gain	MAX.	G _{ATTMAX}	—	S ₈	—	0	—	dB
	CEN.	G _{ATTCEN}			—	-15	—	
	MIN.	G _{ATTMIN}			—	-85	-75	
Offset between TV / Ext		V _{AUOFFSET}	—	S ₉	-30	0	30	mV
DC Change by Volume		ΔV _{VOLDC}	—	S ₁₀	—	—	100	mV

Video stage (Unless otherwise specified, $V_{CC} = 9V$ (3, 17, 28 & 52pin) / $5V$ (36 & 46pin), $T_a = 25^\circ C$)

CHARACTERISTIC	SYMBOL	TEST CIR-CUIT	TEST CONDITION	MIN.	TYP.	MAX.	UNIT
TV Input Dynamic Range	DR _{TV}	—	V ₁	1.2	1.4	—	V _{p-p}
External Input Dynamic Range	DR _{EXT}			1.2	1.4	—	V _{p-p}
TV Mode Gain	G _{TV}	—	V ₂	4.8	5.6	6.0	dB
External Mode Gain	G _{EXT}			4.8	5.6	6.0	dB
AV SW Cross-Talk	CT _{SWTE}	—	V ₃	—	-55	-50	dB
	CT _{SWET}			—	-55	-50	dB
Y Input Dynamic Range	DR _Y	—	V ₄	1.1	1.3	—	V _{p-p}
Y Input Pedestal Clamp Voltage	V _{YCLP}	—	V ₅	2.5	2.7	2.9	V
Y Delay Time	t _{YDEL}	—	V ₆	500	550	600	ns
Brightness Chara.	V _{BRTMAX}	—	V ₇	3.0	3.4	3.7	V
	V _{BRTCEN}			2.3	2.6	2.8	
	V _{BRTMIN}			1.6	1.9	2.1	
Brightness Data Sensitivity	ΔV_{BRT}	—	V ₇	9.4	13.6	16.3	mV / bit
Uni-Color Chara. for Y	G _{UCYMAX}	—	V ₈	10.2	11.6	13.2	dB
	G _{UCYCEN}			5.1	6.6	8.3	
	G _{UCYMIN}			-9.1	-6.9	-5.2	
Sub-Contrast Chara.	G _{SCONMAX}	—	V ₉	1.8	2.3	2.8	dB
	G _{SCONMIN}			-3.0	-3.5	-4.0	
Sharpness Peaking Frequency	F _{SHP}	—	V ₁₀	3.0	3.3	3.6	MHz
Sharpness Control Characteristics	G _{SHMAX}	—	V ₁₁	7.0	12.0	15.0	dB
	G _{SHCEN}			2.0	5.0	7.0	
	G _{SHMIN}			-14.0	-11.0	-8.0	
Y Frequency Response	F _{RY}	—	V ₁₂	5.5	—	—	MHz
Black Expansion AMP Gain	G _{BLEX}	—	V ₁₃	1.2	1.4	1.6	—
Black Expansion Start Point	V _{BLEX}			0.9	1.1	1.3	V
Black Peak Detection Level	V _{BLPD}	—	V ₁₄	-50	0	50	mV
WPS Level	V _{WPS}	—	V ₁₅	2.5	2.8	3.2	V _{p-p}
Chrome Trap Gain	G _{TRAP 358}	—	V ₁₆	—	—	-20	dB
	G _{TRAP 443}			—	—	-20	dB
Half Tone Chara. for Y	G _{HTY}	—	V ₁₇	-6.9	-6.0	-5.1	dB

Chroma stage (Unless otherwise specified, $V_{CC}=9V$ (3, 17, 28 & 52pin) / $5V$ (36 & 46pin), $T_a=25^{\circ}C$)

CHARACTERISTIC	SYMBOL	TEST CIR-CUIT	TEST CONDITION	MIN.	TYP.	MAX.	UNIT		
ACC Chara.	V_{ACCL}	—	C_1	—	20	30	mV _{p-p}		
	V_{ACCH}			600	—	—			
TOF Chara. (4.43MHz)	F_{0T443}	—	C_2	—	5.13	—	MHz		
	Q_{T443}			—	2.0	—	—		
BPF Chara. (4.43MHz)	F_{0B443}			—	4.43	—	MHz		
	Q_{B443}			—	2.0	—	—		
TOF Chara. (3.58MHz)	F_{0T358}			—	4.28	—	MHz		
	Q_{T358}			—	2.0	—	—		
BPF Chara. (3.58MHz)	F_{0B358}			—	3.58	—	MHz		
	Q_{B358}			—	2.0	—	—		
C Delay Time	t_{CDEL}			—	C_3	550	600	650	ns
Delay Time Difference between Y/C	$\Delta t_{Y/C}$			—	C_3	-60	0	60	ns
Color Chara.	G_{COLMAX}	—	C_4	6.93	8.15	9.37	dB		
	G_{COLMIN}			—	—	-20			
Uni-Color Chara. for C	G_{UCCMIN}	—	C_5	-21.5	-18.8	-16.0	dB		
Tint Chara. (4.43MHz)	$\Delta \theta_{443MAX}$	—	C_6	30	38	46	deg		
	$\Delta \theta_{443MIN}$			-46	-38	-30			
Tint Chara. (3.58MHz)	$\Delta \theta_{358MAX}$			30	38	46	deg		
	$\Delta \theta_{358MIN}$			-46	-38	-30			
Relative Amplitude (PAL)	$V_{PR/B}$	—	C_7	0.45	0.55	0.65	—		
	$V_{PG/B}$			0.22	0.27	0.32			
Relative Amplitude (NTSC)	$V_{PR/B}$			0.6	0.7	0.8	—		
	$V_{PG/B}$			0.21	0.26	0.31			
Relative Phase (PAL)	θ_{PR-B}	—	C_8	85	90	95	deg		
	θ_{PG-B}			233	242	248			
Relative Phase (NTSC)	θ_{PR-B}			88	93	98	deg		
	θ_{PG-B}			233	242	247			
APC Pull-In Range (4.43MHz)	F_{4APCP+}	—	C_9	350	500	—	Hz		
	F_{4APCP-}			350	500	—			
APC Hold Range (4.43MHz)	F_{4APCH+}			350	500	—	Hz		
	F_{4APCH-}			350	500	—			
APC Pull-In Range (3.58MHz)	F_{3APCP+}			350	500	—	Hz		
	F_{3APCP-}			350	500	—			
APC Hold Range (3.58MHz)	F_{3APCH+}			350	500	—	Hz		
	F_{3APCH-}			350	500	—			
APC Control Sensitivity (4.43MHz)	β_{443}			—	C_{10}	0.8	1.0	1.2	Hz / mV
APC Control Sensitivity (4.43MHz)	β_{358}					0.7	0.9	1.1	Hz / mV

CHARACTERISTIC	SYMBOL	TEST CIRCUIT	TEST CONDITION	MIN.	TYP.	MAX.	UNIT
PAL ID Sensitivity (Normal Mode)	V _{PALIDON}	—	C ₁₁	1.0	3.0	5.0	mV _{p-p}
	V _{PALIDOFF}			1.0	3.0	5.0	
PAL ID Sensitivity (Low Mode)	V _{PALIDLON}			4.0	6.0	8.0	mV _{p-p}
	V _{PALIDLOFF}			4.0	6.0	8.0	
NTSC ID Sensitivity (Normal Mode)	V _{NTIDON}			0.4	0.8	1.2	mV _{p-p}
	V _{NTIDOFF}			0.4	0.8	1.2	
NTSC ID Sensitivity (Low Mode)	V _{NTIDLON}			0.6	1.2	1.8	mV _{p-p}
	V _{NTIDLOFF}			0.6	1.2	1.8	
ID Output Level	V _{IDH}	—	C ₁₂	2.9	3.2	3.5	V
	V _{IDL}			1.5	1.8	2.1	
SECAM ID Det. Current	I _{SECAM}	—	C ₁₃	80	120	160	μA
fsc Continuous Wave Output Level	V _{CW}	—	C ₁₄	0.35	0.50	0.70	V _{p-p}
Sub-Carrier Remain on RGB Output	V _{SCR}	—	C ₁₅	0	20	40	mV _{p-p}
	V _{SCG}			0	20	40	
	V _{SCB}			0	20	40	
Half Tone Chara. for C	G _{HTC}	—	C ₁₆	-6.9	-6.0	-5.1	dB

Text stage (Unless otherwise specified, $V_{CC} = 9V$ (3, 17, 28 & 52pin) / $5V$ (36 & 46pin), $T_a = 25^\circ C$)

CHARACTERISTIC	SYMBOL	TEST CIR-CUIT	TEST CONDITION	MIN.	TYP.	MAX.	UNIT	
V-BLK Pulse Output Level	V_{VBLK}	—	T_1	0.5	1.0	1.5	V	
H-BLK Pulse Output Level	V_{HBLK}			0.5	1.0	1.5	V	
RGB Output Black Level (0IRE DC)	V_{BLACK}	—	T_2	2.35	2.60	2.85	V	
RGB Output White Level (100IRE AC)	V_{WHITE}	—	T_3	—	2.50	—	V_{p-p}	
Cut-Off Voltage Variable Range	ΔV_{CUT+}	—	T_4	0.45	0.50	0.55	V	
	ΔV_{CUT-}			-0.55	-0.50	-0.45		
Drive Control Variable Range	$GDR+$	—	T_5	3.0	3.5	4.0	dB	
	$GDR-$			-6.0	-5.5	-5.0		
ABCL Control Voltage Range	V_{ABCLH}	—	T_6	6.0	6.1	6.2	V	
	V_{ABCLL}			5.4	5.5	5.6		
ACL Gain	G_{ACL}	—		-16.5	-15	-13.5	dB	
ABL Point	V_{ABLP1}	—	T_7	-0.06	-0.01	0.04	V	
	V_{ABLP2}			-0.16	-0.11	-0.06		
	V_{ABLP3}			-0.35	-0.30	-0.25		
	V_{ABLP4}			-0.47	-0.42	-0.37		
ABL Gain	V_{ABLG1}	—	T_8	-0.17	-0.12	-0.07	V	
	V_{ABLG2}			-0.42	-0.37	-0.32		
	V_{ABLG3}			-0.69	-0.64	-0.59		
	V_{ABLG4}			-0.79	-0.74	-0.69		
Analog RGB Dynamic Range	DR_{TX}	—	T_9	0.5	—	—	V_{p-p}	
Analog RGB Contrast Control Characteristic	MAX.	G_{TXCMAX}	—	T_{10}	0.85	1.00	1.20	V_{p-p}
	CEN.	G_{TXCCEN}			0.50	0.59	0.71	
	MIN.	G_{TXCMIN}			0.08	0.10	0.12	
Analog RGB Brightness Control Characteristic	MAX.	$V_{TXBRMAX}$	—	T_{11}	3.0	3.4	3.7	V
	CEN.	V_{TXBCEN}			2.3	2.6	2.8	
	MIN.	$V_{TXBRMIN}$			1.6	1.9	2.1	
Analog RGB Mode Switching Level	V_{YS}	—	T_{12}	0.6	0.8	1.0	V	
Analog RGB Mode Transfer Characteristic	τ_{RYS}	—	T_{13}	—	25	100	ns	
	t_{PRYS}			—	30	100		
	τ_{FYS}			—	10	100		
	t_{PFYS}			—	25	100		
Cross Talk from Analog RGB to TV	CT_{TX-TV}	—	T_{14}	—	-55	-50	dB	
Cross Talk from TV to Analog RGB	CT_{TV-TX}	—	T_{15}	—	-55	-50	dB	

CHARACTERISTIC		SYMBOL	TEST CIR-CUIT	TEST CONDITION	MIN.	TYP.	MAX.	UNIT
RGB Output Amplitude	R	V _{ROUT}	—	T ₁₉	1.0	1.2	1.4	V _{p-p}
	G	V _{GOUT}			0.45	0.60	0.75	
	B	V _{BOU}			2.0	2.2	2.4	
SECAM Black Level Adj. Chara.		V _{SECBMAX}	—	T ₂₀	210	245	280	mV
		—			—	—		
		V _{SECRMAX}			133	154	175	mV
		V _{SECBMIN}			-320	-280	-240	
SECAM Black Level Adj. Data Sensitivity		V _{SECRMIN}	—	T ₂₀	-200	-176	-152	mV
		ΔV _{SECB}			30	35	40	
		ΔV _{SECR}			19	22	25	mV

1H DL stage (Unless otherwise specified, V_{CC} = 9V (3, 17, 28 & 52pin) / 5V (36 & 46pin), Ta = 25°C)

CHARACTERISTIC		SYMBOL	TEST CIR-CUIT	TEST CONDITION	MIN.	TYP.	MAX.	UNIT
1H DL Dynamic Range (Direct)	DR _{BDR}	—	—	Pin 37~Pin 20	0.8	1.2	—	V
	DR _{RDR}			Pin 38~Pin 18	0.8	1.2	—	
1H DL Dynamic Range (Delay)	DR _{PDL}	—	—	Pin 37~Pin 20	0.8	1.2	—	V
	DR _{PDL}			Pin 38~Pin 18	0.8	1.2	—	
1H DL Dynamic Range (Direct + Delay)	DR _{BDRDL}	—	—	Pin 37~Pin 20	0.9	1.2	—	V
	DR _{RDRDL}			Pin 38~Pin 18	0.9	1.2	—	
Frequency Response (Direct)	FR _{BDR}	—	—	At 700kHz	-3.0	-2.0	0.5	dB
	FR _{RDR}			At 700kHz	-3.0	-2.0	0.5	
Frequency Response (Delay)	FR _{BDL}	—	—	At 700kHz	-8.2	-6.5	-4.3	dB
	FR _{RDL}			At 700kHz	-8.2	-6.5	-4.3	
AC Gain (Direct)	GB _{DR}	—	—	Pin 37~Pin 20	-2.0	-0.5	2.0	dB
	GR _{DR}			Pin 38~Pin 18	-2.0	-0.5	2.0	
AC Gain (Delay)	GB _{DL}	—	—	Pin 37~Pin 20	-2.4	-0.5	1.1	dB
	GR _{DL}			Pin 38~Pin 18	-2.4	-0.5	1.1	
Direct-Delay AC Gain Difference	ΔGB _{DR} / DL	—	—	GB _{DR} -GB _{DL}	-1.0	0.0	1.0	dB
	ΔGR _{DR} / DL			GR _{DR} -GR _{DL}	-1.0	0.0	1.0	
1H Delay Time	T _{BDL}	—	—	Pin 37~Pin 20	63.7	64.0	64.4	μs
	T _{RDL}			Pin 38~Pin 18	63.7	64.0	64.4	

DEF stage (Unless otherwise specified, $V_{CC} = 9V$ (3, 17, 28 & 52pin) / $5V$ (36 & 46pin), $T_a = 25^\circ C$)

CHARACTERISTIC		SYMBOL	TEST CIR-CUIT	TEST CONDITION	MIN.	TYP.	MAX.	UNIT
AFC Inactive Period	50Hz	$T_{50AFCOFF}$	—	D ₁	—	309-8	—	H
	60Hz	$T_{60AFCOFF}$	—		—	256-10	—	
H-OUT Start Voltage		V_{HON}	—	D ₂	4.7	5.0	5.3	V
H-OUT Pulse Duty		W_{HOUT}	—	D ₃	38.5	40.5	42.5	%
H-OUT Freq. on AFC Stop Mode		$F_{HAFCOFF}$	—	D ₄	15.585	15.734	15.885	kHz
Horizontal Free-Run Frequency	50Hz	F_{H50FR}	—	D ₅	15.745	15.625	15.775	kHz
	60Hz	F_{H60FR}			15.585	15.734	15.885	
Horizontal Freq. Variable Range	MAX.	F_{HMAX}	—	D ₆	16.500	16.700	16.900	kHz
	MIN.	F_{HMIN}			14.700	15.000	15.300	
Horizontal Freq. Control Sensitivity		β_{HAFC}	—	D ₇	2.0	2.5	3.0	Hz / mV
Horizontal Pull-In Range		F_{HPPH}	—	D ₈	500	—	—	Hz
		F_{HPL}			500	—	—	
H-OUT Voltage		V_{HOUTH}	—	D ₉	4.0	4.4	4.8	V
		V_{HOUTL}			—	0.15	0.30	
Horizontal Freq. Dependence on V_{CC}		ΔF_{HVCC}	—	D ₁₀	-20	0	20	Hz / V
FBP Phase		PH_{FBP}	—	D ₁₁	2.3	2.5	2.7	μs
H-Sync. Phase		PH_{HSYNC}			0.2	0.3	0.4	
Horizontal Position Variable Range		ΔPH_{HPOS}	—	D ₁₂	5.5	6.0	6.5	μs
AFC-2 Pulse Threshold Level		V_{AFC2}	—	D ₁₃	4.7	5.0	5.3	V
H-BLK Pulse Threshold Level		V_{HBLK}	—	D ₁₄	0.8	1.1	1.4	
Black Peak Det. Stop Period (H)		PH_{BPDET}	—	D ₁₅	7.5	8.0	8.5	μs
		W_{BPDET}			13.0	13.5	14.0	
Clamp Pulse Start Phase		PH_{CP}	—	D ₁₆	2.8	3.0	3.2	μs
Clamp Pulse Width		W_{CP}			5.6	5.8	6.0	
Gate Pulse Start Phase		PH_{GP}	—	D ₁₇	2.7	2.9	3.1	μs
Gate Pulse Width		W_{GP}			1.8	2.0	2.2	
Sync. Output Low Level		V_{SYNCL}	—	D ₁₈	0.0	0.3	0.5	V
Vertical Oscillation Start Voltage		V_{VON}	—	D ₁₉	4.7	5.0	5.3	V
Vertical Free-Run Frequency	Auto	F_{VAUFR}	—	D ₂₀	40	45	50	Hz
	60Hz	F_{V60FR}			48	53	58	
Gate Pulse V-Masking Period	50Hz	T_{50GPM}	—	D ₂₁	—	308-9	—	H
	60Hz	T_{60GPM}			—	261-10	—	
V.Ramp DC on Service Mode		$V_{NOVRAMP}$	—	D ₂₂	3.0	3.2	3.4	V
Vertical Pull-In Range (Auto)		F_{VPAUL}	—	D ₂₃	—	224.5	—	H
		F_{VPAUH}			—	353	—	
Vertical Pull-In Range (60Hz)		F_{VP60L}	—	D ₂₃	—	224.5	—	H
		F_{VP60H}			—	297	—	

CHARACTERISTIC	SYMBOL	TEST CIRCUIT	TEST CONDITION	MIN.	TYP.	MAX.	UNIT
Vertical Period on Fixed Mode	TV313	—	D24	—	313	—	H
	TV263			—	263	—	
V-BLK Start Phase	50Hz PH50VBLK	—	D25	44	46	48	μ s
	60Hz PH60VBLK			44	46	48	
V-BLK Width	50Hz W50VBLK	—	D25	—	23	—	H
	60Hz W60VBLK			—	21	—	
Picture Mute Period	50Hz W50PM	—	D26	—	304-29	—	H
	60Hz W60PM			—	257-28	—	
Sand Castle Pulse Level	VSCPH	—	D27	7.70	8.00	8.30	V
	VSCPM			4.00	4.30	4.60	
	VSCPL			2.25	2.55	2.85	
Vertical Ramp Amplitude	VVRAMP	—	D28	1.50	1.67	1.83	V _{p-p}
Vertical AMP Gain	GVAMP	—	D29	22	25	28	dB
Vertical AMP Max. Output Level	VVOMAX			2.5	3.0	3.5	V
Vertical AMP Min. Output Level	VVOMIN			—	0.0	0.3	V
Vertical AMP Min. Output Current	IVOMAX	—	D30	11	14	17	mA
Vertical NFB Amplitude	VNFB	—	D31	1.50	1.67	1.83	V _{p-p}
Vertical Amplitude Variable Range	Δ VVRAMPH			36	40	44	%
	Δ VVRAMPL	-44	-40	-36			
Vertical Linearity Variable Range	Δ V _{LIN1} +	—	D32	-17	-14	-11	%
	Δ V _{LIN1} -			13	16	19	
	Δ V _{LIN2} +			14.5	17.5	20.5	
	Δ V _{LIN2} -			-23	-20	-17	
Vertical S Correction Variable Range	Δ V _{S1} +	—	D33	-14	-12	-10	%
	Δ V _{S1} -			10	12	14	
	Δ V _{S2} +			-18	-15	-12	
	Δ V _{S2} -			12	15	18	
V-AGC Current	IVAGCH	—	D34	440	550	660	μ A
	IVAGCL			100	120	140	μ A
Vertical Guard Voltage	VVG	—	D35	1.80	2.00	2.20	V

TEST CONDITION

PIF stage (Unless otherwise specified, $V_{CC} = 9V$ (3, 17, 28 & 52pin) / $5V$ (36 & 46pin), $T_a = 25^\circ C$)

NOTE	ITEM / SYMBOL	BUS CONDITION	MEASUREMENT METHOD
P1	PIF Det. Output Level /VDET875 /VDETLS /VDET110	RF AGC : except 0 PIF VCO : adjust V _i Pol : 0 / 1 Others : Preset	(1) Input a 38.9MHz, 90dB μ V, 87.5% modulated white signal into Pin 6. (2) Adjust PIF VCO so that the AFT voltage is 2.5V. (3) Measure the amplitude of PIF det. output at Pin 47 (V _i Pol : 0), that is "VDET875". (4) Input a 38.9MHz, 90dB μ V, 87.5% modulated L-SECAM white signal into Pin 6. (5) Measure the amplitude of PIF det. output at Pin 47 (V _i Pol : 1), that is "VDETLS". (6) Input a 38.9MHz, 90dB μ V, 110% modulated white signal into Pin 6. (7) Measure the amplitude of PIF det. output at Pin 47 (V _i Pol : 0), that is "VDET110".
P2	PIF Input Sensitivity /EPIFINMIN /EPIFINMAX IF AGC Range / Δ E _{IFAGC}	RF AGC : except 0 PIF VCO : adjust Others : Preset	(1) Input a 38.9MHz, 90dB μ V, 87.5% modulated white signal into Pin 6. (2) Adjust PIF VCO so that the AFT voltage is 2.5V. (3) Decreasing the IF input level, measure the input level at which PIF det. output amplitude turns to be -3dB against VDET875 that is "EPIFINMIN". (4) Increasing the IF input level, measure the input level at which PIF det. output amplitude turns to be -0.5dB against VDET875 that is "EPIFINMAX". (5) Calculate ; " Δ E _{IFAGC} " = EPIFINMAX - EPIFINMIN
P3	PIF Det. Sync. Tip Level /VSYNC L-SECAM White Peak Level /VLSW	RF AGC : except 0 PIF VCO : adjust V _i Pol : 0 / 1 Others : Preset	(1) Input a 38.9MHz, 90dB μ V, non-modulation signal into Pin 6. (2) Adjust PIF VCO so that the AFT voltage is 2.5V. (3) Measure the DC level at Pin 47 (V _i Pol : 0), that is "VSYNC". (4) Measure the DC level at Pin 47 (V _i Pol : 1), that is "VLSW".

NOTE	ITEM / SYMBOL	BUS CONDITION	MEASUREMENT METHOD
P4	Output Level for No Input /V _{NOIF} /V _{NOIFLS}	RF AGC : except 0 V _i Pol : 0 / 1 Others : Preset	(1) Connect Pin 6 / 7 to GND. (2) Supply 3.0V to Pin 9. (3) Measure the DC level at Pin 47 (V _i Pol : 0), that is "V _{NOIF} ". (4) Measure the DC level at Pin 47 (V _i Pol : 1), that is "V _{NOIFLS} ".
P5	Differential Gain / DG Differential Phase / DP	RF AGC : except 0 PIF VCO : adjust Others : Preset	(1) Input a 38.9MHz, 90dB μ V, 87.5% modulated video signal into Pin 6. (2) Adjust PIF VCO so that the AFT voltage is 2.5V. (3) Measure "DG" & "DP" for Pin 47 output.
P6	PIF Output Freq. Response /FR _{DET}	RF AGC : except 0 PIF VCO : adjust Others : Preset	(1) Input a 38.9MHz, 90dB μ V, 87.5% modulated sweep video signal into Pin 6. (2) Adjust PIF VCO so that the AFT voltage is 2.5V. (3) Measure the Pin 9 DC level and fix it on that value. (4) For PIF det. output signal, measure the frequency at which the amplitude (Without sync) turns to be -3dB against the one for 10kHz, that is "FR _{DET} ".
P7	S / N /S / N _{PIF}	RF AGC : except 0 PIF VCO : adjust Others : Preset	(1) Input a 38.9MHz, 90dB μ V, non-modulation signal into Pin 6. (2) Adjust PIF VCO so that the AFT voltage is 2.5V. (3) Measure the amplitude of PIF det. output, that is V _N . (4) Calculate ; "S / N _{PIF} " = 20 * log (V _{DET875} / V _N)
P8	Intermodulation /I ₁₀₇	RF AGC : except 0 PIF VCO : adjust Others : Preset	(1) Input a signal composed of following 3 signals into Pin 6; 38.9MHz / 90dB μ V, 34.47MHz / 84dB μ V 33.4MHz / 84dB μ V (2) Adjust PIF VCO so that the AFT voltage is 2.5V. (3) Adjust Pin 9 voltage so that the bottom of PIF det. output is equal to V _{SYNC} . (4) Measure the 1.07MHz level against the 4.43MHz level (= 0dB), that is "I ₁₀₇ ".

NOTE	ITEM / SYMBOL	BUS CONDITION	MEASUREMENT METHOD
P9	IF AGC Voltage /VIFAGCMAX /VIFAGCMIN	RF AGC : except 0 PIF VCO : adjust Others : Preset	(1) Connect Pin 6 / 7 to GND. (2) Measure the Pin 9 voltage, that is "VIFAGCMAX". (3) Input a 38.9MHz, 107dB μ V, non-modulation signal into Pin 6. (4) Adjust PIF VCO so that the AFT voltage is 2.5V. (5) Measure the Pin 9 voltage, that is "VIFAGCMIN".
P10	RF AGC Voltage /VRFAGCMIN /VRFAGCMAX	RF AGC : adjust PIF VCO : adjust Others : Preset	(1) Input a 38.9MHz, 90dB μ V, non-modulation signal into Pin 6. (2) Adjust PIF VCO so that the AFT voltage is 2.5V. (3) Adjust RF AGC so that the Pin 9 voltage is 4.5V. (4) Increase the IF input level to 107dB μ V. (5) Measure the Pin 8 voltage, that is "VRFAGCMIN". (6) Connect Pin 6 / 7 to GND. (7) Measure the Pin 8 voltage, that is "VRFAGCMAX".
P11	RF AGC Control Range / Δ ERFAGC	RF AGC : 1 / 63 PIF VCO : adjust Others : Preset	(1) Input a 38.9MHz, 90dB μ V, non-modulation signal into Pin 6. (2) Adjust PIF VCO so that the AFT voltage is 2.5V. (3) Set RF AGC to 1. (4) Decreasing the IF input level, measure the input level at which the Pin 8 voltage is 4.5V, that is ERFAGCMIN. (5) Set RF AGC to 63. (6) Increasing the IF input level, measure the input level at which the Pin 8 voltage is 4.5V, that is ERFAGCMAX. (7) Calculate ; " Δ ERFAGC" = ERFAGCMAX - ERFAGCMIN
P12	AFT Center Voltage /VAFTCEN	RF AGC : except 0 Others : Preset	(1) Connect Pin 6 / 7 to GND. (2) Supply 3V to Pin 9. (3) Measure the Pin 4 voltage, that is "VAFTCEN".

NOTE	ITEM / SYMBOL	BUS CONDITION	MEASUREMENT METHOD
P13	AFT Voltage /V _{AFTMAX} /V _{AFTMIN}	RF AGC : except 0 PIF VCO : adjust Others : Preset	(1) Input a 38.9MHz, 90dB μ V, 87.5% modulated video signal into Pin 6. (2) Adjust PIF VCO so that the AFT voltage is 2.5V. (3) Input a 37.9MHz, 90dB μ V, 87.5% modulated video signal into Pin 6. (4) Measure the Pin 4 voltage, that is "V _{AFTMAX} " (5) Input a 39.9MHz, 90dB μ V, 87.5% modulated video signal into Pin 6. (6) Measure the Pin 4 voltage, that is "V _{AFTMIN} "
P14	AFT Sensitivity / μ AFT	RF AGC : except 0 PIF VCO : adjust Others : Preset	(1) Input a 38.9MHz, 90dB μ V, non-modulation signal into Pin 6. (2) Adjust PIF VCO so that the AFT voltage is 2.5V. (3) When changing the input frequency to ± 20 kHz, measure the change of Pin 4 voltage, that is ΔV_{AFT} . (4) Calculate ; " μ AFT" = $40 / \Delta V_{AFT}$
P15	PIF VCO Control Sensitivity / β_{IFVCO}	RF AGC : except 0 PIF VCO : adjust Others : Preset	(1) Input a 38.9MHz, 90dB μ V, non-modulation signal into Pin 6. (2) Adjust PIF VCO so that the AFT voltage is 2.5V. (3) Measure the Pin 48 voltage, that is V _{LOOP389} . (4) Input a 38.7MHz, 90dB μ V, non-modulation signal into Pin 6. (5) Measure the Pin 48 voltage, that is V _{LOOP387} . (6) Calculate ; " β_{IFVCO} " = $0.2 / (V_{LOOP387} - V_{LOOP389})$
P16	PIF VCO Pull-In Range / F _{PIFINH} / F _{PIFINL}	RF AGC : except 0 PIF VCO : adjust Others : Preset	(1) Input a 45MHz, 90dB μ V, 87.5% modulated video signal into Pin 6. (2) Adjust PIF VCO so that the AFT voltage is 2.5V. (3) Decreasing the input frequency, measure the frequency at which detected video signal appears on Pin 47, that is "F _{PIFINH} " (4) Input a 30MHz, 90dB μ V, 87.5% modulated video signal into Pin 6. (5) Increasing the input frequency, measure the frequency at which detected video signal appears on Pin 47, that is "F _{PIFINL} "

SIF & audio stage (Unless otherwise specified, $V_{CC} = 9V$ (3, 17, 28 & 52pin) / $5V$ (36 & 46pin), $T_a = 25^\circ C$)

NOTE	ITEM / SYMBOL	BUS CONDITION	MEASUREMENT METHOD
S1	FM Det. Output Level /VAUAC5P /VAUAC4P /VAUAC4N	Audio ATT : 127 Au Gain : 0 / 1 AF-G : 0 / 1 Others : Preset	(1) Input a 5.5MHz, 90dB μ V FM signal (Modulate 400Hz with 50kHz deviation) into Pin 53. (2) Measure the output amplitude at Pin 2, that is "VAUAC5P". (Au Gain : 0, AF-G : 0) (3) Input a 4.5MHz, 90dB μ V FM signal (Modulate 400Hz with 50kHz deviation) into Pin 53. (4) Measure the output amplitude at Pin 2, that is "VAUAC4P". (Au Gain : 0, AF-G : 0) (5) Input a 4.5MHz, 90dB μ V FM signal (Modulate 400Hz with 25kHz deviation) into Pin 53. (6) Measure the output amplitude at Pin 2, that is "VAUAC4N". (Au Gain : 1, AF-G : 1)
S2	Audio Distortion /DAUDIO	Audio ATT : 127 Others : Preset	(1) Input a 5.5MHz, 90dB μ V FM signal (Modulate 400Hz with 50kHz deviation) into Pin 53. (2) Measure the distortion of Pin 2 output, that is "DAUDIOP". (3) Input a 4.5MHz, 90dB μ V FM signal (Modulate 400Hz with 25kHz deviation) into Pin 53. (4) Measure the distortion of Pin 2 output, that is "DAUDION".
S3	Audio S/N /S/NSIF	Audio ATT : 127 Others : Preset	(1) Input a 5.5MHz, 90dB μ V non-modulation signal into Pin 53. (2) Measure the output amplitude at Pin 2, that is $V_{NOAUACP}$. (3) Calculate ; "S / NSIFP" = $20 * \log (VAUAC5P / V_{NOAUACP})$ (4) Input a 4.5MHz, 90dB μ V non-modulation signal into Pin 53. (5) Measure the output amplitude at Pin 2, that is $V_{NOAUACN}$. (6) Calculate ; "S / NSIFN" = $20 * \log (VAUAC5P / V_{NOAUACN})$

NOTE	ITEM / SYMBOL	BUS CONDITION	MEASUREMENT METHOD
S4	AMR /AMR	Audio ATT : 127 Others : Preset	(1) Input a 5.5MHz, 90dB μ V AM signal (Modulate 400Hz with 30%) into Pin 53. (2) Measure the output amplitude at Pin 2, that is V _{AMAU} . (3) Calculate ; "AMR" = 20* \log (V _{AUAC5P} /V _{AMAU})
S5	Limiting Sensitivity /ELIM	Audio ATT : 127 Others : Preset	(1) Input a 5.5MHz, 90dB μ V FM signal (Modulate 400Hz with 50kHz deviation) into Pin 53. (2) Decreasing the input level, measure the input level at which Pin 2 output amplitude turns to be -3dB against V _{AUAC5P} , that is "ELIM".
S6	Band Width (5.5MHz / PAL) /FAUH5P /FAUL5P	Audio ATT : 127 Others : Preset	(1) Input a 5.5MHz, 90dB μ V FM signal (Modulate 400Hz with 50kHz deviation) into Pin 53. (2) Increasing the input frequency, measure the frequency at which Pin 2 output turns to be -3dB against V _{AUAC5P} , that is "FAUH5P". (2) Decreasing the input frequency, measure the frequency at which Pin 2 output turns to be -3dB against V _{AUAC5P} , that is "FAUL5P".
S7	Band Width (4.5MHz / PAL) /FAUH4N /FAUL4N	Audio ATT : 127 Au Gain : 1 AF-G : 1 Others : Preset	(1) Input a 4.5MHz, 90dB μ V FM signal (Modulate 400Hz with 25kHz deviation) into Pin 53. (2) Increasing the input frequency, measure the frequency at which Pin 2 output turns to be -3dB against V _{AUAC4N} , that is "FAUH4N". (3) Decreasing the input frequency, measure the frequency at which Pin 2 output turns to be -3dB against V _{AUAC4N} , that is "FAUL4N".

NOTE	ITEM / SYMBOL	BUS CONDITION	MEASUREMENT METHOD
S8	Attenuator Gain /GATTMAX /GATTCEN /GATTMIN	Audio ATT : 0 / 64 / 127 Au SW : 1 Others : Preset	(1) Input a 1MHz, 500mV _{rms} signal into Pin 55. (2) Set Audio ATT to 0 / 64 / 127 and measure the Pin 2 output amplitude for each bus data, that is V _{ATTMAX} / V _{ATTCEN} / V _{ATTMIN} . (3) Calculate ; "GATTMAX" = 20*log (V _{ATTMAX} / 500) "GATTCEN" = 20*log (V _{ATTCEN} / 500) "GATTMIN" = 20*log (V _{ATTMIN} / 500)
S9	Offset between TV / Ext. /VAUOFFSET	Audio ATT : 127 Au SW : 0 / 1 Others : Preset	(1) Input a 5.5MHz, 90dB _μ V non-modulation signal into Pin 53. (2) Connect Pin 55 to GND via a 4.7 _μ F capacitor. (3) Switching Au SW to 0 / 1 and measure the change of Pin 2 DC level, that is "VAUOFFSET".
S10	DC Change by Volume /ΔV _{VOLDC}	Audio ATT : 0 / 127 Au SW : 1 Others : Preset	(1) Connect Pin 55 to GND via a 4.7 _μ F capacitor. (2) Switching Audio ATT to 0 / 127 and measure the change of Pin 2 DC level, that is "ΔV _{VOLDC} ".

Video stage (Unless otherwise specified, $V_{CC} = 9V$ (3, 17, 28 & 52pin) / $5V$ (36 & 46pin), $T_a = 25^\circ C$)

NOTE	ITEM / SYMBOL	BUS CONDITION	MEASUREMENT METHOD
V1	TV Input Dynamic Range /DR _{TV}	Video SW : 00 / 01 Others : Preset	(1) Input a white signal with sync into Pin 41 & 43. (2) Increasing the input amplitude, measure the amplitude (Include sync) at which the Pin 35 output is clipped, that is "DR _{TV} " (Video SW : 00) / "DR _{EXT} " (Video SW : 01)
	External Input Dynamic Range /DR _{EXT}		
V2	TV Mode Gain /G _{TV}	Video SW : 00 / 01 Others : Preset	(1) Input a 1V _{p-p} , white signal with sync into Pin 41 & 43. (2) Set Video SW to 00 and measure the gain between Pin 43 and Pin 35, that is "G _{TV} " (3) Set Video SW to 01 and measure the gain between Pin 41 and Pin 35, that is "G _{EXT} "
	Ext. Mode Gain /G _{EXT}		
V3	AV SW Cross-Talk /CT _{SWTE} /CT _{SWET}	Video SW : 00 / 01 Others : Preset	(1) Input a PAL red signal with sync into Pin 43 and connect Pin 41 to GND via a 1 μ F capacitor. (2) Set Video SW 01, measure the amplitude of 4.43MHz signal at Pin 35 and calculate the cross-talk, that is "CT _{SWTE} ". (3) Input a red signal into Pin 41 and connect Pin 43 to GND via a 1 μ F capacitor. (4) Set Video SW 00, measure the amplitude of 4.43MHz signal at Pin 35 and calculate the cross-talk, that is "CT _{SWET} ".
V4	Y Input Dynamic Range /DR _Y	Uni-Color : 32 Brightness : 0 Color : 0 Others : Preset	(1) Input a white signal with sync into Pin 43 & 39. (2) Increasing the Pin 39 input amplitude, measure the amplitude (include sync) at which the Pin 18 output is clipped, that is "DR _Y ".
V5	Y Input Pedestal Clamp Voltage /V _{YCLP}	All : Preset	(1) Input a composite sync signal into Pin 43. (2) Connect Pin 39 to GND via a 1 μ F capacitor. (3) Measure the DC Voltage at Pin 39, that is "V _{YCLP} ".
V6	Y Delay Time /t _{YDEL}	Uni-Color : 63 Color : 0 Others : Preset	(1) Input a 2T pulse with sync into Pin 43 & 39. (2) Observe the Pin 18 output, measure the delay time between Pin 39 and Pin 18, that is "t _{YDEL} ".

NOTE	ITEM / SYMBOL	BUS CONDITION	MEASUREMENT METHOD
V7	Brightness Characteristics /V _{BRTMAX} /V _{BRTCEN} /V _{BRTMIN} Brightness Data Sensitivity /ΔV _{BRT}	Brightness : 0 / 64 / 127 Color : 0 Others : Preset	(1) Input a 0IRE black signal with sync into Pin 43 & 39. (2) Measure the DC level of picture period at Pin 18 for Brightness : 127 / 64 / 0, that is "V _{BRTMAX} " / "V _{BRTCEN} " / "V _{BRTMIN} ". (3) Calculate ; "ΔV _{BRT} " = (V _{BRTMAX} - V _{BRTMIN}) / 127
V8	Uni-Color Characteristics for Y /G _{UCYMAX} /G _{UCYCEN} /G _{UCYMIN}	Uni-Color : 0 / 32 / 63 Color : 0 Others : Preset	(1) Input a 50IRE (0.357V) white signal with sync into Pin 43 & 39. (2) Measure the output picture amplitude at Pin 18 for Uni-Color 63 / 32 / 0, that is V _{UCYMAX} / V _{UCYCEN} / V _{UCYMIN} . (3) Calculate ; "G _{UCYMAX} " = 20 * log (V _{UCYMAX} / 0.357) "G _{UCYCEN} " = 20 * log (V _{UCYCEN} / 0.357) "G _{UCYMIN} " = 20 * log (V _{UCYMIN} / 0.357)
V9	Sub-Contrast Characteristics /G _{SCONMAX} /G _{SCONMIN}	Sub-Contrast : 0 / 8 / 15 Uni-Color : 63 Color : 0 Others : Preset	(1) Input a 50IRE white signal with sync into Pin 43 & 39. (2) Measure the output picture amplitude at Pin 18 for Sub-Contrast 15 / 8 / 0, that is V _{SCONMAX} / V _{SCONCEN} / V _{SCONMIN} . (3) Calculate ; "G _{SCONMAX} " = 20 * log (V _{SCONMAX} / V _{SCONCEN}) "G _{SCONMIN} " = 20 * log (V _{SCONMIN} / V _{SCONCEN})
V10	Sharpness Peaking Frequency /F _{SHP}	Sharpness : 63 Uni-Color : 63 Color : 0 Others : Preset	(1) Input a 0.5V _{p-p} sweep signal with sync into Pin 43 & 39. (2) Measure the frequency at which the Pin 18 output amplitude is Max., that is "F _{SHP} ".
V11	Sharpness Control Characteristics /G _{SHMAX} /G _{SHCEN} /G _{SHMIN}	Sharpness : 0 / 32 / 63 Uni-Color : 63 Color : 0 Others : Preset	(1) Input a 0.5V _{p-p} sweep signal with sync into Pin 43 & 39. (2) Measure the output picture amplitude for 100kHz at Pin 18, that is V _{SH100k} . (3) Measure the output picture amplitude for F _{SHP} when Sharpness is max., center and min., that is V _{SHMAX} , V _{SHCEN} and V _{SHMIN} . (4) Calculate ; "G _{SHMAX} " = 20 * log (V _{SHMAX} / V _{SH100k}) "G _{SHCEN} " = 20 * log (V _{SHCEN} / V _{SH100k}) "G _{SHMIN} " = 20 * log (V _{SHMIN} / V _{SH100k})

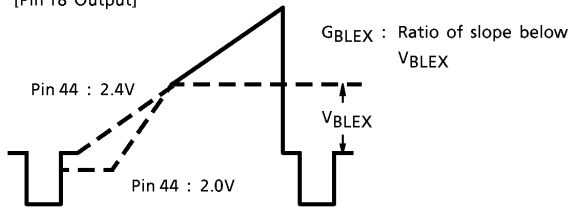
NOTE	ITEM / SYMBOL	BUS CONDITION	MEASUREMENT METHOD
V12	Y Frequency Response /FR _Y	Uni-Color : 63 Sharpness : Adjust Color : 0 Others : Preset	(1) Input a 0.5V _{p-p} sweep signal with sync into Pin 43 & 39. (2) Adjust Sharpness so that the output amplitude for F _{SH} 100k equals V _{SH} 100k. (3) Measure the frequency at which the output amplitude is 3dB down against V _{SH} 100k, which is "FR _Y ".
V13	Black Expansion Start Point /V _{BLEX}	Uni-Color : 63 Color : 0 Others : Preset	(1) Input a 100IRE ramp signal with sync into Pin 43 & 39. (2) Supply 2.4V / 2.0V to Pin 44 and observe the Pin 18 output. (3) Measure "V _{BLEX} " and "G _{BLEX} ". [Pin 18 Output] 
	Black Expansion AMP Gain /G _{BLEX}		
V14	Black Peak Detection Level /ΔV _{BLPD}	Others : Preset	(1) Input a composite sync signal into Pin 43. (2) Increasing the Pin 39 DC level, measure the level at which the Pin 44 voltage drops down, that is V _{BLPD} . (3) Calculate ; "ΔV _{BLPD} " = V _{BLPD} - V ₃₉
V15	WPS Level /V _{WPS}	Uni-Color : 63 Brightness : 127 Color : 0 Others : Preset	(1) Input a 100IRE ramp signal with sync into Pin 43 & 39. (2) Measure the amplitude from cut-off level to peak (At which output signal is clipped), that is "V _{WPS} ".
V16	Chroma Trap Gain /G _{TRAP} 358, G _{TRAP} 443	C-Trap : 0 / 1 Uni-Color : 63 Color : 0 Others : Preset	(1) Input a 0.5V _{p-p} , 3.58MHz signal with sync into Pin 43 & 39. (2) Measure the 3.58MHz amplitude at Pin 18 for Chroma Trap : 1 / 0, that is V _{TRAPON} / V _{TRAPOFF} . (3) Calculate ; "G _{TRAP358} " = 20 * log (V _{TRAPON} / V _{TRAPOFF}) (4) Input a 0.5V _{p-p} , 4.43MHz signal with sync into Pin 43 & 39. (5) Measure the 4.43MHz amplitude at Pin 18 for Chroma Trap : 1 / 0, that is V _{TRAPON} / V _{TRAPOFF} . (6) Calculate ; "G _{TRAP443} " = 20 * log (V _{TRAPON} / V _{TRAPOFF})

NOTE	ITEM / SYMBOL	BUS CONDITION	MEASUREMENT METHOD
V17	Half Tone Characteristics for Y /GHTY	Half Tone : 0 / 1 Uni-Color : 63 Color : 0 Others : Preset	(1) Input a 100IRE white signal with sync into Pin 43 & 39. (2) Measure the output picture amplitude at Pin 18 for Half Tone : 1 / 0, that is V_{HTYON} / V_{HTYOFF} . (3) Calculate ; "GHTY" = $20 * \log (V_{HTYON} / V_{HTYOFF})$

Chrome stage (Unless otherwise specified, $V_{CC} = 9V$ (3, 17, 28 & 52pin) / $5V$ (36 & 46pin), $T_a = 25^{\circ}C$)

NOTE	ITEM / SYMBOL	BUS CONDITION	MEASUREMENT METHOD
C1	ACC Characteristics /V _{ACCH} /V _{ACCL}	Mute : 01 Uni-Color : 63 Others : Preset	(1) Input a 4.43MHz PAL rainbow color-bar (300mV _{p-p} , burst : chroma = 1 : 1) with sync into Pin 43. (2) Changing the amplitude of burst and chroma, measure the input amplitude at which Pin 20 output amplitude is +1dB / -1dB against the one for 300mV _{p-p} input, that is "V _{ACCH} " / "V _{ACCL} ".
C2	TOF Characteristics (4.43MHz) /F _{0T443} /Q _{T443} BPF Characteristics (4.43MHz) /F _{0B443} /Q _{B443} TOF Characteristics (3.58MHz) /F _{0T358} /Q _{T358} BPF Characteristics (3.58MHz) /F _{0B358} /Q _{B358}	TEST : 01000111 C-BPF : 0 / 1 Color : 010 / 101 System : 010 / 101 Others : Preset	(1) Set C-BPF to 1 and Color System to 010. (2) Input a sweep signal into Pin 43. (3) Observe the frequency response at Pin 18 and measure the Peaking Frequency / Q of chroma filter, that is "F _{0T443} " / "Q _{T443} ". (4) Set C-BPF to 0 and Color System to 010 and repeat (2) & (3), that is "F _{0B443} " / "Q _{B443} ". (5) Set C-BPF to 1 and Color System to 101 and repeat (2) & (3), that is "F _{0T358} " / "Q _{T358} ". (6) Set C-BPF to 0 and Color System to 101 and repeat (2) & (3), that is "F _{0B358} " / "Q _{B358} ".
C3	C Delay Time /t _{CDEL} Delay Time Difference between Y / C /Δt _{Y / C}	Mute : 01 Uni-Color : 63 Others : Preset	(1) Input a 4.43MHz, PAL rainbow color-bar (300mV _{p-p} , burst : chroma = 1 : 1) with sync into Pin 43. (2) Observe the Pin 18 output, measure the delay time between Pin 43 and Pin 18, that is "t _{CDEL} ". (3) Calculate ; "Δt _{Y / C} " = t _{YDEL} - t _{CDEL}
C4	Color Characteristics /G _{COLMAX} /G _{COLMIN}	Color : 0 / 64 / 127 Mute : 01 Uni-Color : 63 Others : Preset	(1) Input a 4.43MHz PAL rainbow color-bar (300mV _{p-p} , burst : chroma = 1 : 1) with sync into Pin 43. (2) Measure the Pin 18 amplitude for Color 127 / 64 / 0, that is V _{COLMAX} / V _{COLCEN} / V _{COLMIN} . (3) Calculate ; "G _{COLMAX} " = 20 * log (V _{COLMAX} / V _{COLCEN}) "G _{COLMIN} " = 20 * log (V _{COLMIN} / V _{COLCEN})

NOTE	ITEM / SYMBOL	BUS CONDITION	MEASUREMENT METHOD
C5	Uni-Color Characteristics for C / GUCC	Uni-Color : 0 / 63 Mute : 01 Others : Preset	(1) Input a 4.43MHz, PAL rainbow color-bar (300mV _{p-p} , burst : chroma = 1 : 1) with sync into Pin 43. (2) Measure the Pin 18 amplitude for Uni-Color 63 / 0, that is V _{UCCMAX} and V _{UCCMIN} . (3) Calculate ; "GUCC" = 20 * log (V _{UCCMIN} / V _{UCCMAX})
C6	Tint Characteristics (3.58MHz) / Δ θ _{358MAX} / Δ θ _{358MIN}	Tint : 0 / 64 / 127 Mute : 01 Uni-Color : 63 Others : Preset	(1) Input a 3.58MHz NTSC rainbow color-bar (286mV _{p-p} , burst : chroma = 1 : 1) with sync into Pin 43. (2) Set Tint to 64 and adjust the burst phase so that the 6th bar of Pin 20 output is maximum, that is θ _{358CEN} . (3) Change Tint to 127 / 0 and adjust the burst phase so that the 6th bar of Pin 20 output is maximum, that is θ _{358MAX} / θ _{358MIN} . (4) Calculate ; "Δ θ _{358MAX} " = - (θ _{358MAX} - θ _{358CEN}) "Δ θ _{358MIN} " = - (θ _{358MIN} - θ _{358CEN})
	Tint Characteristics (4.43MHz) / Δ θ _{443MAX} / Δ θ _{443MIN}		(5) Input a 4.43MHz NTSC rainbow color-bar (286mV _{p-p} , burst : chroma = 1 : 1) with sync into Pin 43 and repeat (2) & (3), that is θ _{443CEN} / θ _{443MAX} / θ _{443MIN} . (6) Calculate ; "Δ θ _{443MAX} " = - (θ _{443MAX} - θ _{443CEN}) "Δ θ _{443MIN} " = - (θ _{443MIN} - θ _{443CEN})
C7	Relative Amplitude (PAL) / V _{PR / B} / V _{PG / B}	Mute : 01 Uni-Color : 63 Others : Preset	(1) Input a 4.43MHz, PAL rainbow color-bar (300mV _{p-p} , burst : chroma = 1 : 1) with sync into Pin 43. (2) Measure the amplitude of Pin 18 / 19 / 20 output, that is "V _{PROUT} " / "V _{PGOUT} " / "V _{PBOUT} ". (3) Calculate ; "V _{PR / B} " = V _{PROUT} / V _{PBOUT} "V _{PG / B} " = V _{PGOUT} / V _{PBOUT}
	Relative Amplitude (NTSC) / V _{NR / B} / V _{NG / B}		(4) Input a 3.58MHz NTSC rainbow color-bar (286mV _{p-p} , burst : chroma = 1 : 1) with sync into Pin 43, then repeat (2), that is V _{NROUT} / V _{NGOUT} / V _{NBOUT} . (5) Calculate ; "V _{NR / B} " = V _{NROUT} / V _{NBOUT} "V _{NG / B} " = V _{NGOUT} / V _{NBOUT}

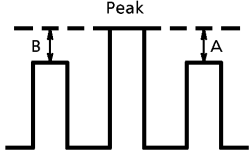
NOTE	ITEM / SYMBOL	BUS CONDITION	MEASUREMENT METHOD
C8	Relative Phase (PAL) / θ_{PR-B} / θ_{PG-B}	Mute : 01 Uni-Color : 63 Others : Preset	(1) Input a 4.43MHz PAL rainbow color-bar (300mV _{p-p} , burst : chroma = 1 : 1) with sync into Pin 43. (2) Observe the Pin 18 / 19 / 20 output, measure the R / G / B modulation angle (θ_{PR} / θ_{PG} / θ_{PB}) according following figure and equality. $\theta_{p*} = \theta_{0*} - \left\{ \tan^{-1} \left(\frac{1}{\frac{2A}{B} + \sqrt{3}} \right) - 15 \right\}$  <p>For θ_{PR} ; Peak : 3rd bar, $\theta_{0R} = 90$ For θ_{PG} ; Peak (Negative) : 4th bar, $\theta_{0G} = 240$ For θ_{PB} ; Peak : 6th bar, $\theta_{0B} = 0$</p> (3) Calculate ; $\theta_{PR-B} = \theta_{PR} - \theta_{PB}$ $\theta_{PG-B} = \theta_{PG} - \theta_{PB}$
	Relative Phase (NTSC) / θ_{NR-B} / θ_{NG-B}		(4) Input a 3.58MHz NTSC rainbow color-bar (286mV _{p-p} , burst : chroma = 1 : 1) with sync into Pin 43, then repeat (2), that is θ_{NR} / θ_{NG} / θ_{NB} . (5) Calculate ; $\theta_{NR-B} = \theta_{NR} - \theta_{NB}$ $\theta_{NG-B} = \theta_{NG} - \theta_{NB}$

NOTE	ITEM / SYMBOL	BUS CONDITION	MEASUREMENT METHOD
C9	APC Pull-In Range (4.43MHz) / ΔF_{4APCP+} / ΔF_{4APCP-}	Color System : 010 / 101 Others : Preset	(1) Input a 4.43MHz PAL rainbow color-bar (300mV _{p-p} , burst : chroma = 1 : 1) with sync into Pin 43. (2) Set Color System to 010 (443PAL). (3) For higher frequency than 4.43MHz, measure the burst frequency at which Pin 29 DC level changes from low to high / from high to low, that is F_{4APCP+} / F_{4APCH+} . (4) For lower frequency than 4.43MHz, repeat (2), that is F_{4APCP-} / F_{4APCH-} . (5) Calculate ; $\Delta F_{4APCP+} = F_{4APCP+} - 4433619$ $\Delta F_{4APCP-} = 4433619 - F_{4APCP-}$ $\Delta F_{4APCH+} = F_{4APCH+} - 4433619$ $\Delta F_{4APCH-} = 4433619 - F_{4APCH-}$ (6) Input a 3.58MHz NTSC rainbow color-bar (286mV _{p-p} , burst : chroma = 1 : 1) with sync into Pin 43. (7) Set Color System to 101 (358NTSC). (8) For higher frequency than 3.58MHz, repeat (2), that is F_{3APCP+} / F_{3APCH+} . (9) For lower frequency than 3.58MHz, repeat (2), that is F_{3APCP-} / F_{3APCH-} . (10) Calculate ; $\Delta F_{3APCP+} = F_{3APCP+} - 3579545$ $\Delta F_{3APCP-} = 3579545 - F_{3APCP-}$ $\Delta F_{3APCH+} = F_{3APCH+} - 3579545$ $\Delta F_{3APCH-} = 3579545 - F_{3APCH-}$
	APC Hold Range (4.43MHz) / ΔF_{4APCH+} / ΔF_{4APCH-}		
	APC Pull-In Range (3.58MHz) / ΔF_{3APCP+} / ΔF_{3APCP-}		
	APC Hold Range (3.58MHz) / ΔF_{3APCH+} / ΔF_{3APCH-}		

NOTE	ITEM / SYMBOL	BUS CONDITION	MEASUREMENT METHOD
C10	APC Control Sensitivity (4.43MHz) / β_{443}	Color System : 010 / 101 Others : Preset	(1) Connect Pin 43 to GND via a 1 μ F capacitor. (2) Set Color System to 010 (443PAL). (3) Adjust Pin 10 voltage so that the Pin 29 output frequency is 4.433619MHz, that is $V_{4APCCEN}$. (4) Measure the Pin 29 output frequency when Pin 10 voltage is $V_{4APCCEN} + 100mV / V_{4APCCEN} - 100mV$, that is F_{4APC+} / F_{4APC-} . (5) Calculate ; $"\beta_{443}" = (F_{4APC+} - F_{4APC-}) / 200$ (6) Set Color System to 101 (358NTSC). (7) Adjust Pin 10 voltage so that the Pin 29 output frequency is 3.579545MHz, that is $V_{3APCCEN}$. (8) Measure the Pin 29 output frequency when Pin 10 voltage is $V_{3APCCEN} + 100mV / V_{3APCCEN} - 100mV$, that is F_{3APC+} / F_{3APC-} . (9) Calculate ; $"\beta_{358}" = (F_{3APC+} - F_{3APC-}) / 200$
	APC Control Sensitivity (3.58MHz) / β_{358}		
C11	PAL ID Sensitivity (Normal Mode) / $V_{PALIDON}$ / $V_{PALIDOFF}$	ID SW : 0 / 1 Color System : 010 / 101 Mute : 01 Uni-Color : 63 Others : Preset	(1) Set ID SW to 0. (2) Set Color System to 010 (443PAL). (3) Input a 4.43MHz PAL rainbow color-bar (300mV _{p-p} , burst : chroma = 1 : 1) with sync into Pin 43. (4) Measure the burst amplitude at which Pin 29 DC level changes from low to high / from high to low, that is " $V_{PALIDON}$ " / " $V_{PALIDOFF}$ ". (5) Set Color System to 101 (358NTSC). (6) Input a 3.58MHz NTSC rainbow color-bar (286mV _{p-p} , burst : chroma = 1 : 1) with sync into Pin 43, and repeat (3), that is " V_{NTIDON} " / " $V_{NTIDOFF}$ ". (7) Set ID SW to 1, repeat (2) ~ (6), that is " $V_{PALIDLON}$ ", " $V_{PALIDLOFF}$ ", " $V_{NTIDLON}$ ", " $V_{NTIDLOFF}$ ".
	PAL ID Sensitivity (Low Mode) / $V_{PALIDLON}$ / $V_{PALIDLOFF}$		
	NTSC ID Sensitivity (Normal Mode) / V_{NTIDON} / $V_{NTIDOFF}$		
	NTSC ID Sensitivity (Low Mode) / $V_{NTIDLON}$ / $V_{NTIDLOFF}$		

NOTE	ITEM / SYMBOL	BUS CONDITION	MEASUREMENT METHOD
C12	ID Output Level /VIDH /VIDL	All : Preset	(1) Input a 4.43MHz PAL color-bar (300mV _{p-p} , burst : chroma = 1 : 1) with sync into Pin 43. (2) Measure the center DC level of Pin 29 output, that is "VIDH". (3) Connect Pin 43 to GND via a 1μF capacitor and repeat (2), that is "VIDL".
C13	SECAM ID Det. Current /ISECAM	All : Preset	(1) Input a 4.43MHz NTSC color-bar with sync into Pin 43. (2) Connect Pin 37 / 38 to GND via a 0.1μF capacitor. (3) Pulling the current out of Pin 29, measure the current at which a demodulated output signal disappears at Pin 20, that is "ISECAM".
C14	fsc Continuous Wave Output Level /VCW	CW SW : 1 Others : Preset	Measure the amplitude of Pin 29 output, that is "VCW".
C15	Sub-Carrier Remain on RGB Output /VSCR /VSCG /VSCB	Mute : 01 Uni-Color : 63 Others : Preset	(1) Input a 4.43MHz PAL rainbow color-bar (300mV _{p-p} , burst : chroma = 1 : 1) with sync into Pin 43. (2) Measure the amplitude of 4.43MHz signal at Pin 18 / 19 / 20, that is "VSCR" / "VSCG" / "VSCB".
C16	Half Tone Characteristics for C /GHTC	Half Tone : 1 Mute : 01 Uni-Color : 63 Others : Preset	(1) Input a 4.43MHz PAL rainbow color-bar (300mV _{p-p} , burst : chroma = 1 : 1) with sync into Pin 43. (2) Set Half Tone to 1 and measure the amplitude of Pin 20 output, that is VPBHTC. (3) Calculate ; "GHTC" = 20* \log (VPBHTC / VPBOUT)

Text stage (Unless otherwise specified, $V_{CC}=9V$ (3, 17, 28 & 52pin) / $5V$ (36 & 46pin), $T_a = 25^{\circ}C$)

NOTE	ITEM / SYMBOL	BUS CONDITION	MEASUREMENT METHOD
T1	V-BLK Pulse Output Level / V_{VBLK} H-BLK Pulse Output Level / V_{HBLK}	All : Preset	(1) Input a composite sync signal into Pin 43. (2) Measure the DC level of V / H blanking period at Pin 20, that is " V_{VBLK} " / " V_{HBLK} ".
T2	RGB Output Black Level (0IRE DC) / V_{BLACK}	Color : 0 Others : Preset	(1) Input a 0IRE Y signal with sync into Pin 43 & 39. (2) Measure the DC level of picture period at Pin 20, that is " V_{BLACK} ".
T3	RGB Output White Level (100IRE AC) / V_{WHITE}	Uni-Color : 63 Color : 0 Others : Preset	(1) Input a 100IRE Y signal with sync into Pin 43 & 39. (2) Measure the amplitude from 0 to 100IRE at Pin 20, that is " V_{WHITE} ".
T4	Cut-Off Voltage Variable Range / ΔV_{CUT+} / ΔV_{CUT-}	B Cut Off : 0 / 255 Color : 0 Others : Preset	(1) Input a 0IRE Y signal with sync into Pin 43 & 39. (2) Measure the DC level of picture period at Pin 20 for B Cut-off : 255 / 0, that is V_{CUTMAX} / V_{CUTMIN} . (3) Calculate ; " ΔV_{CUT+} " = $V_{CUTMAX} - V_{BLACK}$ " ΔV_{CUT-} " = $V_{CUTMIN} - V_{BLACK}$
T5	Drive Control Variable Range / G_{DR+} / G_{DR-}	B Drive : 0 / 127 Uni-Color : 63 Color : 0 Others : Preset	(1) Input a 100IRE Y signal with sync into Pin 43 & 39. (2) Measure the amplitude from 0 to 100IRE at Pin20 for B drive 127 / 0, that is V_{DRMAX} / V_{DRMIN} . (3) Calculate ; " G_{DR+} " = $20 * \log (V_{DRMAX} / V_{WHITE})$ " G_{DR-} " = $20 * \log (V_{DRMIN} / V_{WHITE})$
T6	ABCL Control Voltage Range / V_{ABCLH} / V_{ABCLL} ACL Gain / G_{ACL}	ABL Gain : 11 Uni-Color : 63 Color : 0 Others : Preset	(1) Input a 100IRE Y signal with sync into Pin 43 & 39. (2) Decreasing the Pin 21 voltage, measure the voltage at which Pin 20 output begins / stops decreasing, that is " V_{ABCLH} " / " V_{ABCLL} ". (3) Measure the minimum amplitude of Pin 20 output, that is V_{ACLMIN} . (4) Calculate ; " G_{ACL} " = $20 * \log (V_{ACLMIN} / V_{WHITE})$

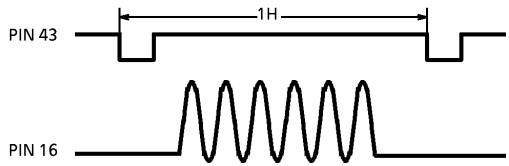
NOTE	ITEM / SYMBOL	BUS CONDITION	MEASUREMENT METHOD
T7	ABL Start Point /VABLP0 /VABLP1 /VABLP2 /VABLP3	ABL Start Point : 00/01/10/11 ABL Gain : 11 Uni-Color : 63 Color : 0 Others : Preset	(1) Input a 0IRE Y signal with sync into Pin 43 & 39. (2) For ABL Point 00/01/10/11, decreasing the Pin 21 voltage, measure the voltage at which Pin 20 output begins decreasing, that is VABL1/VABL2/VABL3/VABL4. (3) Calculate ; "VABLP0" = VABL1 - VABCLH "VABLP1" = VABL2 - VABCLH "VABLP2" = VABL3 - VABCLH "VABLP3" = VABL4 - VABCLH
T8	ABL Gain /VABLG0 /VABLG1 /VABLG2 /VABLG3	ABL Gain : 00/01/10/11 Uni-Color : 63 Color : 0 Others : Preset	(1) Input a 0IRE Y signal with sync into Pin 43 & 39. (2) For ABL Gain 00/01/10/11, measure the DC level of picture period at Pin 20 when Pin 21 voltage is VABCLL, that is VABL5/VABL6/VABL7/VABL8. (3) Calculate ; "VABLG0" = VABL5 - VBLACK "VABLG1" = VABL6 - VBLACK "VABLG2" = VABL7 - VBLACK "VABLG3" = VABL8 - VBLACK
T9	Analog RGB Dynamic Range /DRTX	RGB Contrast : 32 Others : Preset	(1) Input a composite sync signal into Pin 43. (2) Supply 2V to Pin 13. (3) Input a signal of following figure into Pin 16.  <p>The diagram shows two waveforms. The top waveform, labeled PIN 43, is a square pulse with a duration of 1H. The bottom waveform, labeled PIN 16, is a series of five pulses that occur during the 1H pulse on PIN 43.</p> (4) Increasing the amplitude of Pin 16 input, measure the amplitude at which the Pin 20 amplitude stops increasing, that is "DRTX".

NOTE	ITEM / SYMBOL	BUS CONDITION	MEASUREMENT METHOD
T10	Analog RGB Contrast Control Characteristic / GTXCMAX / GTXCCEN / GTXCMIN	RGB Contrast : 32 Others : Preset	(1) Input a composite sync signal into Pin 43. (2) Supply 2V to Pin 13. (3) Input a signal of NOTE : T _g figure into Pin 16. (4) For RGB Contrast 63 / 32 / 0, measure the amplitude of Pin 20 output, that is V _{TXCMAX} / V _{TXCCEN} / V _{TXCMIN} . (5) Calculate ; "GTXCMAX" = 20 * log (V _{TXCMAX} / 0.2) "GTXCCEN" = 20 * log (V _{TXCCEN} / 0.2) "GTXCMIN" = 20 * log (V _{TXCMIN} / 0.2)
T11	Analog RGB Brightness Control Characteristic / VTXBRMAX / VTXBRCEN / VTXBRMIN	Brightness : 0 / 64 / 127 Others : Preset	(1) Supply 2V to Pin 13. (2) Connect Pin 16 to GND via a 0.1 μF capacitor. (3) For Brightness 127 / 64 / 0, measure the DC level of picture period at Pin 20, that is "VTXBRMAX" / "VTXBRCEN" / "VTXBRMIN".
T12	Analog RGB Mode Switching Level / V _{YS}	RGB Contrast : 32 Others : Preset	(1) Input a composite sync signal into Pin 43. (2) Input a signal of NOTE : T _g figure into Pin 16. (3) Increasing the Pin 13 voltage, measure the voltage at which the signal inputted into Pin 16 appears at Pin 20, that is "V _{YS} ".
T13	Analog RGB Mode Transfer Characteristic / τ _{RYs} / t _{PRys} / τ _{FYs} / t _{PFys}	All : Preset	(1) Input a 50IRE Y signal with sync into Pin 43 & 39. (2) Connect Pin 16 to GND via a 0.1 μF capacitor. (3) According to following figure, measure the Analog RGB Mode Transfer Characteristic <div style="text-align: center;"> </div>

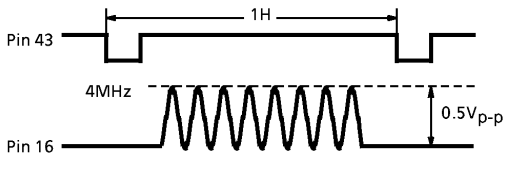
NOTE	ITEM / SYMBOL	BUS CONDITION	MEASUREMENT METHOD
T14	Cross Talk from Analog RGB to TV / CT _{TX-TV}	Uni-Color : 63 RGB Contrast : 63 Others : Preset	<p>(1) Input a composite sync signal into Pin 43. (2) Connect Pin 39 to GND via a 1μF capacitor. (3) Input a signal of following figure into Pin 16.</p>  <p>(4) Measure the amplitude of 4MHz signal at Pin 20, that is V_{TX-TV}. (5) Calculate ; "CT_{TX-TV}" = 20 * log (V_{TX-TV} / 0.5)</p>
T15	Cross Talk from TV to Analog RGB / CT _{TV-TX}	Uni-Color : 63 RGB Contrast : 63 Others : Preset	<p>(1) Input a 4MHz, 0.5V_{p-p} Y signal with sync into Pin 43 & 39. (2) Connect Pin 16 to GND via a 0.1μF capacitor. (3) Supply 2V to Pin 13. (4) Measure the amplitude of 4MHz signal at Pin 20, that is V_{TV-TX}. (5) Calculate ; "CT_{TV-TX}" = 20 * log (V_{TV-TX} / 0.5)</p>
T20	SECAM Black Level Adj. Characteristics / V _{SECBMAX} / V _{SECRMAX} / V _{SECBMIN} / V _{SECRMIN} SECAM Black Level Adj. Data Sensitivity / Δ V _{SECB} / Δ V _{SECR}	Color System : 111 B-Y Black Adj : 0 / 8 / 15 R-Y Black Adj : 0 / 8 / 15	<p>(1) Connect Pin 29 to GND via a 5.1kΩ resistor. (2) For B-Y / R-Y Black Adj. : 8, measure the DC level of picture period at Pin 20 / 18, that is V_{SECB}CEN / V_{SECR}CEN. (3) For B-Y Black Adj. : 0 / 15, measure the DC level change of picture period against V_{SECB}CEN at Pin 20, that is "V_{SECB}MIN" / "V_{SECB}MAX". (4) For R-Y Black Adj. : 0 / 15, measure the DC level change of picture period against V_{SECR}CEN at Pin 18, that is "V_{SECR}MIN" / "V_{SECR}MAX". (5) Calculate ; "ΔV_{SECB}" = (V_{SECB}MAX - V_{SECB}MIN) / 16 "ΔV_{SECR}" = (V_{SECR}MAX - V_{SECR}MIN) / 16</p>

DEF stage (Unless otherwise specified, $V_{CC} = 9V$ (3, 17, 28 & 52pin) / $5V$ (36 & 46pin), $T_a = 25^{\circ}C$)

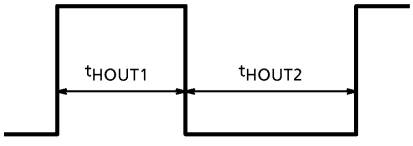
NOTE	ITEM / SYMBOL	BUS CONDITION	MEASUREMENT METHOD
D1	AFC Inactive Period / $T_{50AFCOFF}$ / $T_{60AFCOFF}$	All : Preset	(1) Input a 50Hz / 60Hz composite sync signal into Pin 43. (2) Measure " $T_{50AFCOFF}$ " / " $T_{60AFCOFF}$ " at Pin 40. (cf. Fig.D1)
D2	H-OUT Start Voltage / V_{HON}	All : Preset	(1) Let Pin 3 / 17 / 52 / 36 / 46 be open. (2) Increasing Pin 28 voltage, measure the voltage at which H OUT pulse appears at Pin 32, that is " V_{HON} ".
D3	H-OUT Pulse Duty / W_{HOUT}	All : Preset	(1) Measure t_{HOUT1} & t_{HOUT2} at Pin 32.  (2) Calculate ; $W_{HOUT} = t_{HOUT1} / (t_{HOUT1} + t_{HOUT2}) * 100$
D4	H-OUT Freq. on AFC Stop Mode / $F_{HAFCOFF}$	AFC Gain : 11 Others : Preset	(1) Input a 50Hz composite sync signal into Pin 43. (2) Measure the H OUT frequency at Pin 32, that is " $F_{HAFCOFF}$ ".
D5	Horizontal Free-Run Frequency / F_{H50FR} / F_{H60FR}	V-Freq : 10 / 11 Others : Preset	For V-Freq 10 / 11, measure the H OUT frequency at Pin 32, that is " F_{H50FR} " / " F_{H60FR} ".
D6	Horizontal Freq. Variable Range / F_{HMAX} / F_{HMIN}	All : Preset	(1) Connect Pin 40 to V_{CC} via a $10k\Omega$ and measure the H OUT frequency at Pin 32, that is " F_{HMAX} ". (2) Connect Pin 40 to GND via a $68k\Omega$ and measure the H OUT frequency at Pin 32, that is " F_{HMIN} ".
D7	Horizontal Freq. Control Sensitivity / β_{HAFC}	All : Preset	(1) Measure the Pin 40 voltage at which H OUT frequency is 15.734kHz, that is V_{H15734} . (2) Measure the H OUT frequency when Pin 40 voltage is $V_{H15734} + 50mV$ / $V_{H15734} - 50mV$, that is F_{HHIGH} / F_{HLOW} . (3) Calculate ; $\beta_{HAFC} = (F_{HHIGH} - F_{HLOW}) / 100$

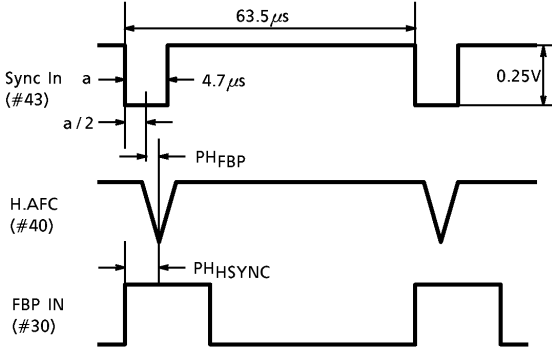
NOTE	ITEM / SYMBOL	BUS CONDITION	MEASUREMENT METHOD
D8	Horizontal Pull-in Range / ΔF_{HPH} / ΔF_{HPL}	All : Preset	(1) Input a composite sync signal into Pin 43. (2) Decreasing the horizontal frequency from 17kHz, measure the frequency at which H OUT synchronized with Sync Out (Pin 31), that is F_{HPH} . (3) Increasing the horizontal frequency from 14kHz, measure the frequency at which H OUT synchronized with Sync Out (Pin 31), that is F_{HPL} . (4) Calculate ; $\Delta F_{HPH} = F_{HPH} - 15734$ $\Delta F_{HPL} = 15625 - F_{HPL}$
D9	H-OUT Voltage / V_{HOUTH} / V_{HOUTL}	All : Preset	(1) Measure the high level of H OUT at Pin 32, that is " V_{HOUTH} ". (2) Measure the Low level of H OUT at Pin 32, that is " V_{HOUTL} ".
D10	Horizontal Freq. Dependence on V_{CC} / ΔF_{HVCC}	All : Preset	(1) Measure the H OUT frequency when H V_{CC} is 8.5V / 9.5V, that is F_{HVCCH} / F_{HVCCL} . (2) Calculate ; $\Delta F_{HVCC} = (F_{HVCCH} - F_{HVCCL}) / 1$
D11	FBP Phase / PH_{FBP} H-Sync. Phase / PH_{HSYNC}	All : Preset	(1) Input a composite sync signal into Pin 43. (2) According to the following figure, measure " PH_{FBP} " & " PH_{HSYNC} ". 

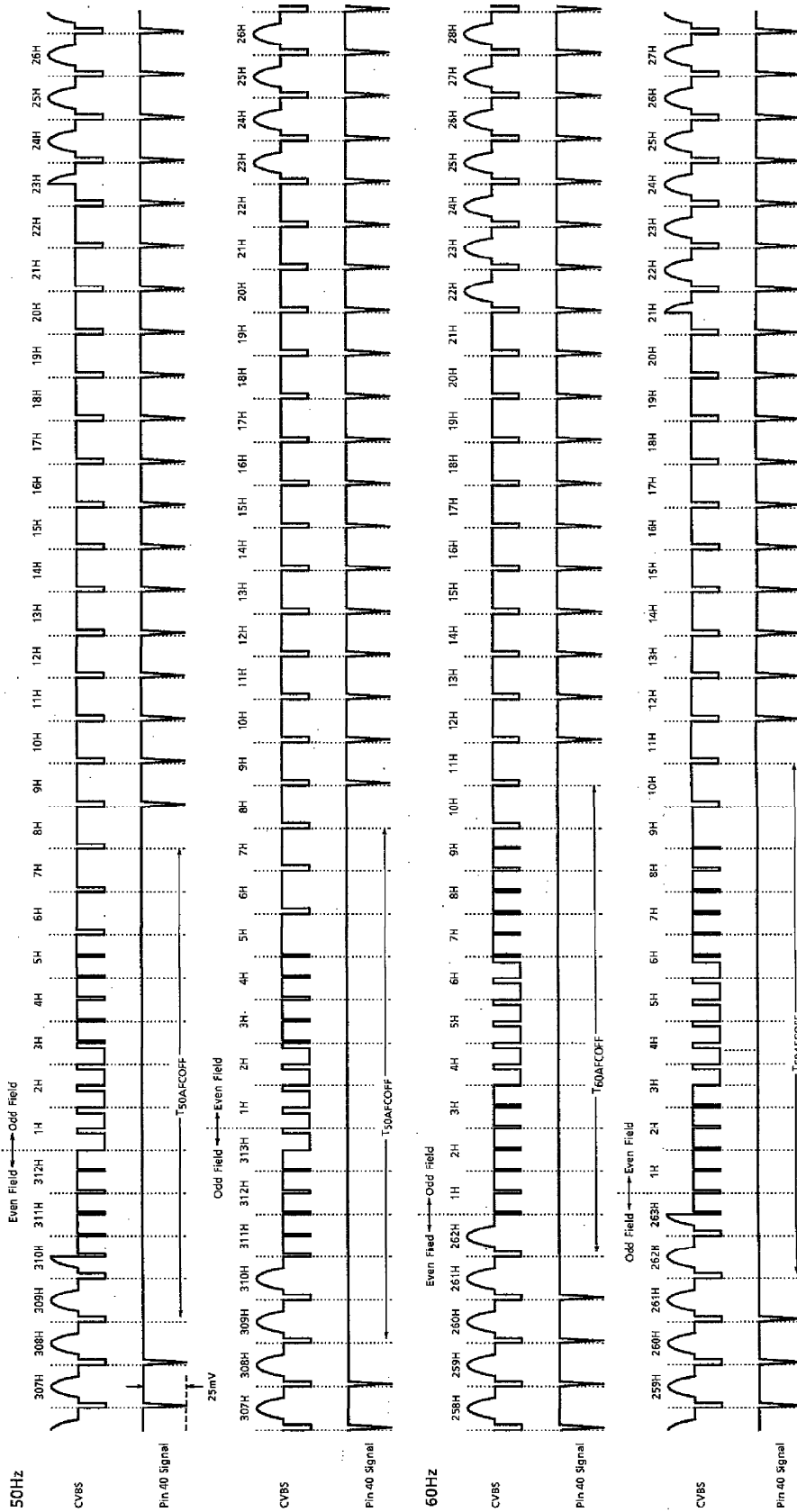
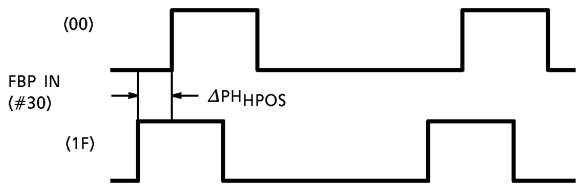
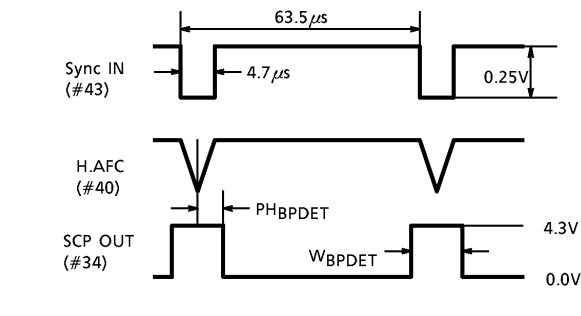
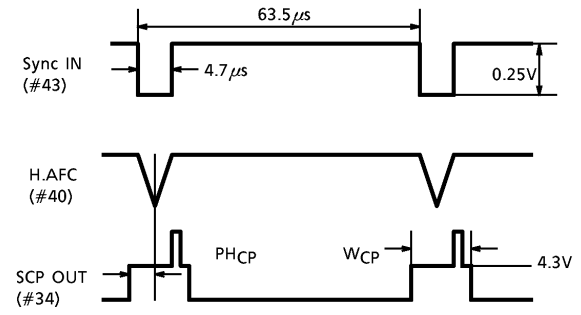
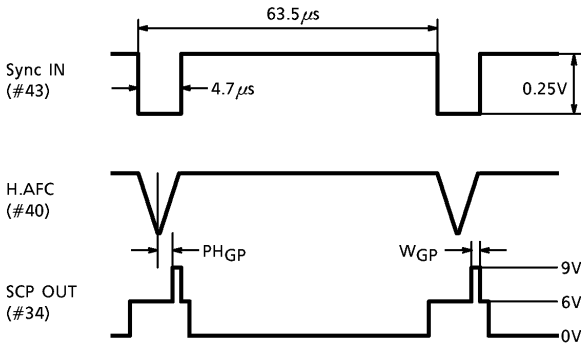
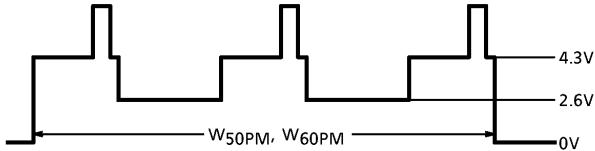

Fig. D1

TB1231AN-65

NOTE	ITEM / SYMBOL	BUS CONDITION	MEASUREMENT METHOD
D12	Horizontal Position Variable Range / ΔPH_{HPOS}	H Position : 0 / 31 Others : Preset	<p>(1) Input a composite sync signal into Pin 43. (2) Changing Horizontal Position from 0 to 31, measure "ΔPH_{HPOS}" according to the following figure.</p> 
D13	AFC-2 Pulse Threshold Level / V_{AFC2}	All : Preset	<p>(1) Input a composite sync signal into Pin 43. (2) Decreasing the FBP high level, measure the DC level at which H OUT phase changes against Sync Out phase, that is "V_{AFC2}".</p>
D14	H-BLK Pulse Threshold Level / V_{HBLK}	All : Preset	<p>(1) Input a composite sync signal into Pin 43. (2) Increasing the FBP high level, measure the DC level at which H blanking begins to work, that is "V_{HBLK}".</p>
D15	Black Peak Det. Stop Period (H) / PH_{BPDET} / WB_{BPDET}	TEST : 00001000 Others : Preset	<p>(1) Input a composite sync signal into Pin 43. (2) According to the following figure, measure "PH_{BPDET}" & "WB_{BPDET}".</p> 
D16	Clamp Pulse Start Phase / PH_{CP} Clamp Pulse Width / W_{CP}	TEST : 00001000 V Position : 001 Others : Preset	<p>(1) Input a composite sync signal into Pin 43. (2) According to the following figure, measure "PH_{CP}" & "W_{CP}".</p> 

NOTE	ITEM / SYMBOL	BUS CONDITION	MEASUREMENT METHOD
D17	Gate Pulse Start Phase / PH _{GP}	All : Preset	<p>(1) Input a composite sync signal into Pin 43. (2) According to the following figure, measure "PH_{GP}" & "W_{GP}".</p> 
	Gate Pulse Width / W _{GP}		
D18	Sync. Output Low Level / V _{SYNCL}	All : Preset	<p>(1) Input a composite sync signal into Pin 43. (2) Measure the DC voltage of Sync Out low level, that is "V_{SYNCL}".</p>
D19	Vertical Oscillation Start Voltage / V _{VON}	All : Preset	<p>(1) Let Pin 3 / 17 / 52 / 36 / 46 be open. (2) Increasing Pin 28 voltage, measure the voltage at which V Ramp signal appears at Pin 22, that is "V_{VON}".</p>
D20	Vertical Free-Run Frequency / F _{VAUFR} / F _{V60FR}	V-Freq : 00 / 01 Others : Preset	<p>For V-Freq 00 / 01, measure the frequency of V Ramp at Pin 22, that is "F_{VAUFR}" / "F_{V60FR}".</p>
D21	Gate Pulse V-Masking Period / T _{50GPM} / T _{60GPM}	All : Preset	<p>(1) Input a 50Hz / 60Hz composite sync signal into Pin 43. (2) Measure "T_{50GPM}" / "T_{60GPM}" at Pin 34. (cf. Fig.D21)</p>
D22	V.Ramp DC on Service Mode / V _{NOVRAMP}	MUTE : 11 Others : Preset	<p>Measure the DC level of Pin 22, that is "V_{NOVRAMP}".</p>

NOTE	ITEM / SYMBOL	BUS CONDITION	MEASUREMENT METHOD
D23	Vertical Pull-in Range (Auto) /FVPAUL /FVPAUH <hr/> Vertical Pull-In Range (60Hz) /FVP60L /FVP60H	V-Freq : 00 / 01 Others : Preset	(1) Input a composite sync signal into Pin 43. (2) For V-Freq 00 / 01, increasing the input vertical period from 220H by 0.5H step, measure the period at which V OUT signal synchronized with Sync out, that is "FVPAUL" / "FVP60L". (3) For V-Freq 00 / 01, decreasing the input vertical period from 360H by 0.5H step, measure the period at which V OUT signal synchronized with Sync out, that is "FVPAUL" / "FVP60L".
D24	Vertical Period on Fixed Mode /TV313 /TV263	V-Freq : 10 / 11 Others : Preset	For V-Freq 10 / 11, measure the vertical period at Pin 34, that is "TV263" / "TV313".
D25	V-BLK Start Phase /PH50VBLK /PH60VBLK <hr/> V-BLK Width /W50VBLK /W60VBLK	All : Preset	(1) Input a 50Hz / 60Hz composite sync signal into Pin 43. (2) Measure "T50AFCOFF" / "T60AFCOFF" at Pin 40. (cf. Fig.D25)
D26	Picture Mute Period /W50PM /W60PM	TEST : 00001000 Others : Preset	(1) Input a 50Hz / 60Hz composite sync signal into Pin 43. (2) According to a following figure, measure "W50PM" / "W60PM". 

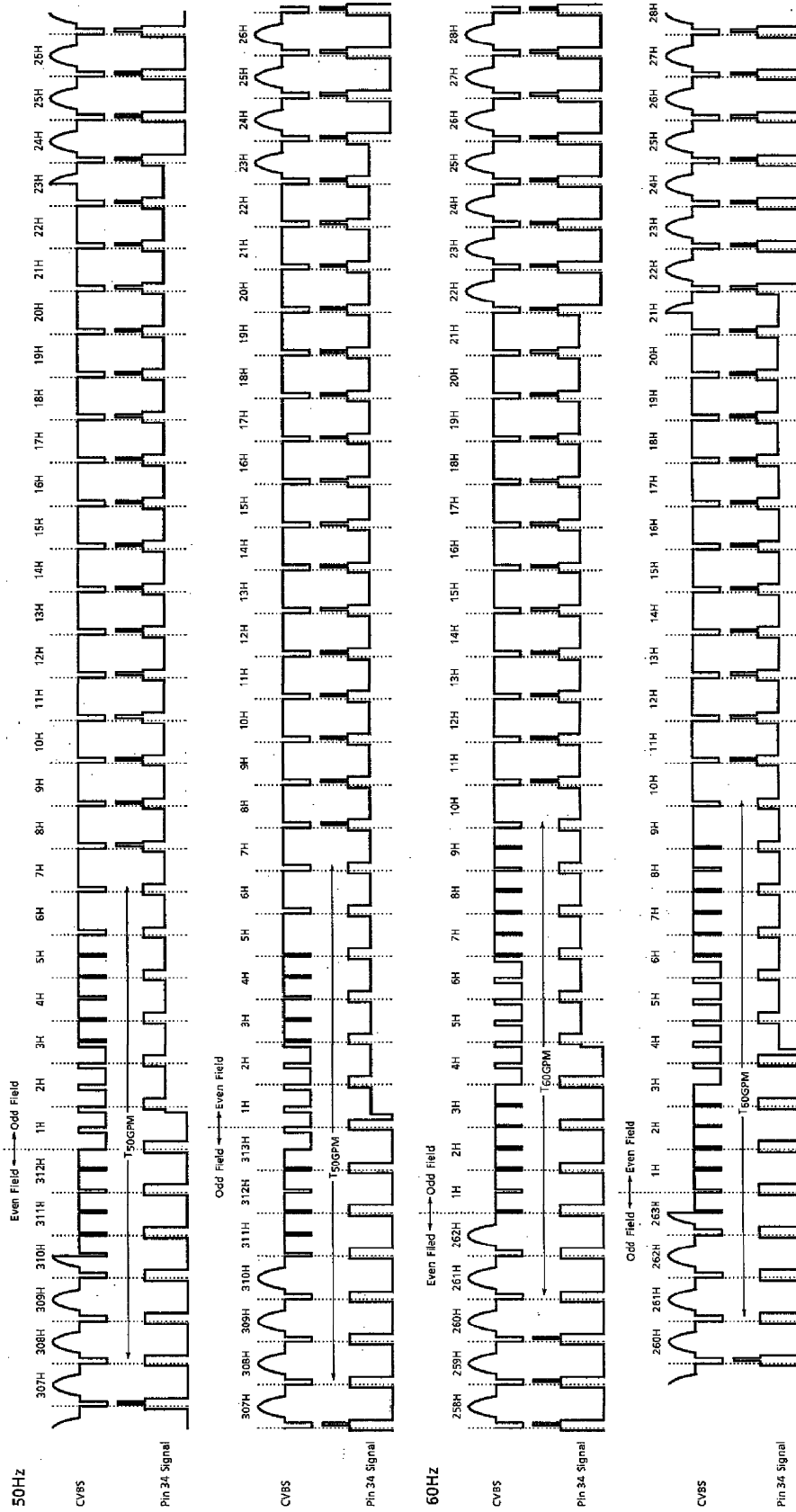

Fig. D21

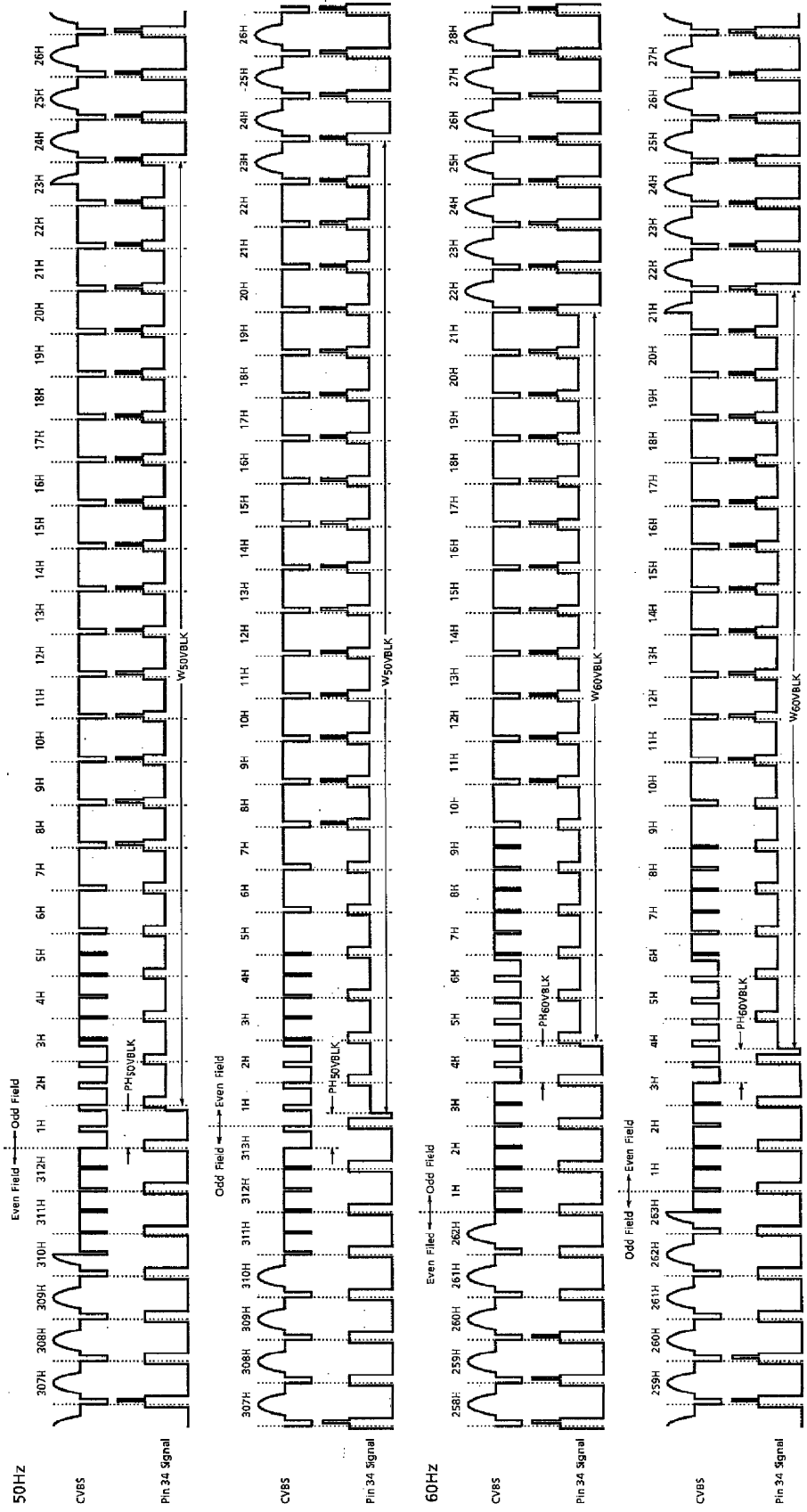
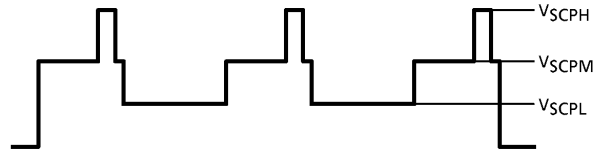
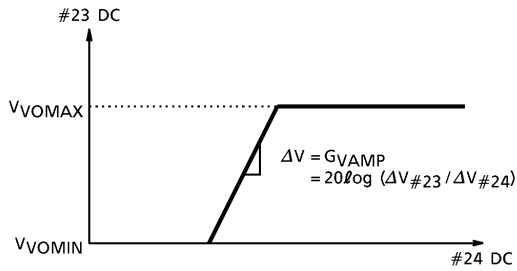
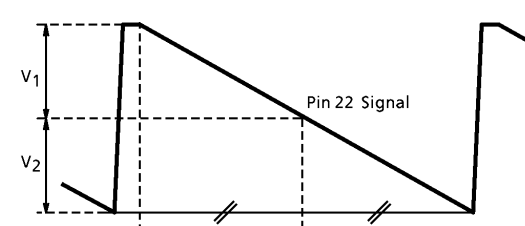
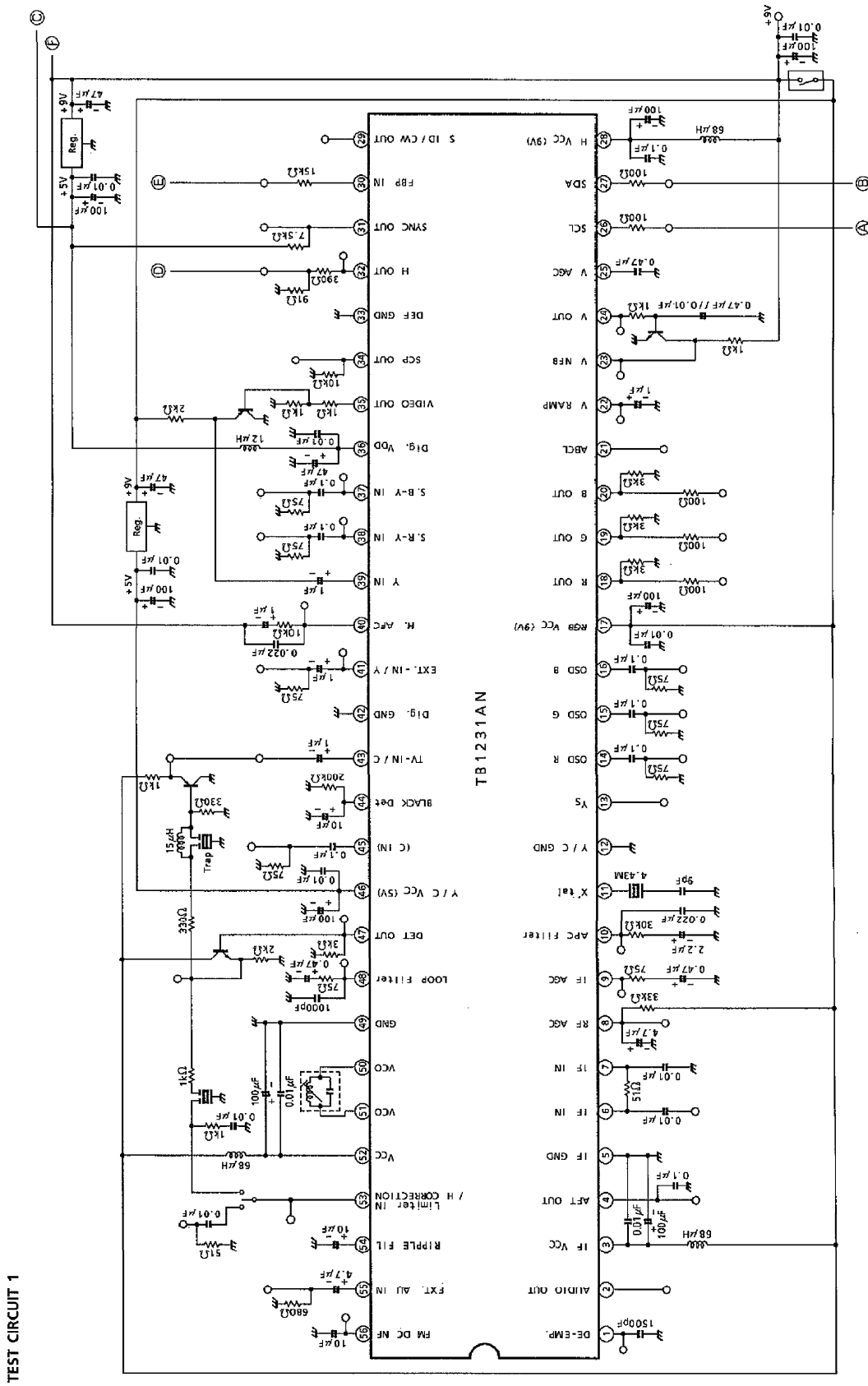

Fig. D25

TB1231AN 70

NOTE	ITEM / SYMBOL	BUS CONDITION	MEASUREMENT METHOD
D27	Sand Castle Pulse Level /V _{SCPH} /V _{SCPM} /V _{SCPL}	All : Preset	Measure "V _{SCPH} " / "V _{SCPM} " / "V _{SCPL} " at Pin 34. 
D28	Vertical Ramp Amplitude /V _{VRAMP}	All : Preset	Measure the V Ramp amplitude at Pin 22, that is "V _{VRAMP} ".
D29	Vertical AMP Gain /G _{VAMP}	All : Preset	(1) Let Pin 24 be open. (2) Changing the Pin 23 DC voltage, measure "V _{VOMAX} " / "V _{VOMIN} " / "G _{VAMP} " according to a following figure. 
	Vertical AMP Max. Output Level /V _{VOMAX}		
	Vertical AMP Min. Output Level /V _{VOMIN}		
D30	Vertical AMP Max. Output Current /I _{VOMAX}	All : Preset	(1) Supply 7V to Pin 23. (2) Measure the Current from Pin 24 to GND, that is "I _{VOMAX} ".
D31	Vertical NFB Amplitude /V _{NFB}	V Size : 0 / 32 / 63 Others : Preset	(1) Measure the amplitude of NFB V Ramp at Pin 23, that is "V _{NFB} ". (2) Measure the amplitude of NFB V Ramp at Pin 23 for V-Size 0 / 63, that is V _{NFBMIN} / V _{NFBMAX} . (3) Calculate ; "ΔV _{VRAMPH} " = (V _{NFBMAX} - V _{NFB}) / V _{NFB} * 100 "ΔV _{VRAMPL} " = (V _{NFBMIN} - V _{NFB}) / V _{NFB} * 100
	Vertical Amplitude Variable Range /ΔV _{VRAMPH} /ΔV _{VRAMPL}		

NOTE	ITEM / SYMBOL	BUS CONDITION	MEASUREMENT METHOD
D32	Vertical Linearity Variable Range / ΔV_{LIN1+} / ΔV_{LIN1-} / ΔV_{LIN2+} / ΔV_{LIN2-}	V Linearity : 0 / 8 / 15 Others : Preset	(1) For V linearity 8, Measure V_1 (From center to max.) and V_2 (From center to min.) at Pin 22 according to a following figure.  (2) For V linearity 15 / 0, measure V_{LIN1+} / V_{LIN1-} and V_{LIN2+} / V_{LIN2-} . (3) Calculate ; $"\Delta V_{LIN1+}" = (V_{LIN1+} - V_1) / V_1 * 100$ $"\Delta V_{LIN1-}" = (V_{LIN1-} - V_1) / V_1 * 100$ $"\Delta V_{LIN2+}" = (V_{LIN2+} - V_2) / V_2 * 100$ $"\Delta V_{LIN2-}" = (V_{LIN2-} - V_2) / V_2 * 100$
D33	Vertical S Correction Variable Range / ΔV_{S1+} / ΔV_{S1-} / ΔV_{S2+} / ΔV_{S2-}	V S Corr. : 0 / 8 / 15 Others : Preset	(1) For V S Correction : 8, measure V_1 and V_2 at Pin 22 according to a figure of NOTE : D32. (2) For V S Correction : 15 / 0, measure V_{S1+} / V_{S1-} and V_{S2+} / V_{S2-} . (3) Calculate ; $"\Delta V_{S1+}" = (V_{S1+} - V_1) / V_1 * 100$ $"\Delta V_{S1-}" = (V_{S1-} - V_1) / V_1 * 100$ $"\Delta V_{S2+}" = (V_{S2+} - V_2) / V_2 * 100$ $"\Delta V_{S2-}" = (V_{S2-} - V_2) / V_2 * 100$
D34	V-AGC Current / I_{VAGCH} / I_{VAGCL}	V-AGC : 0 / 1 Others : Preset	(1) Connect Pin 25 to GND via a 200 resistor. (2) For V-AGC : 0 / 1, measure V_{VAGCL} / V_{VAGCH} at Pin 25 according to a following figure. (3) Calculate ; $"I_{VAGCL}" = V_{VAGCL} / 200$ $"I_{VAGCH}" = V_{VAGCH} / 200$
D35	Vertical Guard Voltage / V_{VG}	All : Preset	Decreasing the Pin 23 voltage from 5V, measure the voltage at which Pin 20 output drops to blanking level, that is " V_{VG} ".



TB1231AN - 73

TEST CIRCUIT 2

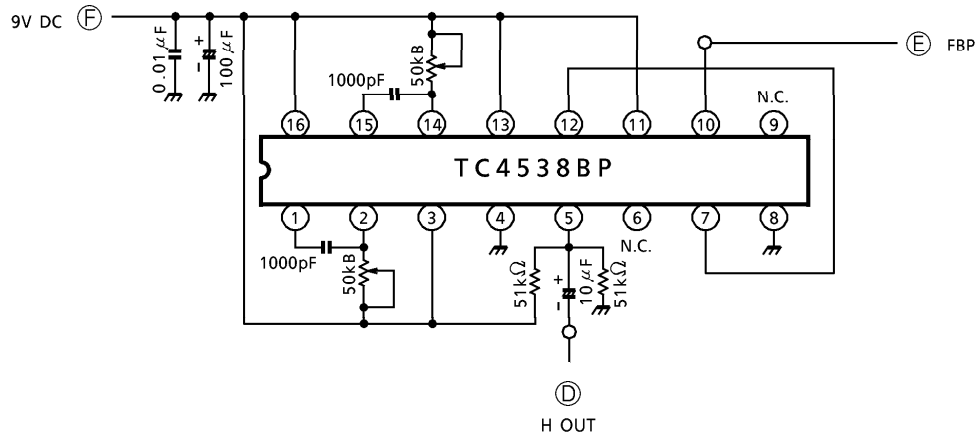

Mono Multi Vibrator

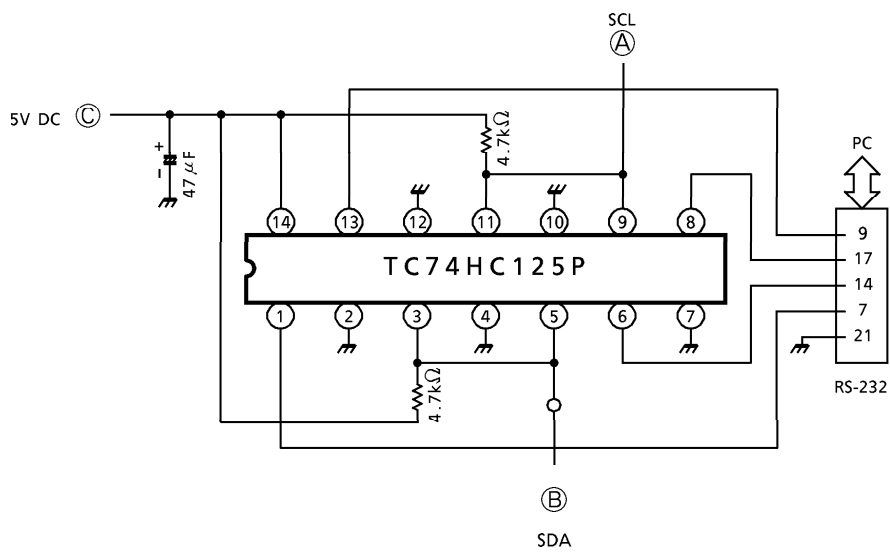

I²C BUS Interface

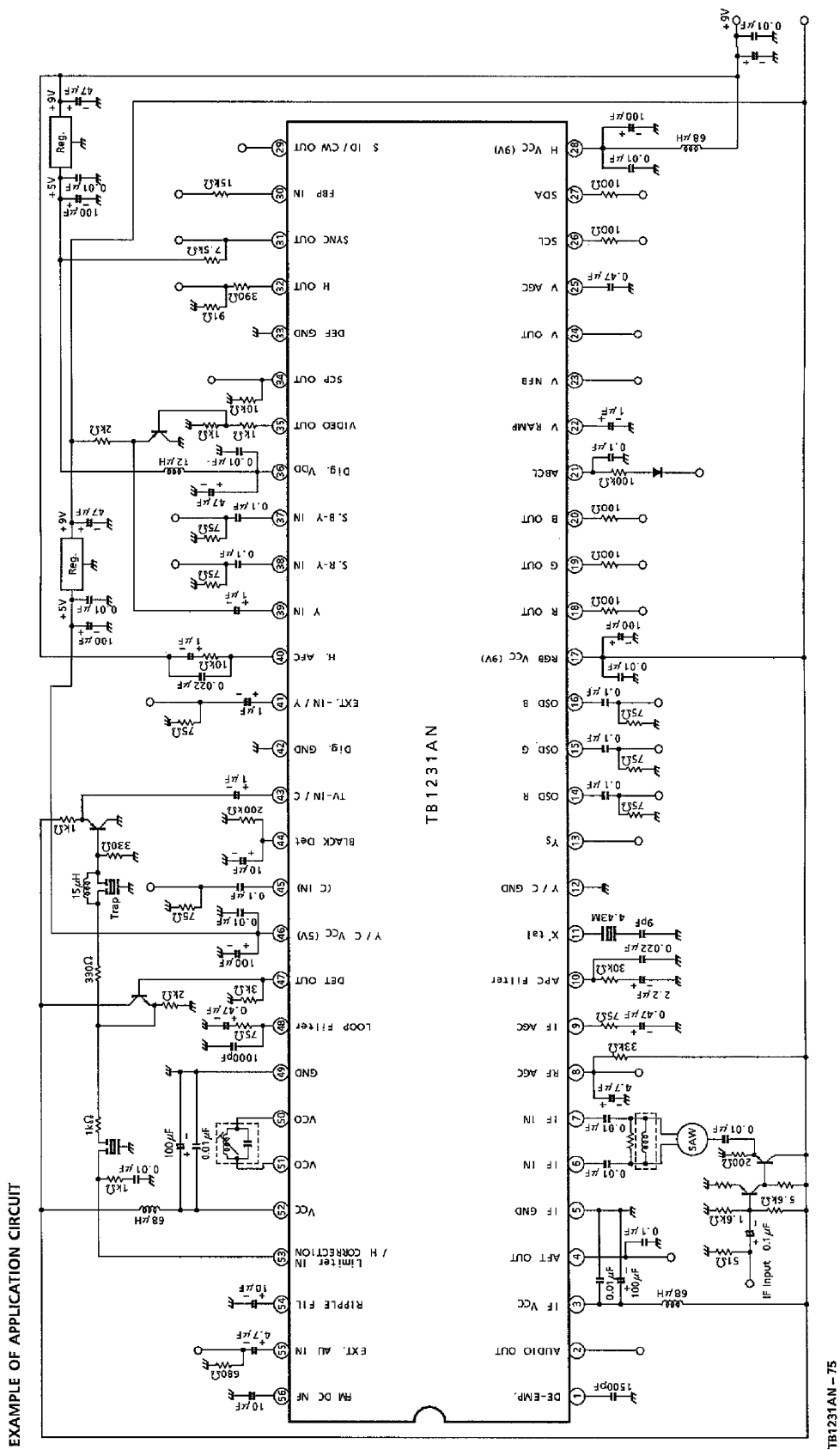

OUTLINE DRAWING
SDIP56-P-600-1.78

Unit : mm

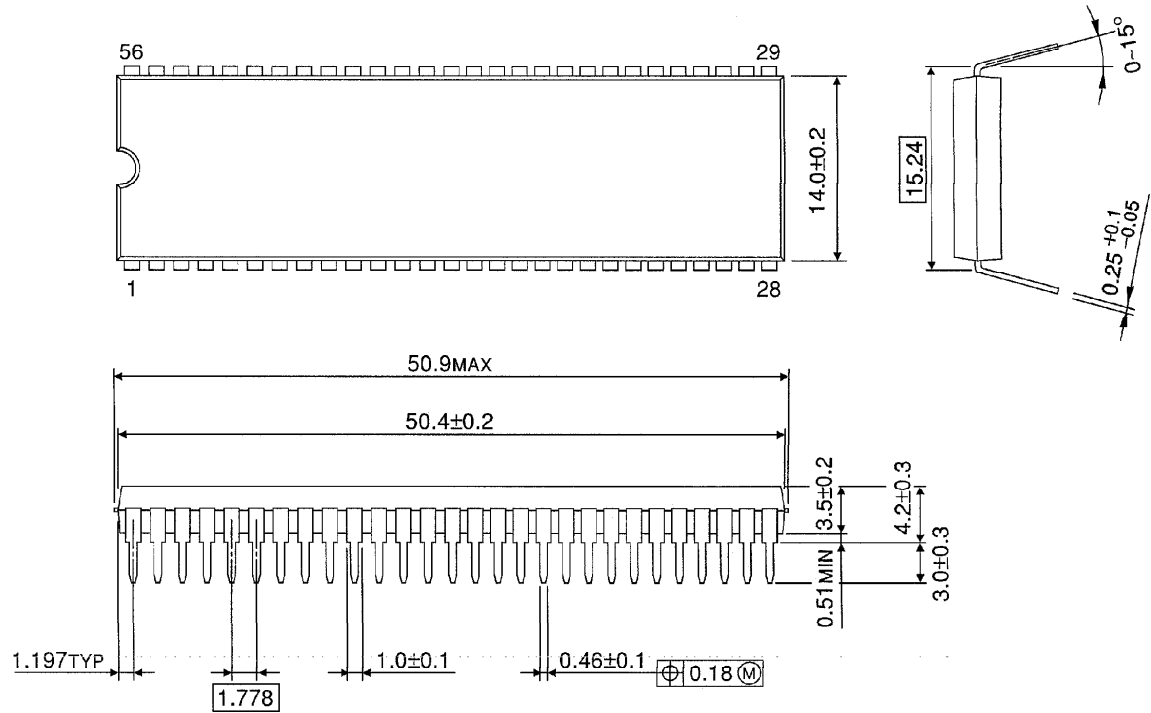

Weight : 5.55g (Typ.)