

INTERLEAVED DUAL PWM CONTROLLER WITH PROGRAMMABLE MAX DUTY CYCLE

FEATURES

- 2-MHz High Frequency Oscillator With 1-MHz Operation Per Channel
- Matched Internal Slope Compensation
- Programmable Maximum Duty Cycle Clamp 60% to 90% per channel
- Peak Current Mode Control With Cycle-by-Cycle Current Limit
- Current Sense Discharge Transistor for Improved Noise Immunity
- Accurate Line Under and Over voltage Sense With Programmable Hysteresis
- Opto-Coupler Interface
- 110-V Internal Start-Up JFET On UCC28221
- Operates Off 12-V Supply for UCC28220
- Programmable Soft-Start

APPLICATIONS

- High Output Current (50 A to 100 A) Converters
- Maximum Density Designs
- High Efficiency 48-V Input With Low Output Ripple Converters
- High Power Offline, Telecom and Datacom Power Supplies

DESCRIPTION

The UCC28220 and UCC28221 are a family of BiCMOS interleaved dual channel PWM controllers. Peak current mode control is used to ensure current sharing between the two channels. A precise maximum duty cycle clamp can be set to any value between 60% and 90% duty cycle per channel.

UCC28220 has UVLO turn-on threshold of 10 V for use in 12-V supplies while UCC28221 has turn-on threshold of 13-V for systems needing wider UVLO hysteresis. Both have 8-V turn-off thresholds.

TYPICAL APPLICATION

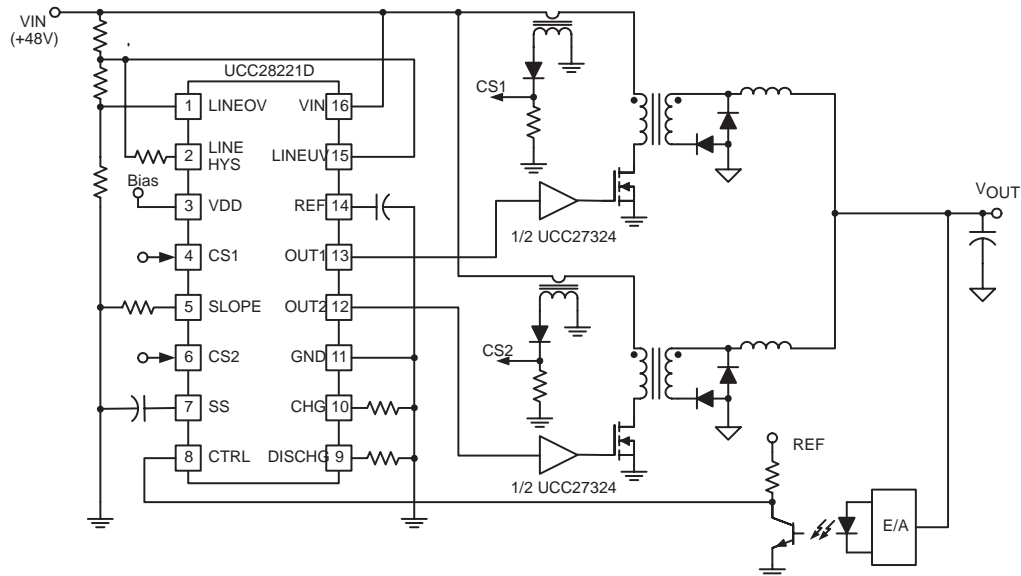

NOTE: Pin 16 is a no connect (N/C) on UCC28220 which does not include the JFET option.



Please be aware that an important notice concerning availability, standard warranty, and use in critical applications of Texas Instruments semiconductor products and disclaimers thereto appears at the end of this data sheet.

PRODUCTION DATA information is current as of publication date. Products conform to specifications per the terms of Texas Instruments standard warranty. Production processing does not necessarily include testing of all parameters.

DESCRIPTION (CONTINUED)

Additional features include a programmable internal slope compensation with a special circuit which is used to ensure exactly the same slope is added to each channel and a high voltage 110-V internal JFET for easier startup for the wider hysteresis UCC28221 version.

The UCC28220 is available in both 16-pin SOIC and low-profile TSSOP packages. The UCC28221 also comes in 16-pin SOIC package and a slightly larger 20-pin TSSOP package to allow for high voltage pin spacing to meet UL1950 creepage clearance safety requirements.

ORDERING INFORMATION

TEMPERATURE RANGE T _A = T _J	UVLO THRESHOLDS	110-V HV JFET STARTUP CIR- CUIT	PACKAGED DEVICES		
			SOIC-16 (D)	TSSOP-16 (PW)	TSSOP-20 (PW)
-40°C to +105°C	10 V on / 8 V off	NO	UCC28220D	UCC28220PW	–
	13 V on / 8 V off	YES	UCC28221D	–	UCC28221PW

NOTE: D (SOIC) and PW (TSSOP) packages are available taped and reeled. Add R suffix to device type, e.g. UCC28220DR or UCC28221PWR. The reel quantities are 2,500 devices per reel for D package and 2,000 devices per reel for the PW package.

CONNECTION DIAGRAM

UCC28220D, UCC28220PW
and UCC28221D PACKAGE
(TOP VIEW)

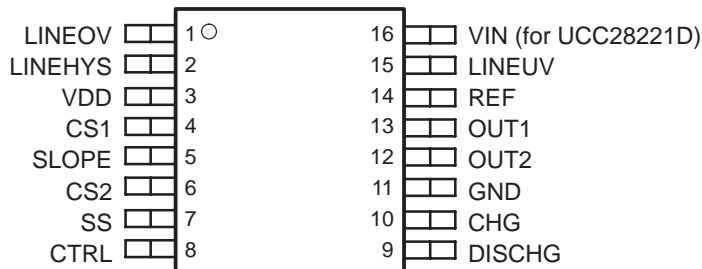

UCC28221PW PACKAGE
(TOP VIEW)

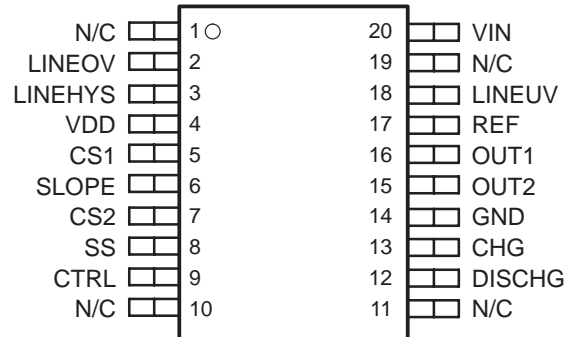

RECOMMENDED OPERATION CONDITIONS

Parameter	Symbol	Condition
High voltage start-up input	V _{IN}	36 V to 76 V
Supply voltage	V _{DD}	8 V to 14.5 V

ABSOLUTE MAXIMUM RATINGSover operating free-air temperature (unless otherwise noted)^{†‡}

Parameter	UCC2822X	UNIT
High voltage start-up input, V_{IN}	110	V
Supply voltage, V_{DD}	15	V
Output current (OUT1, OUT2) dc, $I_{OUT(dc)}$	±10	mA
OUT1/ OUT2 capacitive load	200	pF
REF output current, I_{REF}	10	mA
Current sense inputs, CS1, CS2	-1.0 to 2.0	V
Analog inputs (CHG, DISCHG, SLOPE, REF, CNTRL)	-0.3 to 3.6	V
Analog inputs (SS, LINEOV, LINEUV, LINEHYS)	-0.3 to 7.0	V
Power dissipation at $T_A = 25^\circ\text{C}$ (PW package)	400	mW
Power dissipation at $T_A = 25^\circ\text{C}$ (D package)	650	mW
Junction operating temperature, T_J	-55 to 150	$^\circ\text{C}$
Storage temperature, T_{stg}	-65 to 150	$^\circ\text{C}$
Lead temperature (soldering, 10 sec.), T_{sol}	300	$^\circ\text{C}$

[†] Stresses beyond those listed under “absolute maximum ratings” may cause permanent damage to the device. These are stress ratings only, and functional operation of the device at these or any other conditions beyond those indicated under “recommended operating conditions” is not implied. Exposure to absolute-maximum-rated conditions for extended periods may affect device reliability.

[‡] All voltages are with respect to GND. Currents are positive into, negative out of the specified terminal. Consult Packaging Section of the Databook for thermal limitations and considerations of packages.

ELECTRICAL CHARACTERISTICS:

$V_{DD} = 12\text{ V}$, 0.1- μF capacitor from VDD to GND, 0.1- μF capacitor from REF to GND, $F_{OSC} = 1\text{ MHz}$, $T_A = -40^\circ\text{C}$ to 105°C , $T_A = T_J$, (unless otherwise noted).

PARAMETER	TEST CONDITION	MIN	TYP	MAX	UNITS
Overall Section					
Operating VDD range		8		14	V
Quiescent current	SS = 0 V, no switching, $F_{osc} = 1\text{ MHz}$	1.5	3	4	mA
Operating current	Outputs switching, $F_{osc} = 1\text{ MHz}$	1.6	3.5	6	
Startup Section					
Startup current	UCC28220 $V_{DD} < (UVLO - 0.8)$			200	μA
Startup current	UCC28221 $V_{DD} < (UVLO - 0.8)$			500	
UVLO start threshold	UCC28220	9.5	10	10.5	V
UVLO start threshold	UCC28221	12.3	13	13.7	
UVLO stop threshold		7.6	8	8.4	
UVLO hysteresis	UCC28220	1.8	2	2.2	V
UVLO hysteresis	UCC28221	4.8	5	5.2	V
JFET ON threshold	SS = 0, outputs not switching, VDD decreasing	9.5	10	10.5	
JFET ON threshold	SS = 2 V, Cntrl = 2 V, output switching, VDD decreasing; same threshold as UVLO stop	7.6	8	8.4	
High voltage JFET current	$V_{IN} = 36\text{ V to }76\text{ V}$, $V_{DD} = 0\text{ V}$	16	48	100	mA
High voltage JFET current	$V_{IN} = 36\text{ V to }76\text{ V}$, $V_{DD} = 10\text{ V}$	4	16	40	
High voltage JFET current	$V_{IN} = 36\text{ V to }76\text{ V}$, $V_{DD} < UVLO$	4	12	40	
JFET leakage	$V_{IN} = 36\text{ V to }76\text{ V}$, $V_{DD} = 14\text{ V}$			100	μA

ELECTRICAL CHARACTERISTICS:

$V_{DD} = 12\text{ V}$, $0.1\text{-}\mu\text{F}$ capacitor from V_{DD} to GND , $0.1\text{-}\mu\text{F}$ capacitor from REF to GND , $F_{OSC} = 1\text{ MHz}$, $T_A = -40^\circ\text{C}$ to 105°C , $T_A = T_J$, (unless otherwise noted).

PARAMETER	TEST CONDITION	MIN	TYP	MAX	UNITS
Reference					
Output voltage	$8\text{ V} < V_{DD} < 14\text{ V}$, $I_{LOAD}=0\text{ mA}$ to -10 mA	3.15	3.3	3.45	V
Output current	Outputs not switching; $CNTRL = 0\text{ V}$	10			mA
Output short circuit current	$V_{REF} = 0\text{ V}$	-40	-20	-10	mA
V_{REF} UVLO		2.55	3	3.25	V
Soft-Start					
SS charge current	$R_{CHG}=10.2\text{ k}\Omega$, $SS = 0\text{ V}$	-70	-100	-130	μA
SS discharge current	$R_{CHG}=10.2\text{ k}\Omega$, $SS = 2\text{ V}$	70	100	130	
SS initial voltage	$LINEOV=2\text{ V}$, $LINEUV = 0\text{ V}$	0.5	1	1.5	V
SS voltage at 0% dc	Point at which output starts switching	0.5	1.2	1.8	
SS voltage ratio		75%	90%	100%	
SS Max voltage	$LINEOV = 0\text{ V}$, $LINEUV = 2\text{ V}$	3	3.5	4	V
Oscillator and PWM					
Output frequency	$R_{CHG} = 10.2\text{ k}\Omega$, $R_{DISCHG} = 10.2\text{ k}\Omega$	450	500	550	kHz
Oscillator frequency	$R_{CHG} = 10.2\text{ k}\Omega$, $R_{DISCHG} = 10.2\text{ k}\Omega$	900	1000	1100	
Output maximum duty cycle	$R_{CHG} = 10.2\text{ k}\Omega$, $R_{DISCHG} = 10.2\text{ k}\Omega$, measured at $OUT1$ and $OUT2$	73%	75%	77%	%
CHG voltage		2	2.5	3	V
DISCHG voltage		2	2.5	3	
Slope Compensation					
Slope	$RSLOPE = 75\text{ k}\Omega$, $R_{CH} = 66\text{ k}\Omega$, $R_{DISCHG} = 44\text{ k}\Omega$, $C_{sx} = 0\text{ V}$ to 0.5 V	140	200	260	mV/us
Channel matching	$RSLOPE = 75\text{ k}\Omega$, $C_{sx} = 0\text{ V}$		0%	10%	
Current Sense					
CS1, CS2 bias current	$CS1 = 0$, $CS2 = 0$	-500	0	500	nA
Prop delay CSx to $OUTx$	CSx input 0 V to 1.5 V step		40	85	ns
CS1, CS2 sink current	$CSx = 2\text{ V}$	2.3	4.5	7	mA
CNTRL Section					
Resistor ratio ⁽¹⁾			0.6		
Ctrl input current	$CTRL = 0\text{ V}$ and 3.3 V	-100	0	100	nA
Ctrl voltage at 0% dc	$CSx = 0\text{ V}$, Point at which output starts switching (checks resistor ratio)	0.5	1.2	1.8	V

NOTES: (1). Ensured by design. Not 100% tested in production.

ELECTRICAL CHARACTERISTICS:

$V_{DD} = 12\text{ V}$, $0.1\text{-}\mu\text{F}$ capacitor from V_{DD} to GND , $0.1\text{-}\mu\text{F}$ capacitor from REF to GND , $F_{OSC} = 1\text{ MHz}$, $T_A = -40^\circ\text{C}$ to 105°C , $T_A = T_J$, (unless otherwise noted).

PARAMETER	TEST CONDITION	MIN	TYP	MAX	UNITS
Output Section (OUT1, OUT2)					
Low level	$I_{OUT} = 10\text{ mA}$		0.4	1	V
High level	$I_{OUT} = -10\text{ mA}$, $V_{REF} - V_{OUT}$		0.4	1	
Rise time	$C_{LOAD} = 50\text{ pF}$		10	20	ns
Fall time	$C_{LOAD} = 50\text{ pF}$		10	20	
LINE Sense section					
LINEOV threshold	$T_A = 25^\circ\text{C}$	1.240	1.260	1.280	V
LINEOV threshold	$T_A = -40^\circ\text{C}$ to 105°C	1.235	1.260	1.285	
LINEUV threshold	$T_A = 25^\circ\text{C}$	1.240	1.260	1.280	
LINEUV threshold	$T_A = -40^\circ\text{C}$ to 105°C	1.235	1.260	1.285	
LINEHYST pull up voltage	LINEOV = 2 V, LINEUV = 2 V	3.1	3.25	3.4	
LINEHYST off leakage	LINEOV = 0 V, LINEUV = 2 V	-500	0	500	nA
LINEHYS pull-up resistance	$I = -20\text{ }\mu\text{A}$		100	500	Ω
LINEHYS pull-down resistance	$I = 20\text{ }\mu\text{A}$		100	500	
LINEOV, LINEUV bias I	LINEOV = 1.25 V, LINEUV = 1.25 V	-500		500	nA

NOTES: (1). Ensured by design. Not 100% tested in production.

UCC28220, UCC28221

SLUS544 – SEPTEMBER 2003

FUNCTIONAL BLOCK DIAGRAM

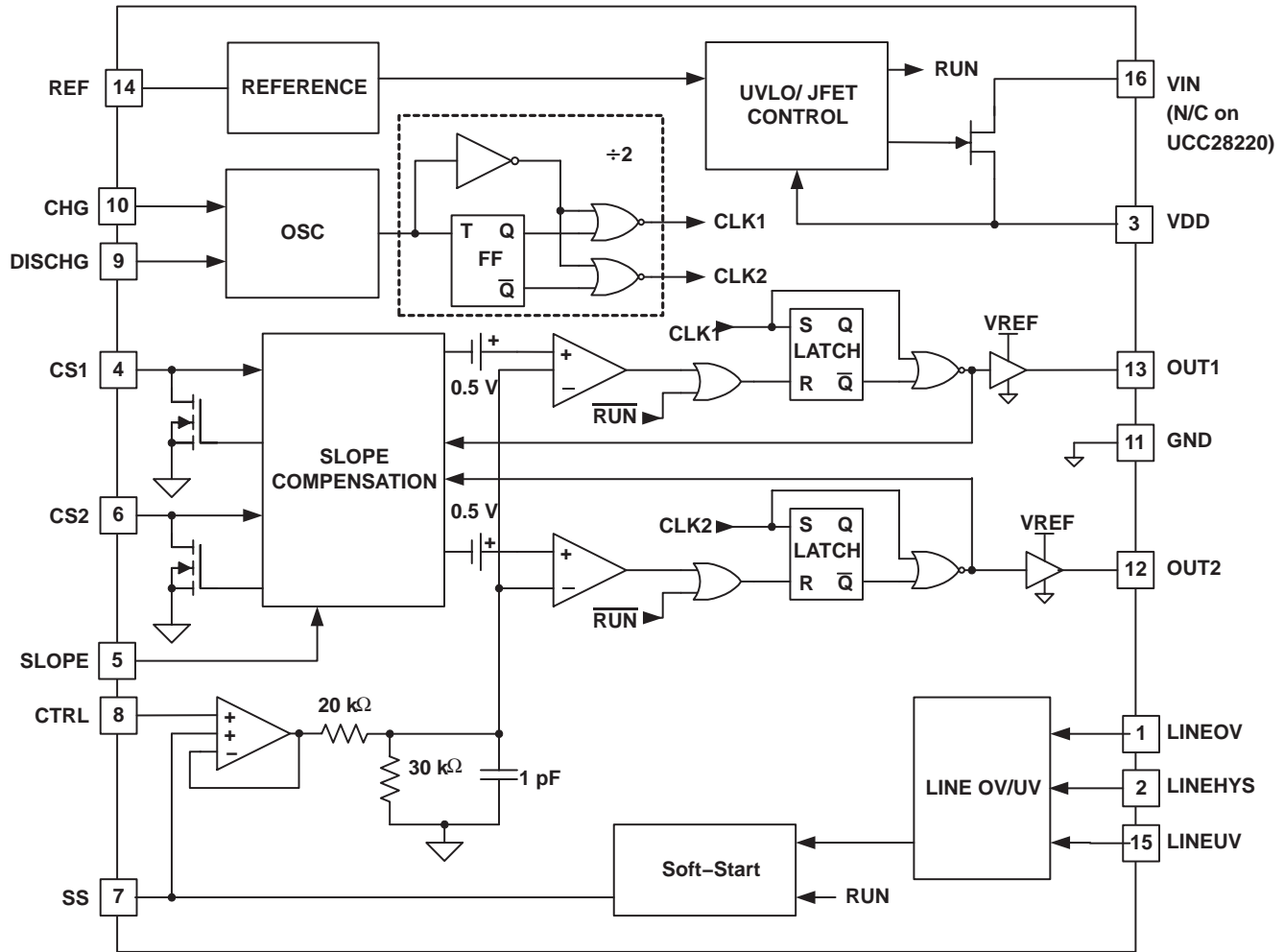

NOTE: Pinout for 16 pin option shown. See the 20-pin connection to UCC28221PW in the *Terminal Functions* table on the next page.

Terminal Functions

TERMINAL					FUNCTION
PIN NUMBER			NAME	I/O	
UCC28220D UCC28220PW	UCC28221D	UCC28221PW			
1	1	2	LINEOV	I	Input for line over voltage comparator
2	2	3	LINEHYS	I	Sets line comparator hysteresis
3	3	4	VDD	I	Device supply input
4	4	5	CS1	I	Channel 1 current sense input
5	5	6	SLOPE	I	Sets slope compensation
6	6	7	CS2	I	Channel 2 current sense input
7	7	8	SS	I	Soft-start input
8	8	9	CTRL	I	Feedback control input
9	9	12	DISCHG	I	Sets oscillator discharge current
10	10	13	CHG	I	Sets oscillator charge current
11	11	14	GND	–	Device ground
12	12	15	OUT2	O	PWM output from channel 2
13	13	16	OUT1	O	PWM output from channel 1
14	14	17	REF	O	Reference voltage output
15	15	18	LINEUV	I	Input for line under voltage comparator
–	16	20	VIN	I	High voltage start-up input
16	–	1, 10, 11, 19	N/C	–	No connection

PIN DESCRIPTIONS

VDD: This is used to supply power to the device, monitoring this pin is a the UVLO circuit. This is used to insure glitch-free startup operation. Until VDD reaches its UVLO threshold, it remains in a low power mode, drawing approximately 150 μ A of current and forcing pins, SS, CS1, CS2, OUT1, and OUT2 to logic 0 states. If the VDD falls below 8 V after reaching turn-on, it will go back into this low power state. In the case of the UCC28221, the UVLO threshold is 13 V. It is 10 V for the UCC28220. Both versions have a turn-off threshold of 8 V.

VIN (UCC28221 only): This pin has an internal high voltage JFET used for startup. The drain is connected to VIN, while its' source is connected to VDD. During startup, this JFET delivers 12 mA typically with a minimum of 4 mA to VDD, which in turn, charges up the VDD bypass capacitor. When VDD gets to 13 V, the JFET is turned off.

CS1 and CS2: These 2 pins are the current sense inputs to the device. The signals are internally level shifted by 0.5 V before the signal gets to the PWM comparator. Internally the slope compensation ramp is added to this signal. The linear operating range on this input is 0 to 1.5 V. Also, this pin gets pulled to ground each time its respective output goes low. (ie: OUT1 and OUT2).

SLOPE: This pin sets up a current used for the slope compensation ramp. A resistor to ground sets up a current, which is internally divided by 25 and then applied to an internal 10-pF capacitor. Under normal operation th dc voltage on this pin is 2.5 V..

SS: A capacitor to ground sets up the soft-start time for the open loop soft-start function. The source and sink current from this pin is equal to 3/7th of the oscillator charge current set by the resistor on the CHG pin. The soft start capacitor is held low during UVLO and during a Line OV or UV condition. Once an OV or UV fault occurs, the soft-start capacitor is discharged by a current equal to its charging current. The capacitor does NOT quickly discharge during faults. In this way, the controller has the ability to recover quickly from very short line transients. This pin can also be used as an Enable/Disable function.

CHG: A resistor from this pin to GND sets up the charging current of the internal C_T capacitor used in the oscillator. This resistor, in conjunction with the resistor on the DISCHG pin is used to set up the operating frequency and maximum duty cycle. Under normal operation the dc voltage on this pin is 2.5 V.

DISCHG: A resistor from this pin to GND sets up the discharge current of the internal C_T capacitor used in the oscillator. This resistor, in conjunction with the resistor on the CHG pin is used to set up the operating frequency and maximum duty cycle. Under normal operation the dc voltage on this pin is 2.5 V.

OUT1 and OUT2: These output buffers are intended to interface with high current MOSFET drivers. The output drive capability is approximately 33 mA and has an output impedance of 100 Ω . The outputs swing between GND and REF.

LINEOV: This pin is connected to a comparator and used to monitor the line voltage for an over voltage condition. The typical threshold is 1.26 V.

LINEUV: This pin is connected to a comparator and used to monitor the line voltage for an under voltage condition. The typical threshold is 1.26 V.

LINEHYST: This pin is controlled by both the LINEOV and LINEUV pins. It is used to control the hysteresis values for both the over and under voltage line detectors.

REF: REF is a 3.3-V output used primarily as a source for the output buffers and other internal circuits. It is protected from accidental shorts to ground. For improved noise immunity it is recommended that the reference pin be bypassed with a minimum of 0.1 μ F of capacitance to GND.

APPLICATION INFORMATION

General

The device is comprised of several housekeeping blocks as well as two slope compensated PWM channels that are interleaved. The circuit is intended to run from an external VDD supply voltage between 8 V and 14 V, however, the UCC28221 has the addition of a high voltage startup JFET with control circuitry which can be used for system startup. Other functions contained in the device are supply UVLO, 3.3-V reference, accurate line OV and UV functions, a high speed programmable oscillator for both frequency and duty cycle, programmable slope compensation, and programmable soft start functions.

The UCC28220/1 is a primary side controller for a two channel interleaved power converter. The device is compatible with forward or flyback converters as long as a duty cycle clamp between 60 and 90 percent is required. The active clamp forward and flyback converters as well as the RCD and resonant reset forward converters are therefore compatible with this device. To ensure the two channels share the total converter output current, current mode control with internal slope compensation is used. Slope compensation is user programmable via a dedicated pin and can be set over a 50:1 range, ensuring good small-signal stability over a wide range of applications.

APPLICATION INFORMATION
LINE Over Voltage And Under Voltage

Three pins are provided to turn-off the output drivers and reset the soft-start capacitor when the converter input voltage is outside a prescribed range. The under-voltage set point and under-voltage hysteresis are accurately set via external resistors. The over-voltage set point is also accurately set via a resistor ratio, but the hysteresis is fixed by the same resistor that sets the under-voltage hysteresis.

Figure 1 and 2 show detailed functional diagram and operation of the under voltage lockout (UVLO) and over-voltage lockout (OVLO) features. The equations for setting the thresholds defined in Figure 2 are:

$$V1 = 1.26 \times \frac{R1}{(R2 + R3)} + 1.26 \quad (1)$$

$$V2 = 1.26 \times \frac{(R1 + Rx)}{Rx}, \text{ where } Rx = R4 \parallel (R2 + R3) \quad (2)$$

$$V4 = 1.26 \times \frac{(R1 + R2 + R3)}{R3} \quad (3)$$

$$V3 = V4 - 1.26 \times \left(\frac{R1}{R2} \right) \quad (4)$$

The UVLO hysteresis and the OVLO hysteresis can then be calculated as $V2 - V1$ and $V4 - V3$, respectively. By examining the design equations it becomes apparent that the value of $R4$ sets the amount of hysteresis at both thresholds. By realizing this fact, the designer can then set the value of $R4$ based on the most critical hysteresis specification either at high line or at low line. In most designs the value of $R4$ will be determined by the desired amount of hysteresis around the UVLO threshold. As an example consider a telecom power supply with the following input UVLO and OVLO design specifications:

- $V1 = 31.8 \text{ V}$
- $V2 = 34.0 \text{ V}$
- $V3 = 83.0 \text{ V}$
- $V4 = 84.7 \text{ V}$

Then,

- $R1 = 976 \text{ k}\Omega$
- $R2 = 24.9 \text{ k}\Omega$
- $R3 = 15.0 \text{ k}\Omega$

and

- $R4 = 604 \text{ k}\Omega$

APPLICATION INFORMATION

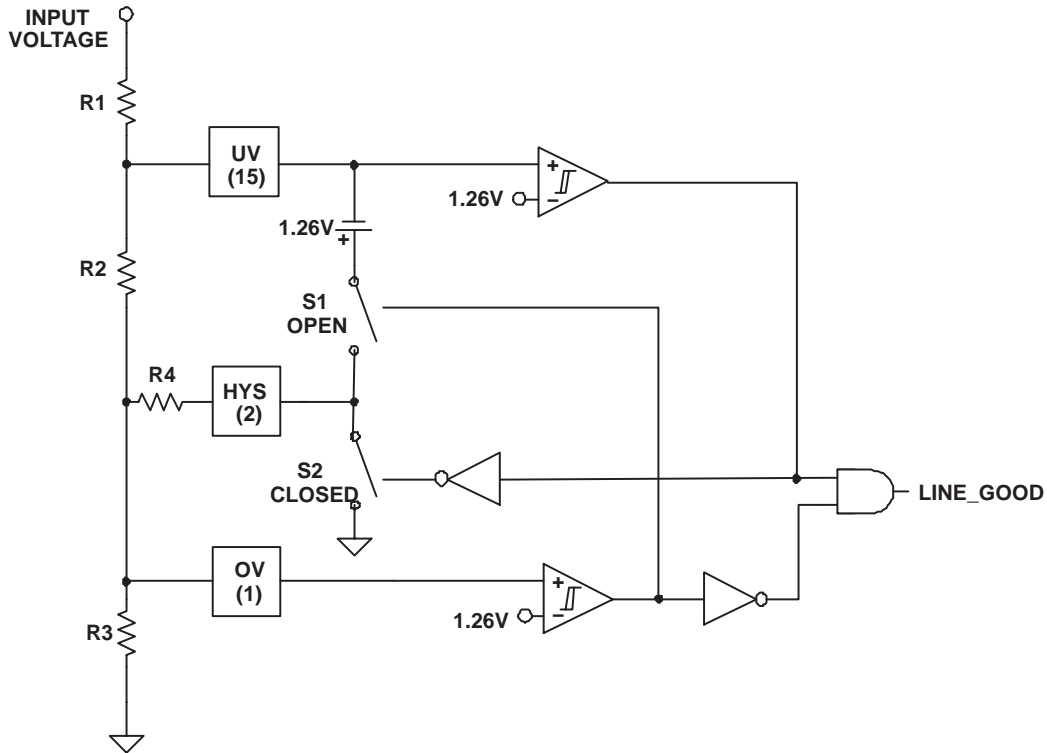

Figure 1. Line UVLO and OVLO Functional Diagram

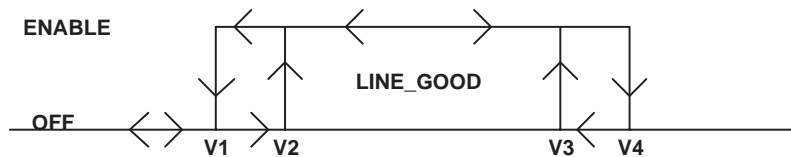

Figure 2. Line UVLO and OVLO Operation

VDD

Because the driver output impedance is high the energy storage requirements on the VDD capacitor is low. For improved noise immunity it is recommended that the VDD pin, be bypassed with a minimum of 0.1 μ F of capacitance to GND. In most typical applications the bias voltage for the MOSFET drivers will also be used as the VDD supply voltage for the chip. In the aforementioned applications it is beneficial to add a low valued resistor between the bulk storage capacitor of the driver and the VDD capacitor for the UCC28220/1. By adding a resistor in series with the bias supply any noise that is present on the bias supply will be filtered out before getting to the VDD pin of the controller.

APPLICATION INFORMATION

Reference

For improved noise immunity it is recommended that the reference pin, REF, be bypassed with a minimum of 0.1µF of capacitance to GND.

Oscillator Operation And Maximum Duty Cycle Setpoint

The oscillator uses an internal capacitor to generate the time base for both PWM channels. The oscillator is programmable over a 200 kHz to 2MHz frequency range with 20% to 80% maximum duty cycle range. Both the duty cycle and frequency of the oscillator are divided by 2 to generate the PWM clock and off-time information for each of the outputs. In this way, a 20% oscillator duty cycle corresponds to a 60% maximum duty cycle at each output, where an 80% oscillator duty cycle yields a 90% duty cycle clamp at each output.

The design equations for the Oscillator and Maximum Duty Cycle set point are given by:

$$F_{OSC} = 2 \times F_{OUT} \quad (5)$$

$$D_{MAX(osc)} = 1 - 2 \times (1 - D_{MAX(out)}) \quad (6)$$

$$R_{CHG} = K_{OSC} \times \frac{D_{MAX(osc)}}{F_{OSC}} \quad (7)$$

$$R_{DISCHG} = K_{OSC} \times \frac{(1 - D_{MAX(osc)})}{F_{OSC}} \quad (8)$$

Where:

- $K_{OSC} = 2.04 \times 10^{10}$ [Ω/s]
- F_{OUT} = Switching frequency at the outputs of the chip [Hz]
- $D_{MAX(out)}$ = Maximum Duty cycle limit at the outputs of the chip
- $D_{MAX(osc)}$ = Maximum duty cycle of the Oscillator for the desired maximum duty cycle at the outputs
- F_{OSC} = Oscillator frequency for desired output frequency [Hz]
- R_{CHG} = External Oscillator resistor which sets the charge current – [Ω]
- R_{DISCHG} = External Oscillator resistor which sets the discharge current – [Ω]

Start-Up JFET Section

A 110-V start-up JFET is included to start the device from a wide range (36 V–75 V) telecom input source. When VDD is lower than 13 V the JFET is on, behaving as a current source charging the bias capacitors on VDD and supplying current to the device. In this way, the VDD bypass capacitors are charged to 13 V where the outputs start switching and the JFET is turned off. To enable a constant bias supply to the device during a pulse skipping condition, the JFET is turned back on whenever VDD decreases below 10 V and the outputs are not switching. Thus, the current from the JFET can overcome the internal bias currents, as long as the device is not actively switching the output drivers. See Figure 2 below for a graphical representation of the JFET/VDD operation. The UCC28220 does not contain an internal JFET and has a startup threshold of 10 V which makes it capable of directly operating off a 12 V dc bus

APPLICATION INFORMATION

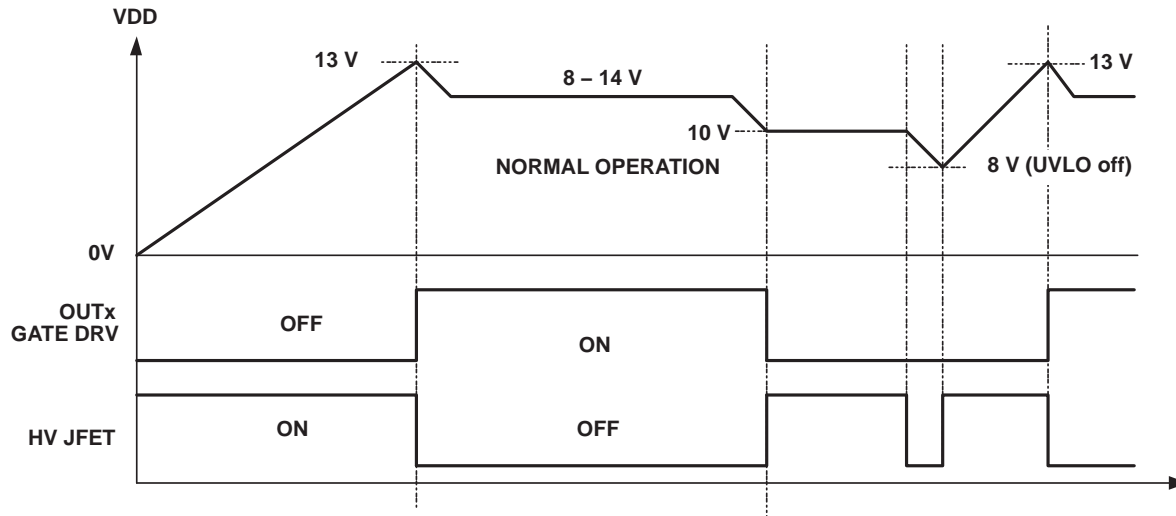

Figure 3. JFET Device Operation With VDD Voltage

Soft-Start

A current is forced out of the SS pin, equal to 3/7 of the current set by R_{CHG}, to provide a controlled ramp voltage. The current set by the R_{CHG} resistor is equal to 2.5 V divided by R_{CHG}. This ramp voltage overrides the commanded duty cycle on the CTRL pin, allowing a controlled start-up. Assuming the UCC28221 is biased on the primary side, the soft start should be quite quick to allow the secondary bias to be generated and the secondary side control can then take over. Once the soft-start time interval is complete, a closed loop soft-start on the secondary side can be executed.

$$ISS = \frac{3}{7} \times \frac{2.5}{R_{CHG}} \tag{9}$$

where,

ISS = current which is sourced out of the SS pin during the soft-start time – [Amps]

Current Sense

The current sense signals CS1 and CS2 are level shifted by 0.5 V and have the slope compensation ramps added to them before being compared to the control voltage at the input of the PWM comparators. The amplitude of the current sense signal at full load should be selected such that it is very close to the maximum control voltage in order to limit the peak output current during short circuit operation.

Output Drivers

The UCC28220/1 is intended to interface with the UCC27323/4/5 family of MOSFET drivers. As such, the output drive capability is low, effectively 100 Ω and the driver outputs swing between GND and REF.

APPLICATION INFORMATION

Slope Compensation

The slope compensation circuit in the UCC28220/1 operates on a cycle-by-cycle basis. The two channels have separate slope compensation circuits. These are fabricated in precisely the same way so as current sharing is unaffected by the slope compensation circuit. For each channel, an internal capacitor is reset whenever that channel's output is off. At the beginning of the PWM cycle, a current is mirrored off the SLOPE pin into the capacitor, developing an independent ramp. Since the two channel's ramps will start when the channel's output changes from a low to high state, the ramps are thus interleaved. These internal ramps are added to the voltages on the current sense pins, CS1 and CS2 and the result forms an input to the PWM comparators.

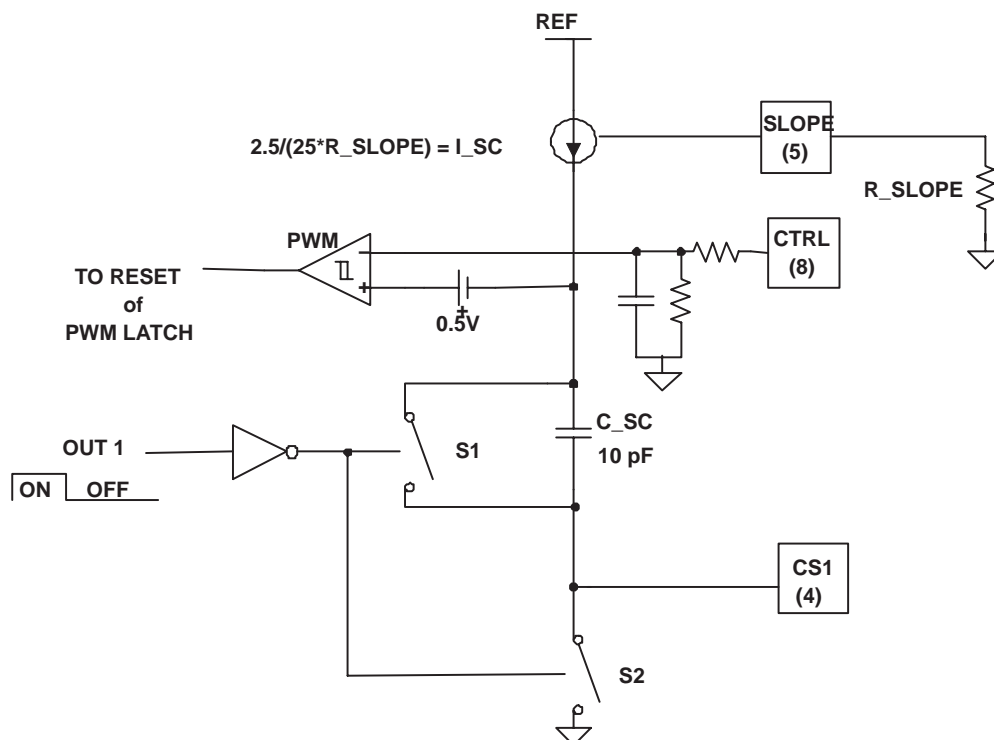

Figure 4. Slope Compensation Detail for Channel 1. Duplicate matched circuitry exists for channel 2.

To ensure stability, the slope compensation circuit must add between 1/5 and 1 times the inductor downslope to each of the current sense signals prior to being applied to the PWM comparator's input.

APPLICATION INFORMATION

Determining the value for the slope compensation resistor:

Design Example:

$N_{CT(p)} = 1$ $V_{OUT} = 12$ $N_p = 7$ $R_{SENSE} = 5.23$ $F_{S(out)} = 500000$
 $N_{CT(s)} = 50$ $L_{OUT} = 3.2 \times 10^{-6}$ $N_s = 5$ $V_{EA(cl)} = 1.98$

Where,

- $N_{CT(p)}$ = Number of primary turns on the Current Transformer – [Turns]
- $N_{CT(s)}$ = Number of Secondary turns on the current transformer – [Turns]
- V_{OUT} = Nominal output voltage of the converter – [V]
- L_{OUT} = Inductance value of each output inductor – [H]
- N_p = Number of primary turns on the main transformer – [Turns]
- N_s = Number of secondary turns on the main transformer – [Turns]
- R_{SENSE} = Value of current sense resistor on secondary of current sense transformer – [Ohms]
- $V_{EA(cl)}$ = Maximum Value of the E/A output voltage – [Volts]
- $F_{S(out)}$ = Switching frequency of each output – [Hz]

Determine the correct value for the slope resistor, R_{SLOPE} , to provide the desired amount of slope compensation.

$$N_{CT} = \frac{N_{CT(p)}}{N_{CT(s)}}, \text{ Current Transformer Turns Ratio}$$

1. Transform the Secondary Inductor Downslope to the Primary

$$S_{L(prime)} = \frac{V_{OUT}}{L_{OUT}} \times \frac{N_s}{N_p}, \quad S_{L(prime)} = 2.679 \text{ A}/\mu\text{s}$$

2. Calculate the Transformed Slope Voltage at Sense Resistor:

$$V_{S_{L(prime)}} = S_{L(prime)} \times N_{CT} \times R_{SENSE}, \quad V_{S_{L(prime)}} = 2.281 \text{ V}/\mu\text{s}$$

3. Calculate the R_{SLOPE} value to give a compensating ramp equal to the transformed slope voltage given above.:

$$M = 1.0$$

Desired ratio between the compensating ramp and the output inductor downslope ramp, transformed to the primary sense resistor

$$R_{SLOPE} = \frac{10^4}{(M \times V_{S_{L(prime)}} \times 10^{-6})}, \quad R_{SLOPE} = 35.556 \text{ k}\Omega$$

TYPICAL CHARACTERISTICS

UVLO THRESHOLDS
vs
TEMPERATURE

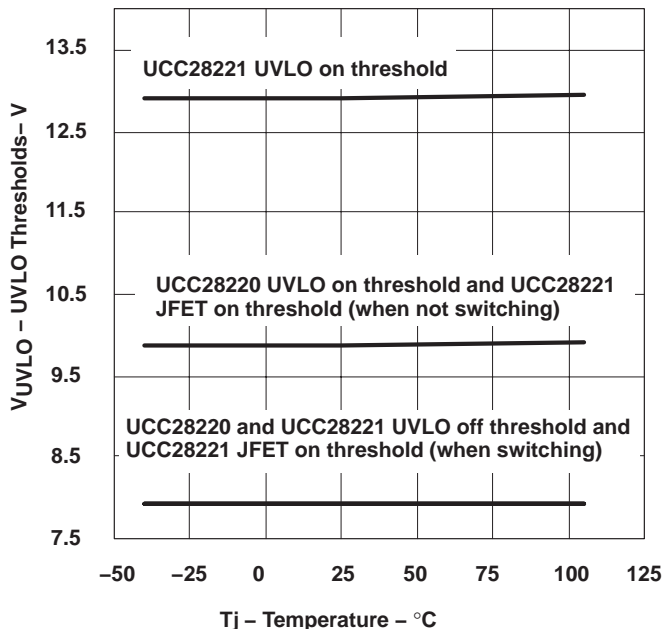

Figure 5

QUIESCENT CURRENT
vs
SUPPLY VOLTAGE

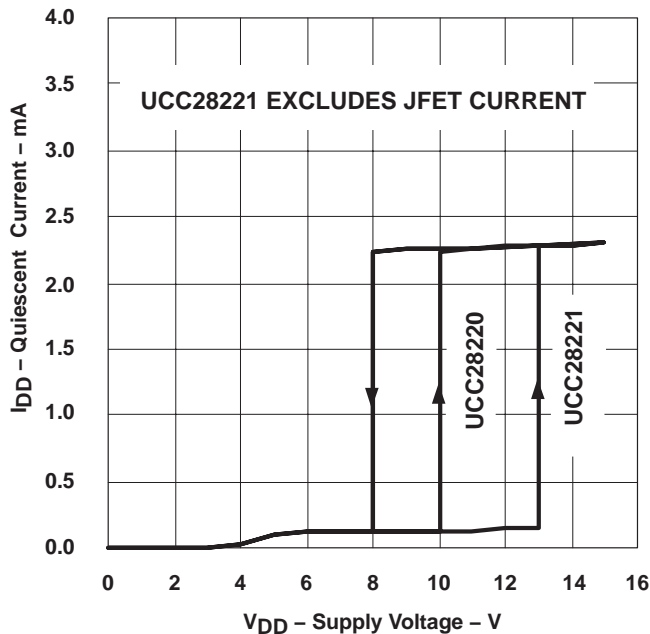

Figure 6

SUPPLY CURRENT
vs
SUPPLY VOLTAGE

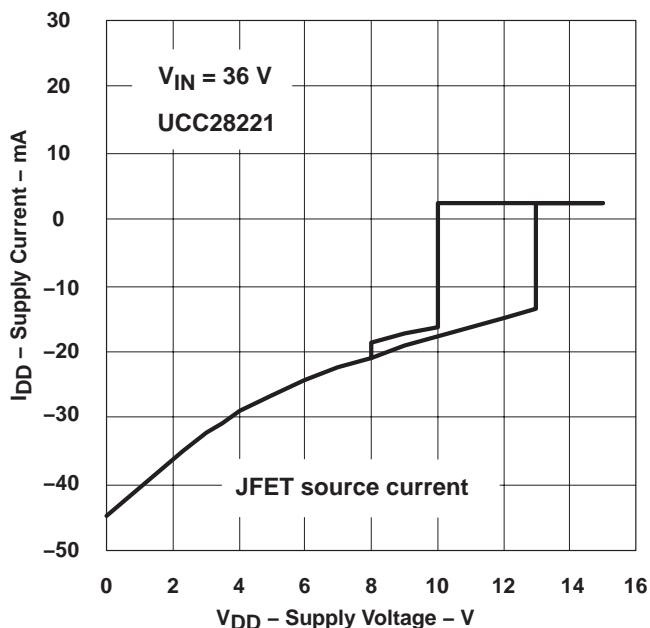

Figure 7

REFERENCE VOLTAGE
vs
TEMPERATURE

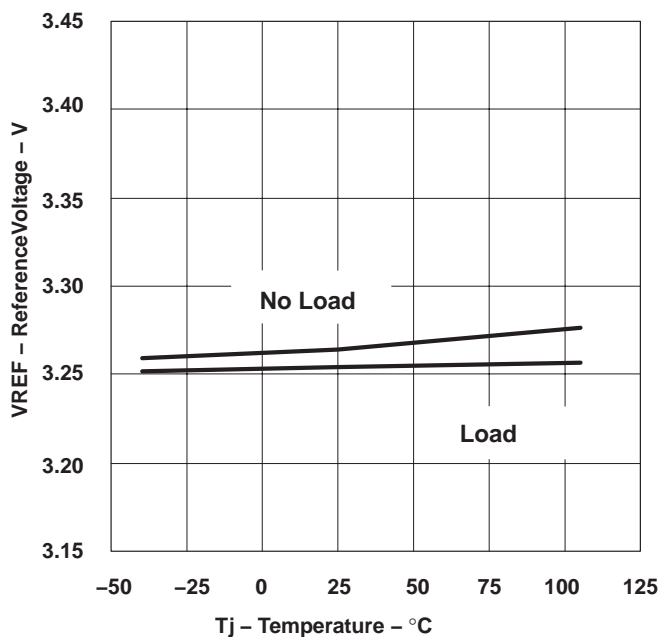

Figure 8

TYPICAL CHARACTERISTICS

REFERENCE VOLTAGE
VS
TEMPERATURE

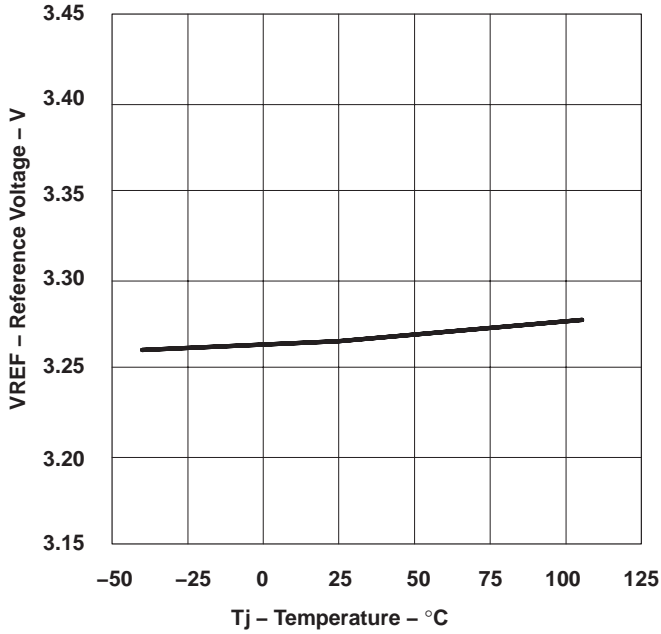

Figure 9

LINEOV AND LINEUV
VS
TEMPERATURE

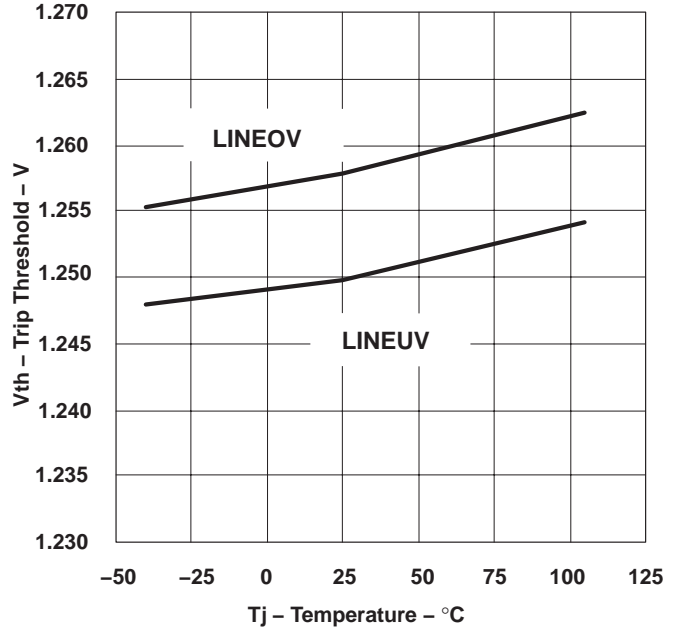

Figure 10

SLOPE COMPENSATION
VS
TEMPERATURE

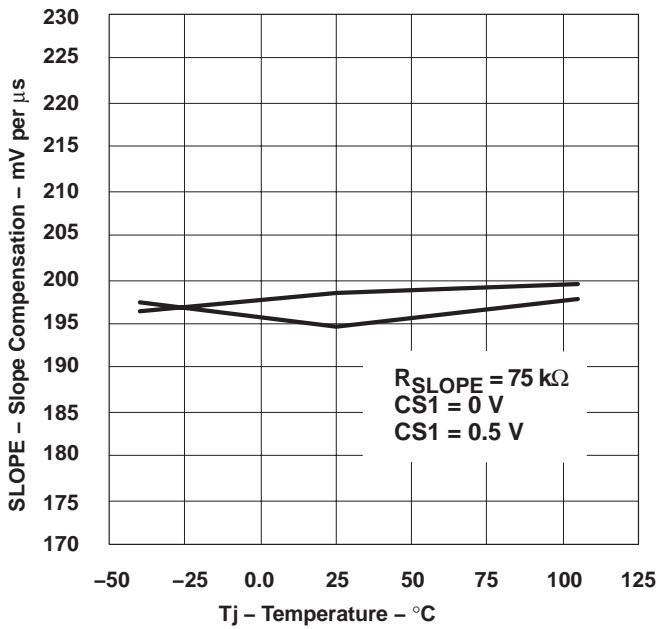

Figure 11

PROGRAMMING RESISTOR
VS
SLOPE COMPENSATION

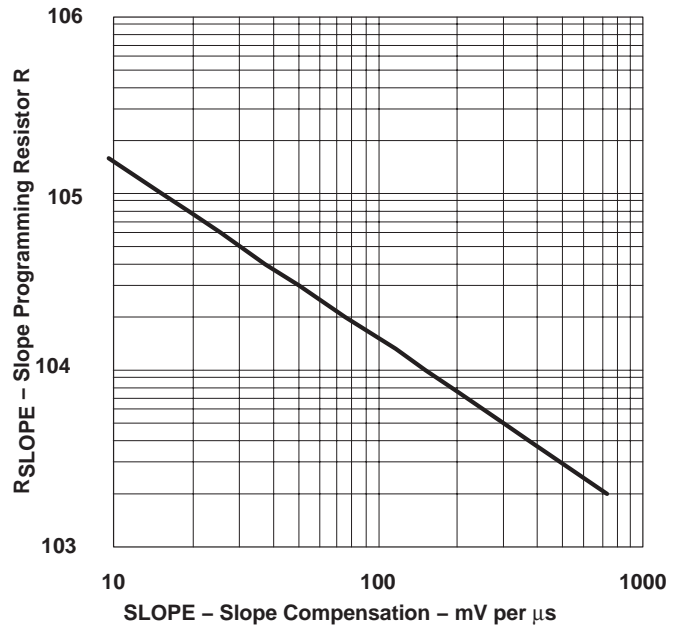

Figure 12

TYPICAL CHARACTERISTICS

CHANNEL1 AND CHANNEL2 SLOPE MATCHING
vs
TEMPERATURE

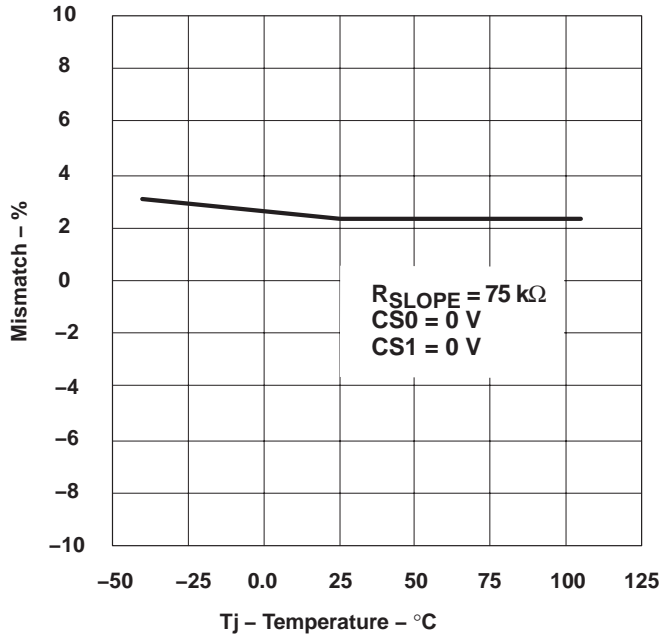

Figure 13

RISE AND FALL TIME
vs
TEMPERATURE (CL = 50 pf)

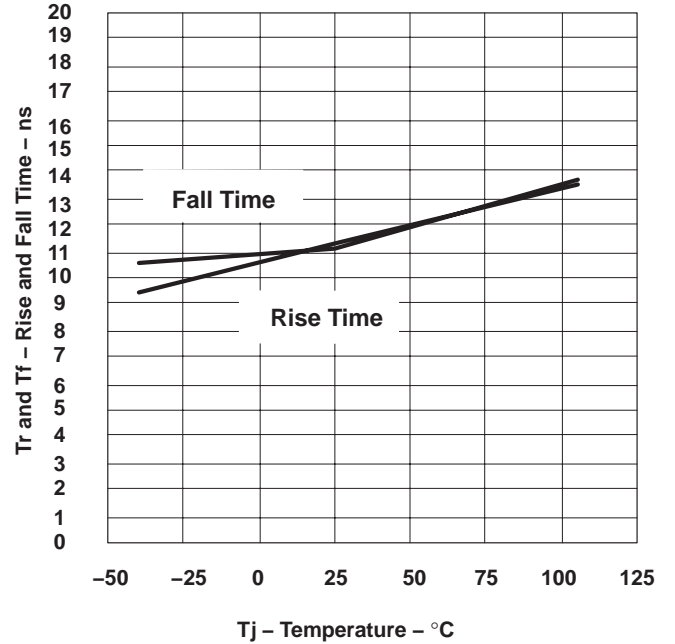

Figure 14

VOH AND VOL
vs
TEMPERATURE

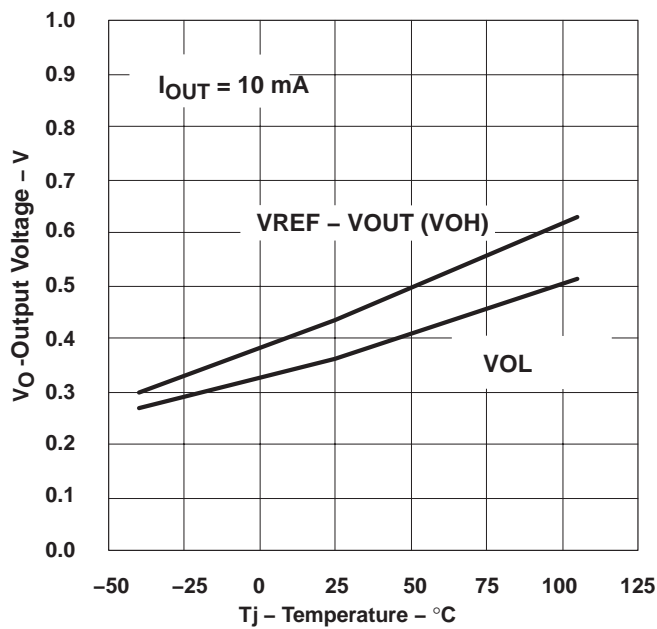

Figure 15

SOFTSTART CHARGE CURRENT
vs
TEMPERATURE

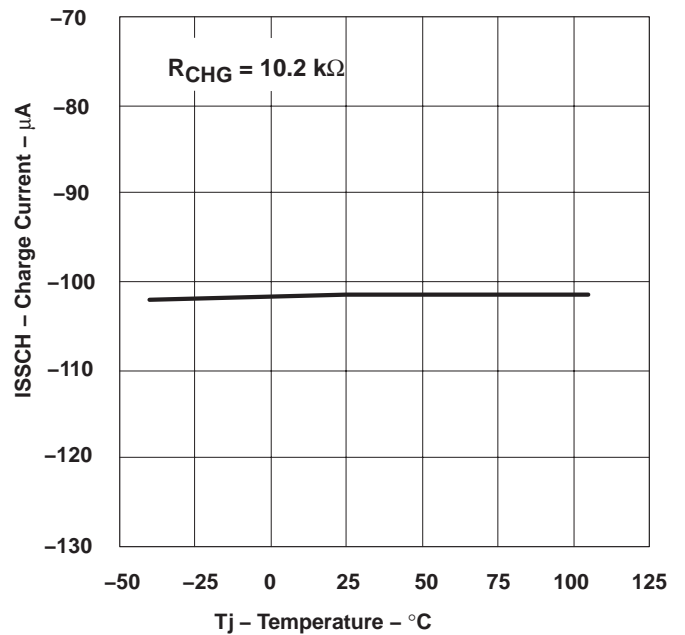

Figure 16

TYPICAL CHARACTERISTICS

SOFTSTART DISCHARGE CURRENT
vs
TEMPERATURE

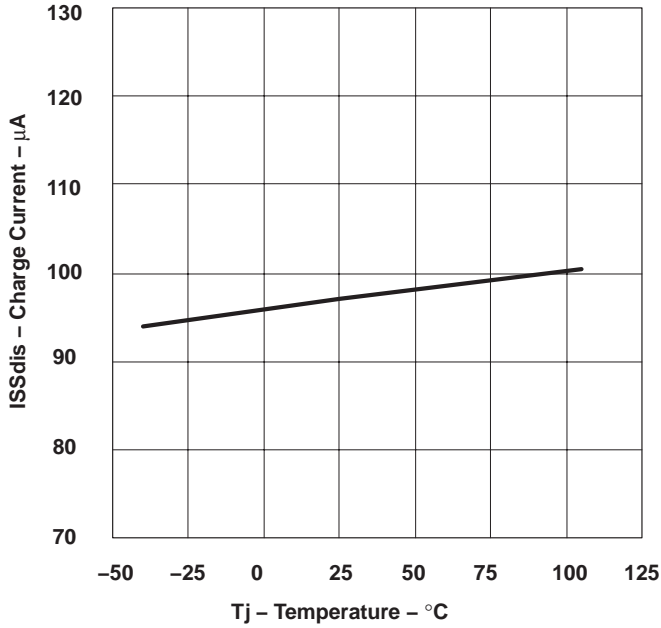

Figure 17

PROGRAMMING RESISTORS
vs
SWITCHING FREQUENCY

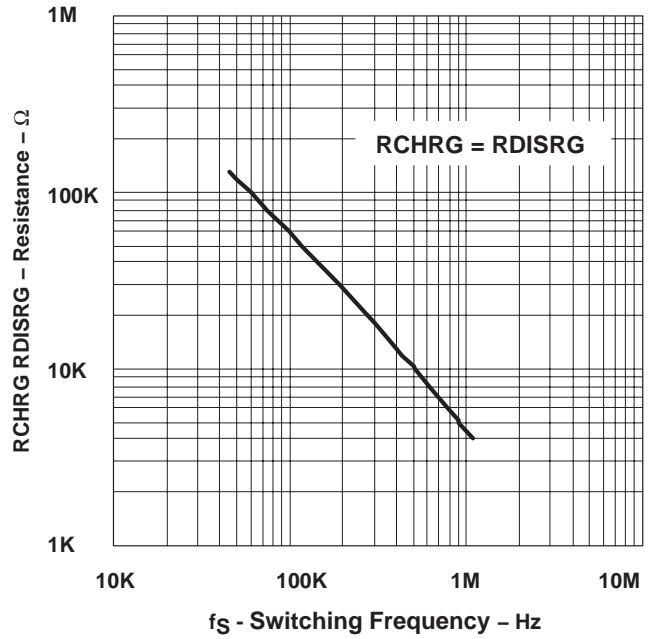

Figure 18

OSCILLATOR FREQUENCY
vs
TEMPERATURE

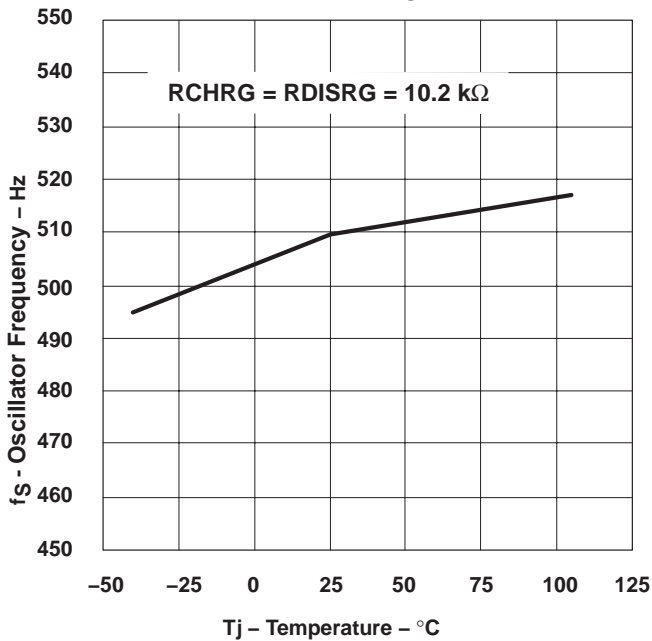

Figure 19

PROGRAMMABLE MAX DUTY CYCLE
vs
TEMPERATURE

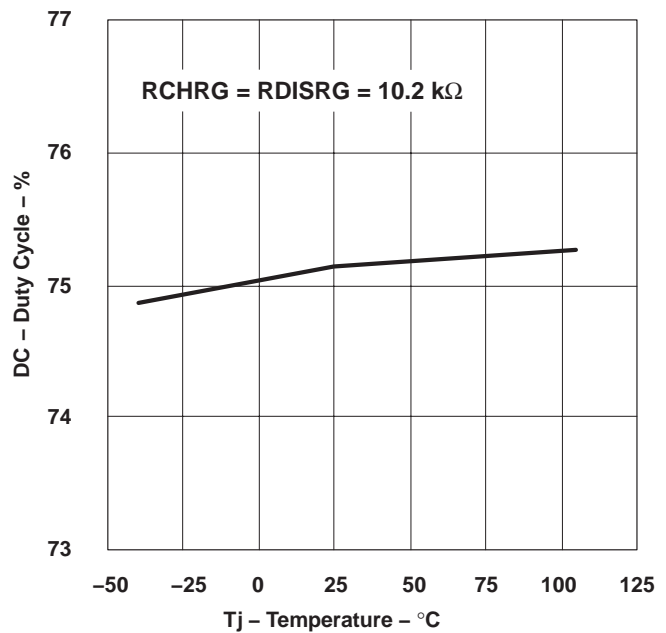

Figure 20

TYPICAL CHARACTERISTICS

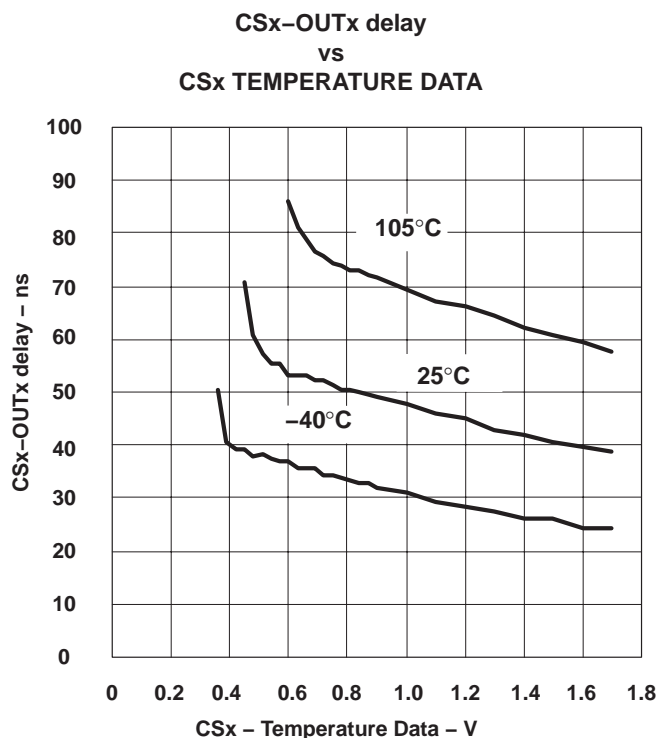

Figure 21

Related Products

DEVICE	DESCRIPTION	PACKAGE OPTION
UCC27323/4/5	Dual 4-A High Speed Low Side MOSFET Drivers	SOIC-8, PowerPAD MSOP-8, PDIP-8
UCC27423/4/5	Dual 4-A High Speed Low Side MOSFET Drivers with Enable	SOIC-8, PowerPAD MSOP-8, PDIP-8
TPS2811/12/13	Dual 2.4-A High Speed Low Side MOSFET Drivers	SOIC-8, TSSOP-8, PDIP-8

References and Resources:

An evaluation module and an associated user's guide are available. The UCC28221 is used in a two-channel interleaved Forward design converting from 36-V to 76-V dc input voltage to a regulated 12-V dc output. The power module has two isolated 100 W forward power stages operating at 500 kHz, which are operating 180 degrees out of phase with each other allowing for output current ripple cancellation and smaller magnetic design. This design also takes advantage of the UCC28221's on-board 110-V internal JFET start up circuit that removes the need of an external trickle charge resistor for boot strapping. This circuit turns off after auxiliary power is supplied to the device conserving power.

- Evaluation Module, *UCC28221EVM*, 48 V_{IN}, 12 V_{OUT}, 200-W Interleaved Forward Converter
- User's Guide, *UCC28221 Evaluation Module*, Texas Instruments Literature Number SLUU173

MECHANICAL DATA

D (R-PDSO-G**) PLASTIC SMALL-OUTLINE PACKAGE

8 PINS SHOWN

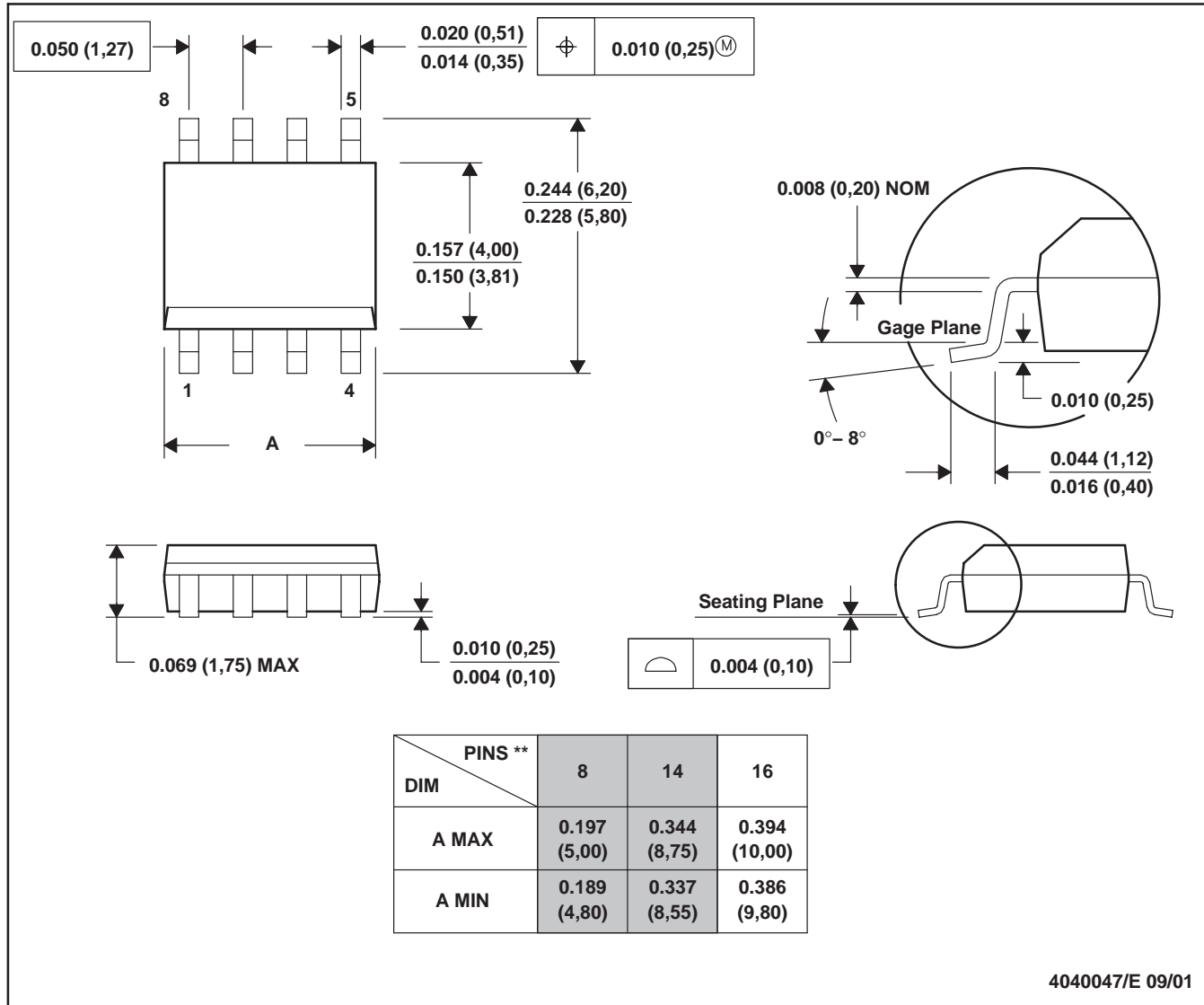

- NOTES: A. All linear dimensions are in inches (millimeters).
 B. This drawing is subject to change without notice.
 C. Body dimensions do not include mold flash or protrusion, not to exceed 0.006 (0,15).
 D. Falls within JEDEC MS-012

MECHANICAL DATA

PW (R-PDSO-G**) PACKAGE

PLASTIC SMALL-OUTLINE

14 PINS SHOWN

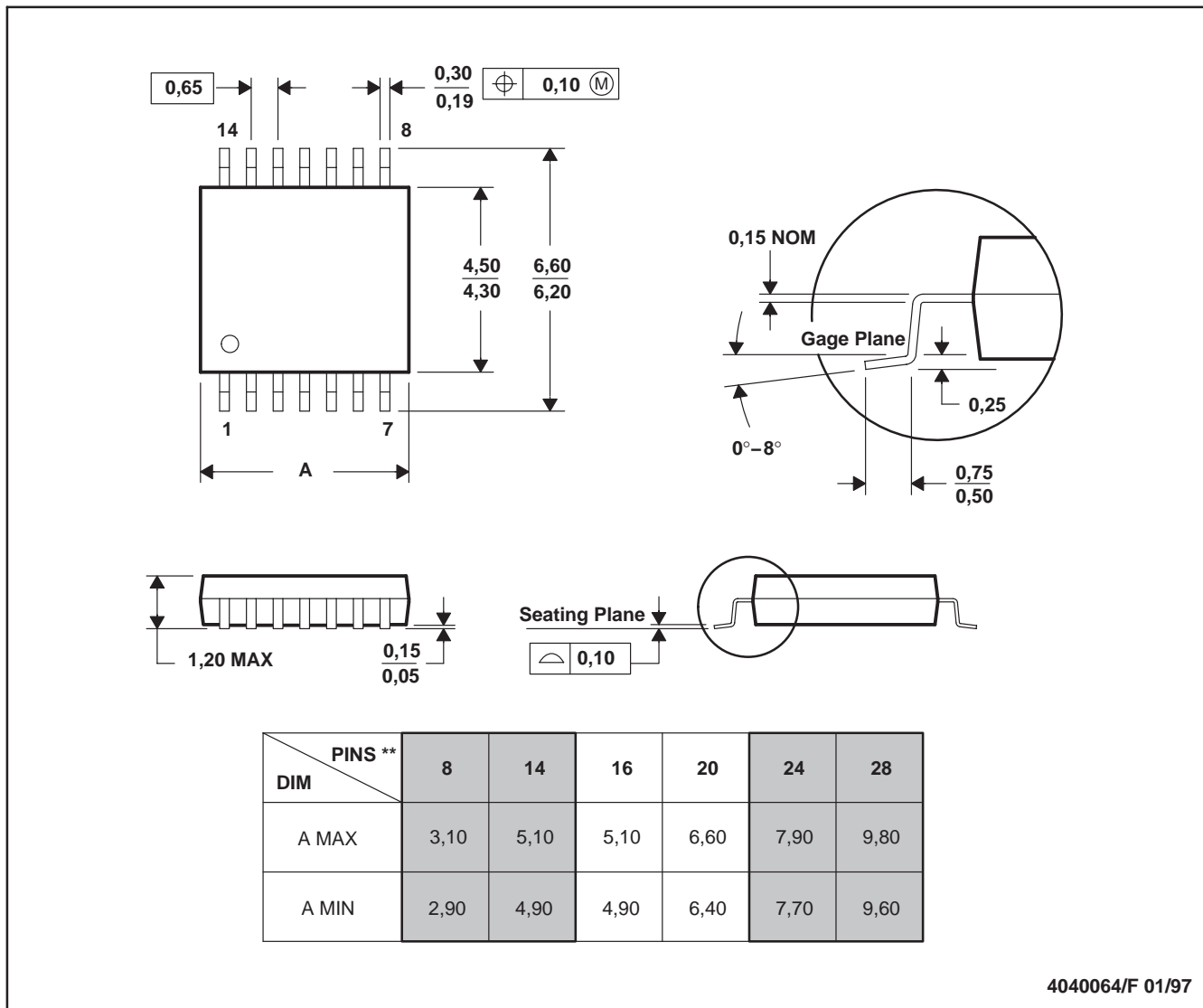

- NOTES: A. All linear dimensions are in millimeters.
 B. This drawing is subject to change without notice.
 C. Body dimensions do not include mold flash or protrusion not to exceed 0,15.
 D. Falls within JEDEC MO-153

IMPORTANT NOTICE

Texas Instruments Incorporated and its subsidiaries (TI) reserve the right to make corrections, modifications, enhancements, improvements, and other changes to its products and services at any time and to discontinue any product or service without notice. Customers should obtain the latest relevant information before placing orders and should verify that such information is current and complete. All products are sold subject to TI's terms and conditions of sale supplied at the time of order acknowledgment.

TI warrants performance of its hardware products to the specifications applicable at the time of sale in accordance with TI's standard warranty. Testing and other quality control techniques are used to the extent TI deems necessary to support this warranty. Except where mandated by government requirements, testing of all parameters of each product is not necessarily performed.

TI assumes no liability for applications assistance or customer product design. Customers are responsible for their products and applications using TI components. To minimize the risks associated with customer products and applications, customers should provide adequate design and operating safeguards.

TI does not warrant or represent that any license, either express or implied, is granted under any TI patent right, copyright, mask work right, or other TI intellectual property right relating to any combination, machine, or process in which TI products or services are used. Information published by TI regarding third-party products or services does not constitute a license from TI to use such products or services or a warranty or endorsement thereof. Use of such information may require a license from a third party under the patents or other intellectual property of the third party, or a license from TI under the patents or other intellectual property of TI.

Reproduction of information in TI data books or data sheets is permissible only if reproduction is without alteration and is accompanied by all associated warranties, conditions, limitations, and notices. Reproduction of this information with alteration is an unfair and deceptive business practice. TI is not responsible or liable for such altered documentation.

Resale of TI products or services with statements different from or beyond the parameters stated by TI for that product or service voids all express and any implied warranties for the associated TI product or service and is an unfair and deceptive business practice. TI is not responsible or liable for any such statements.

Following are URLs where you can obtain information on other Texas Instruments products and application solutions:

Products		Applications	
Amplifiers	amplifier.ti.com	Audio	www.ti.com/audio
Data Converters	dataconverter.ti.com	Automotive	www.ti.com/automotive
DSP	dsp.ti.com	Broadband	www.ti.com/broadband
Interface	interface.ti.com	Digital Control	www.ti.com/digitalcontrol
Logic	logic.ti.com	Military	www.ti.com/military
Power Mgmt	power.ti.com	Optical Networking	www.ti.com/opticalnetwork
Microcontrollers	microcontroller.ti.com	Security	www.ti.com/security
		Telephony	www.ti.com/telephony
		Video & Imaging	www.ti.com/video
		Wireless	www.ti.com/wireless

Mailing Address: Texas Instruments
Post Office Box 655303 Dallas, Texas 75265

Copyright © 2003, Texas Instruments Incorporated