

CD4512B Types

CMOS 8-Channel Data Selector

High-Voltage Types (20-Volt Rating)

■ CD4512B is an 8-channel data selector featuring a three-state output that can interface directly with, and drive, data lines of bus-oriented systems.

The CD4512B-series types are supplied in 16-lead hermetic dual-in-line ceramic packages (D and F suffixes), 16-lead dual-in-line plastic packages (E suffix), and in-chip form (H suffix).

Features:

- 3-state output
- Standardized, symmetrical output characteristics
- 100% tested for quiescent current at 20 V
- 5-V, 10-V, and 15-V parametric ratings
- Maximum input current of 1 μ A at 18 V over full package-temperature range; 100 nA at 18 V and 25°C
- Noise margin (over full package-temperature range):

1 V at $V_{DD} = 5$ V
2 V at $V_{DD} = 10$ V
2.5 V at $V_{DD} = 15$ V

- Meets all requirements of JEDEC Tentative Standard No. 13B, "Standard Specifications for Description of 'B' Series CMOS Devices"

Applications:

- Digital multiplexing
- Number-sequence generation
- Signal gating

RECOMMENDED OPERATING CONDITIONS

For maximum reliability, nominal operating conditions should be selected so that operation is always within the following ranges:

CHARACTERISTIC	LIMITS		UNITS
	MIN.	MAX.	
Supply-Voltage Range (For T_A = Full Package Temperature Range)	3	18	V

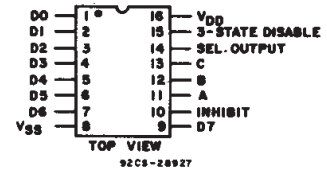
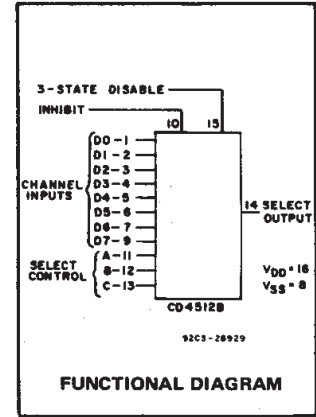

TERMINAL ASSIGNMENT

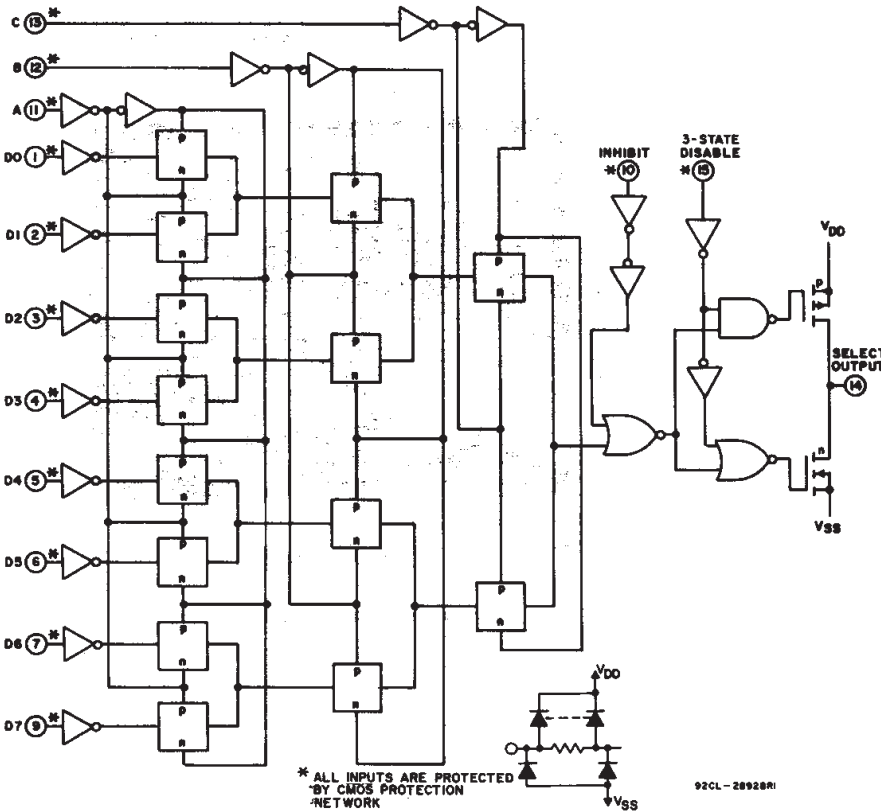

Fig. 1 - Logic diagram.

TRUTH TABLE

SEL. CONT.			INH	3-STATE DISABLE	SEL OUTPUT
A	B	C			
0	0	0	0	0	D0
1	0	0	0	0	D1
0	1	0	0	0	D2
1	1	0	0	0	D3
0	0	1	0	0	D4
1	0	1	0	0	D5
0	1	1	0	0	D6
1	1	1	0	0	D7
X	X	X	1	0	0
X	X	X	X	1	High Z

1 = High Level 0 = Low Level
X = Don't Care

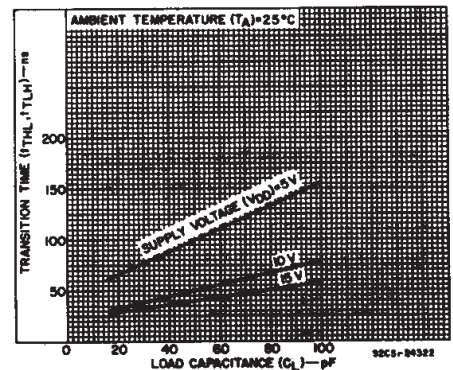

Fig. 2 - Typical transition time as a function of load capacitance.

CD4512B Types

MAXIMUM RATINGS, Absolute-Maximum Values:

DC SUPPLY-VOLTAGE RANGE, (V _{DD})	-0.5V to +20V
Voltages referenced to V _{SS} Terminal	-0.5V to V _{DD} +0.5V
INPUT VOLTAGE RANGE, ALL INPUTS	-0.5V to V _{DD} +0.5V
DC INPUT CURRENT, ANY ONE INPUT	±10mA
POWER DISSIPATION PER PACKAGE (P _D):	
For T _A = -55°C to +100°C	500mW
For T _A = +100°C to +125°C	Derate Linearly at 12mW/°C to 200mW
DEVICE DISSIPATION PER OUTPUT TRANSISTOR	
FOR T _A = FULL PACKAGE-TEMPERATURE RANGE (All Package Types)	100mW
OPERATING-TEMPERATURE RANGE (T _A)	-55°C to +125°C
STORAGE TEMPERATURE RANGE (T _{stg})	-65°C to +150°C
LEAD TEMPERATURE (DURING SOLDERING):	
At distance 1/16 ± 1/32 inch (1.59 ± 0.79mm) from case for 10s max	+265°C

STATIC ELECTRICAL CHARACTERISTICS

CHARACTERISTIC	CONDITIONS			LIMITS AT INDICATED TEMPERATURES (°C)							UNITS
	V _O (V)	V _{IN} (V)	V _{DD} (V)	-55	-40	+85	+125	+25			
								Min.	Typ.	Max.	
Quiescent Device Current, I _{DD} Max.	-	0,5	5	5	5	150	150	-	0.04	5	μA
	-	0,10	10	10	10	300	300	-	0.04	10	
	-	0,15	15	20	20	600	600	-	0.04	20	
	-	0,20	20	100	100	3000	3000	-	0.08	100	
Output Low (Sink) Current I _{OL} Min.	0.4	0,5	5	0.64	0.61	0.42	0.36	0.51	1	-	mA
	0.5	0,10	10	1.6	1.5	1.1	0.9	1.3	2.6	-	
	1.5	0,15	15	4.2	4	2.8	2.4	3.4	6.8	-	
Output High (Source) Current, I _{OH} Min.	4.6	0,5	5	-0.64	-0.61	-0.42	-0.36	-0.51	-1	-	mA
	2.5	0,5	5	-2	-1.8	-1.3	-1.15	-1.6	-3.2	-	
	9.5	0,10	10	-1.6	-1.5	-1.1	-0.9	-1.3	-2.6	-	
	13.5	0,15	15	-4.2	-4	-2.8	-2.4	-3.4	-6.8	-	
Output Voltage: Low-Level, V _{OL} Max.	-	0,5	5	0.05				-	0	0.05	V
	-	0,10	10	0.05				-	0	0.05	
	-	0,15	15	0.05				-	0	0.05	
Output Voltage: High-Level, V _{OH} Min.	-	0,5	5	4.95				4.95	5	-	V
	-	0,10	10	9.95				9.95	10	-	
	-	0,15	15	14.95				14.95	15	-	
Input Low Voltage V _{IL} Max.	0.5,4.5	-	5	1.5				-	-	1.5	V
	1.9	-	10	3				-	-	3	
	1.5,13.5	-	15	4				-	-	4	
Input High Voltage, V _{IH} Min.	0.5,4.5	-	5	3.5				3.5	-	-	V
	1.9	-	10	7				7	-	-	
	1.5,13.5	-	15	11				11	-	-	
Input Current I _{IN} Max.	-	0,18	18	±0.1	±0.1	±1	±1	-	±10 ⁻⁵	±0.1	μA
3-State Output Leakage Current I _{OUT} Max.	0,18	0,18	18	±0.4	±0.4	±12	±12	-	±10 ⁻⁴	±0.4	μA

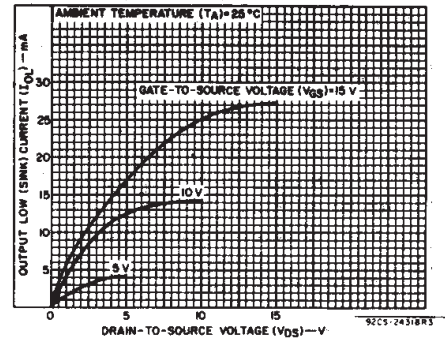

Fig. 3 - Typical output low (sink) current characteristics.

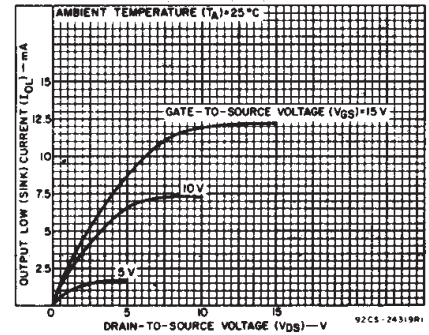

Fig. 4 - Minimum output low (sink) current characteristics.

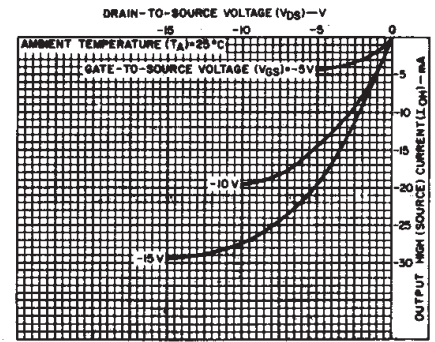

Fig. 5 - Typical output high (source) current characteristics.

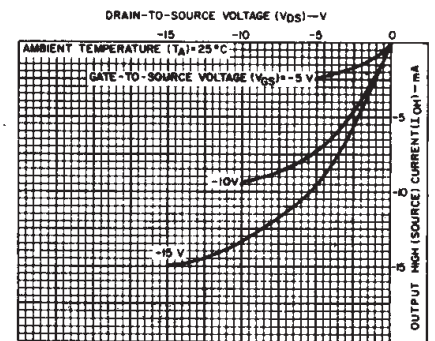

Fig. 6 - Minimum output high (source) current characteristics.

3
COMMERCIAL CMOS
HIGH VOLTAGE ICs

CD4512B Types

DYNAMIC ELECTRICAL CHARACTERISTICS at $T_A = 25^\circ\text{C}$, Input $t_r, t_f = 20\text{ ns}$, $C_L = 50\text{ pF}$, $R_L = 200\text{ k}\Omega$

CHARACTERISTIC	TEST CONDITIONS V_{DD} (V)	LIMITS		UNITS
		Typ.	Max.	
Propagation Delay Time, t_{PHL} , t_{PLH} Inhibit to Output	5	140	280	ns
	10	70	140	
	15	50	100	
"A" Select to Output	5	200	400	
	10	85	170	
	15	60	120	
Data to Output	5	180	360	
	10	75	150	
	15	55	110	
3-State Disable Delay Time: t_{PZL} , t_{PLZ} , t_{PHZ} , t_{PZH}	5	60	120	ns
	10	30	60	
	15	20	40	
Transition Time, t_{THL} , t_{TLH}	5	100	200	ns
	10	50	100	
	15	40	80	
Input Capacitance, C_{iN} (Any Input)		5	7.5	pF

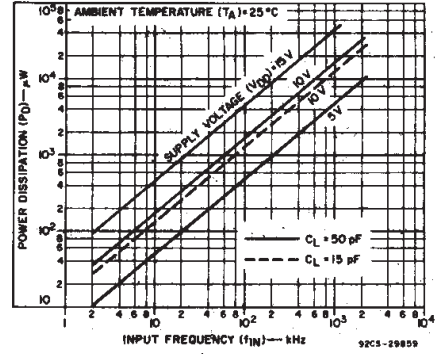

Fig. 7 - Typical dynamic power dissipation as a function of frequency.

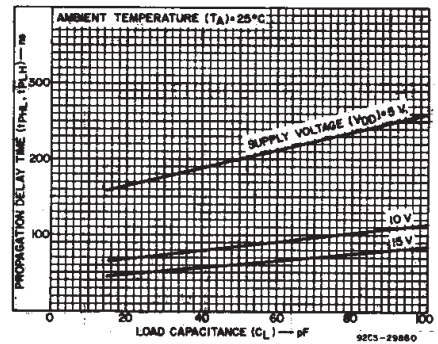

Fig. 8 - Typical propagation delay time as a function of load capacitance ("A" select to output).

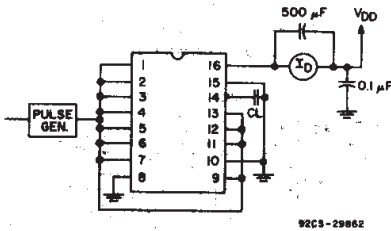

Fig. 9 - Dynamic power dissipation test circuit.

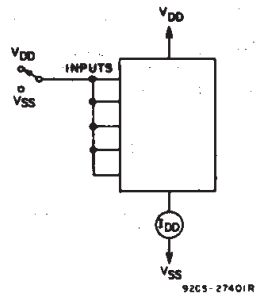

Fig. 10 - Quiescent device current test circuit.

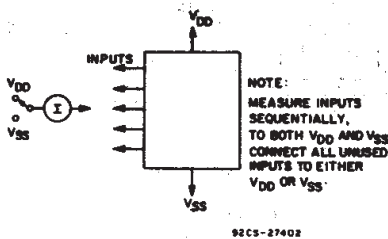

Fig. 11 - Input current test circuit.

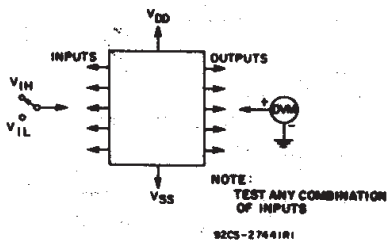
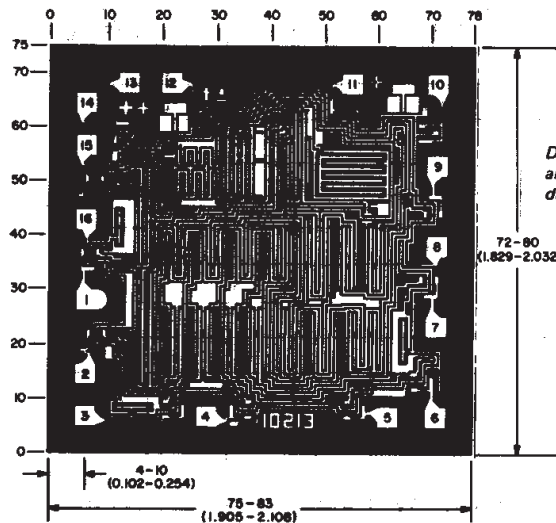

Fig. 12 - Input voltage test circuit.



Dimensions in parentheses are in millimeters and are derived from the basic inch dimensions as indicated. Grid graduations are in mils (10⁻³ inch).

Dimensions and pad layout for CD4512BH

IMPORTANT NOTICE

Texas Instruments and its subsidiaries (TI) reserve the right to make changes to their products or to discontinue any product or service without notice, and advise customers to obtain the latest version of relevant information to verify, before placing orders, that information being relied on is current and complete. All products are sold subject to the terms and conditions of sale supplied at the time of order acknowledgement, including those pertaining to warranty, patent infringement, and limitation of liability.

TI warrants performance of its semiconductor products to the specifications applicable at the time of sale in accordance with TI's standard warranty. Testing and other quality control techniques are utilized to the extent TI deems necessary to support this warranty. Specific testing of all parameters of each device is not necessarily performed, except those mandated by government requirements.

CERTAIN APPLICATIONS USING SEMICONDUCTOR PRODUCTS MAY INVOLVE POTENTIAL RISKS OF DEATH, PERSONAL INJURY, OR SEVERE PROPERTY OR ENVIRONMENTAL DAMAGE ("CRITICAL APPLICATIONS"). TI SEMICONDUCTOR PRODUCTS ARE NOT DESIGNED, AUTHORIZED, OR WARRANTED TO BE SUITABLE FOR USE IN LIFE-SUPPORT DEVICES OR SYSTEMS OR OTHER CRITICAL APPLICATIONS. INCLUSION OF TI PRODUCTS IN SUCH APPLICATIONS IS UNDERSTOOD TO BE FULLY AT THE CUSTOMER'S RISK.

In order to minimize risks associated with the customer's applications, adequate design and operating safeguards must be provided by the customer to minimize inherent or procedural hazards.

TI assumes no liability for applications assistance or customer product design. TI does not warrant or represent that any license, either express or implied, is granted under any patent right, copyright, mask work right, or other intellectual property right of TI covering or relating to any combination, machine, or process in which such semiconductor products or services might be or are used. TI's publication of information regarding any third party's products or services does not constitute TI's approval, warranty or endorsement thereof.