

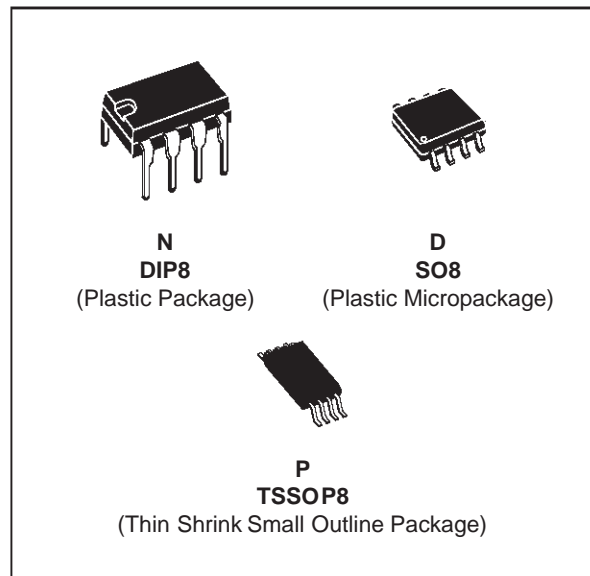

# TS921

## RAIL TO RAIL HIGH OUTPUT CURRENT SINGLE OPERATIONAL AMPLIFIER

- RAIL TO RAIL INPUT AND OUTPUT
- LOW NOISE :  $9\text{nV}/\sqrt{\text{Hz}}$
- LOW DISTORTION
- HIGH OUTPUT CURRENT : **80mA**  
(able to drive  $32\Omega$  loads)
- HIGH SPEED : **4MHz, 1.3V/ $\mu\text{s}$**
- OPERATING FROM **2.7V to 12V**
- ESD INTERNAL PROTECTION : 1.5KV
- LATCH-UP IMMUNITY
- MACROMODEL INCLUDED IN THIS SPECIFICATION



### DESCRIPTION

The TS921 is a RAIL TO RAIL single BiCMOS operational amplifier optimized and fully specified for 3V and 5V operation.

High output current allows low load impedances to be driven.

The TS921 exhibits a very low noise, low distortion, low offset and high output current capability making this device an excellent choice for high quality, low voltage or battery operated audio systems.

The device is stable for capacitive loads up to 500pF.

### APPLICATIONS

- headphone amplifier
- piezoelectric speaker driver
- sound cards, multimedia systems
- line driver, actuator driver
- servo amplifier
- mobile phone and portable communication sets
- instrumentation with low noise as a key factor

### ORDER CODES

Part Number	Temperature Range	Package		
		N	D	P
TS921I	-40, +125°C	•	•	•

### PIN CONNECTIONS (top view)

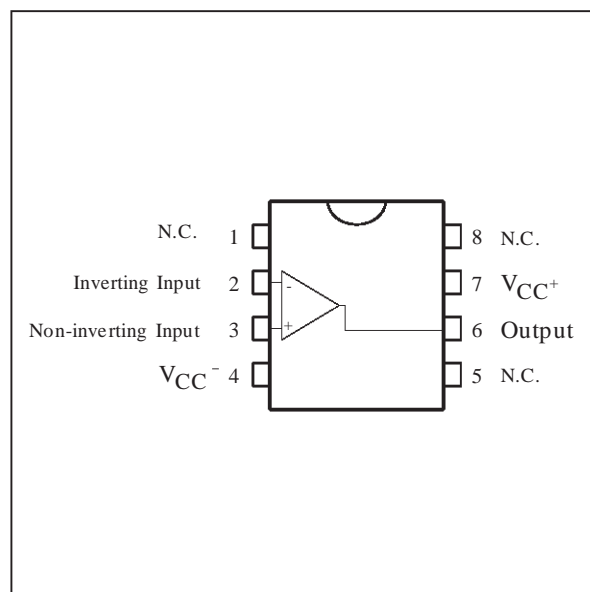

**ABSOLUTE MAXIMUM RATINGS**

Symbol	Parameter	Value	Unit
$V_{CC}$	Supply Voltage - (note 1)	12	V
$V_{id}$	Differential Input Voltage - (note 2)	$\pm 1$	V
$V_i$	Input Voltage - (note 3)	-0.3 to 14	V
$T_{oper}$	Operating Free Air Temperature Range	-40 to +125	$^{\circ}\text{C}$
$T_{stg}$	Storage Temperature	-65 to +150	$^{\circ}\text{C}$
$T_j$	Maximum Junction Temperature	150	$^{\circ}\text{C}$
	Output Short Circuit Duration	see note 4	$^{\circ}\text{C}$

**Notes :**

1. All voltage values, except differential voltage are with respect to network ground terminal.
2. Differential voltages are the non-inverting input terminal with respect to the inverting input terminal.
3. The magnitude of input and output voltages must never exceed  $V_{CC}^{+} + 0.3\text{V}$ .
4. Short-circuits can cause excessive heating.

**OPERATING CONDITIONS**

Symbol	Parameter	Value	Unit
$V_{CC}$	Supply Voltage	2.7 to 12	V
$V_{icm}$	Common Mode Input Voltage Range	$V_{CC}^{-} - 0.2$ to $V_{CC}^{+} + 0.2$	V

**ELECTRICAL CHARACTERISTICS**

$V_{CC}^+ = 3V$ ,  $T_{amb} = 25^{\circ}C$  (unless otherwise specified)

Symbol	Parameter	Min.	Typ.	Max.	Unit
$V_{io}$	Input Offset Voltage $T_{min.} \leq T_{amb} \leq T_{max.}$			3 5	mV
$DV_{io}$	Input Offset Voltage Drift		2		$\mu V/^{\circ}C$
$i_{io}$	Input Offset Current $V_{out} = 1.5V$			30	nA
$i_{ib}$	Input Bias Current $V_{out} = 1.5V$		15	100	nA
$V_{OH}$	High Level Output Voltage $R_L = 600\Omega$ $R_L = 32\Omega$	2.87	2.63		V
$V_{OL}$	Low Level Output Voltage $R_L = 600\Omega$ $R_L = 32\Omega$		180	100	mV
$A_{vd}$	Large Signal Voltage Gain ( $V_{out} = 2V_{pk-pk}$ ) $R_L = 600\Omega$ $R_L = 32\Omega$		35 16		V/mV
$I_{CC}$	Supply Current no load, $V_{out} = V_{CC}/2$		1	1.5	mA
GBP	Gain Bandwidth Product $R_L = 600\Omega$		4		MHz
CMR	Common Mode Rejection Ratio	60	80		dB
SVR	Supply Voltage Rejection Ratio $V_{CC} = 2.7$ to $3.3V$	60	80		dB
$I_o$	Output Short Circuit Current	50	80		mA
SR	Slew Rate	0.7	1.3		V/ $\mu s$
$\phi_m$	Phase Margin at Unity Gain $R_L = 600\Omega, C_L = 100pF$		68		Degrees
$G_m$	Gain Margin $R_L = 600\Omega, C_L = 100pF$		12		dB
$e_n$	Equivalent Input Noise Voltage $f = 1kHz$		9		$\frac{nV}{\sqrt{Hz}}$
THD	Total Harmonic Distortion $V_{out} = 2V_{pk-pk}, F = 1kHz, A_V = 1, R_L = 600\Omega$		0.005		%

**ELECTRICAL CHARACTERISTICS**

$V_{CC}^+ = 5V$ ,  $T_{amb} = 25^{\circ}C$  (unless otherwise specified)

Symbol	Parameter	Min.	Typ.	Max.	Unit
$V_{io}$	Input Offset Voltage $T_{min.} \leq T_{amb} \leq T_{max.}$			3 5	mV
$DV_{io}$	Input Offset Voltage Drift		2		$\mu V/^{\circ}C$
$i_{io}$	Input Offset Current $V_{out} = 1.5V$			30	nA
$i_{ib}$	Input Bias Current $V_{out} = 1.5V$		15	100	nA
$V_{OH}$	High Level Output Voltage $R_L = 600\Omega$ $R_L = 32\Omega$	4.85	4.4		V
$V_{OL}$	Low Level Output Voltage $R_L = 600\Omega$ $R_L = 32\Omega$		300	120	mV
$A_{vd}$	Large Signal Voltage Gain ( $V_{out} = 2V_{pk-pk}$ ) $R_L = 600\Omega$ $R_L = 32\Omega$		35 16		V/mV
$I_{CC}$	Supply Current no load, $V_{out} = V_{CC}/2$		1	1.5	mA
GBP	Gain Bandwidth Product $R_L = 600\Omega$		4		MHz
CMR	Common Mode Rejection Ratio	60	80		dB
SVR	Supply Voltage Rejection Ratio $V_{CC} = 2.7$ to $3.3V$	60	80		dB
$I_o$	Output Short Circuit Current	50	80		mA
SR	Slew Rate	0.7	1.3		V/ $\mu s$
$\phi_m$	Phase Margin at Unity Gain $R_L = 600\Omega, C_L = 100pF$		68		Degrees
$G_m$	Gain Margin $R_L = 600\Omega, C_L = 100pF$		12		dB
$e_n$	Equivalent Input Noise Voltage $f = 1kHz$		9		$\frac{nV}{\sqrt{Hz}}$
THD	Total Harmonic Distortion $V_{out} = 2V_{pk-pk}, F = 1kHz, A_V = 1, R_L = 600\Omega$		0.005		%

**MACROMODEL**

- RAIL TO RAIL INPUT AND OUTPUT
- LOW NOISE : **9nV/√Hz**
- LOW DISTORTION

- HIGH OUTPUT CURRENT : **80mA**  
(able to drive **32Ω** loads)
- HIGH SPEED : **4MHz, 1.3V/μs**
- OPERATING FROM **2.7V TO 12V**

\*\* StandardLinear Ics Macromodels, 1996.

\*\* CONNECTIONS :

- \* 1 INVERTING INPUT
- \* 2 NON-INVERTING INPUT
- \* 3 OUTPUT
- \* 4 POSITIVE POWER SUPPLY
- \* 5 NEGATIVE POWER SUPPLY

.SUBCKT TS921 1 3 2 4 5 (analog)  
\*\*\*\*\*

.MODEL MDTH D IS=1E-8 KF=2.664234E-16  
CJO=10F

\* INPUT STAGE

CIP 2 5 1.000000E-12

CIN 1 5 1.000000E-12

EIP 10 5 2 5 1

EIN 16 5 1 5 1

RIP 10 11 8.125000E+00

RIN 15 16 8.125000E+00

RIS 11 15 2.238465E+02

DIP 11 12 MDTH 400E-12

DIN 15 14 MDTH 400E-12

VOFP 12 13 DC 153.5u

VOFN 13 14 DC 0

IPOL 13 5 3.200000E-05

CPS 11 15 1e-9

DINN 17 13 MDTH 400E-12

VIN 17 5 -0.100000e+00

DINR 15 18 MDTH 400E-12

VIP 4 18 0.400000E+00

FCP 4 5 VOFP 1.865000E+02

FCN 5 4 VOFN 1.865000E+02

FIBP 2 5 VOFP 6.250000E-03

FIBN 5 1 VOFN 6.250000E-03

\* GM1 STAGE \*\*\*\*\*

FGM1P 119 5 VOFP 1.1

FGM1N 119 5 VOFN 1.1

RAP 119 4 2.6E+06

RAN 119 5 2.6E+06

\* GM2 STAGE \*\*\*\*\*

G2P 19 5 119 5 1.92E-02

G2N 19 5 119 4 1.92E-02

R2P 19 4 1E+07

R2N 19 5 1E+07

\*\*\*\*\*

VINT1 500 0 5

GCONVP 500 501 119 4 19.38 !envoi ds VP,  
I(VP)=(V119-V4)/2/Ut VP 501 0 0

GCONVN 500 502 119 5 19.38 !envoi ds VN,  
I(VN)=(V119-V5)/2/Ut VN 502 0 0

\*\*\*\*\* orientation isink isource \*\*\*\*\*

VINT2 503 0 5

FCOPY 503 504 VOUT 1

DCOPYP 504 505 MDTH 400E-9

VCOPYP 505 0 0

DCOPYN 506 504 MDTH 400E-9

VCOPYN 0 506 0

\*\*\*\*\*

F2PP 19 5 poly(2) VCOPYP VP 0 0 0 0.5 !multiplie  
I(vout)\*I(VP)=Iout\*(V119-V4)/2/Ut

F2PN 19 5 poly(2) VCOPYP VN 0 0 0 0.5  
!multiplie I(vout)\*I(VN)=Iout\*(V119-V5)/2/Ut

F2NP 19 5 poly(2) VCOPYN VP 0 0 0 0 1.75  
!multiplie I(vout)\*I(VP)=Iout\*(V119-V4)/2/Ut

F2NN 19 5 poly(2) VCOPYN VN 0 0 0 0 1.75  
!multiplie I(vout)\*I(VN)=Iout\*(V119-V5)/2/Ut

\* COMPENSATION \*\*\*\*\*

CC 19 119 25p

\* OUTPUT\*\*\*\*\*

DOPM 19 22 MDTH 400E-12

DONM 21 19 MDTH 400E-12

HOPM 22 28 VOUT 6.250000E+02

VIPM 28 4 5.000000E+01

HONM 21 27 VOUT 6.250000E+02

VINM 5 27 5.000000E+01

VOUT 3 23 0

ROUT 23 19 6

COUT 3 5 1.300000E-10

DOP 19 25 MDTH 400E-12

VOP 4 25 1.052

DON 24 19 MDTH 400E-12

VON 24 5 1.052

.ENDS

**ELECTRICAL CHARACTERISTICS**

$V_{CC}^+ = 3V$ ,  $V_{CC}^- = 0V$ ,  $R_L, C_L$  connected to  $V_{CC}/2$ ,  $T_{amb} = 25^\circ C$   
(unless otherwise specified)

Symbol	Conditions	Value	Unit
$V_{io}$		0	mV
$A_{vd}$	$R_L = 10k\Omega$	200	V/mV
$I_{CC}$	No load, per operator	1.2	mA
$V_{icm}$		-0.2 to 3.2	V
$V_{OH}$	$R_L = 10k\Omega$	2.95	V
$V_{OL}$	$R_L = 10k\Omega$	25	mV
$I_{sink}$	$V_O = 3V$	80	mA
$I_{source}$	$V_O = 0V$	80	mA
GBP	$R_L = 600\Omega$	4	MHz
SR	$R_L = 10k\Omega$ , $C_L = 100pF$	1.3	V/ $\mu s$
$\varnothing m$	$R_L = 600\Omega$	68	Degrees

**OUTPUT SHORT CIRCUIT CURRENT vs OUTPUT VOLTAGE**

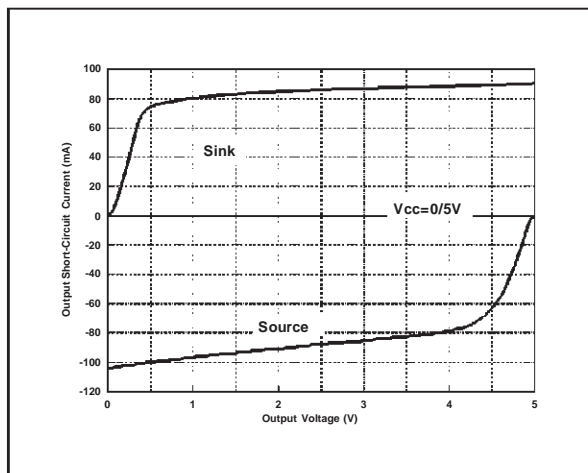

**OUTPUT SHORT CIRCUIT CURRENT vs OUTPUT VOLTAGE**

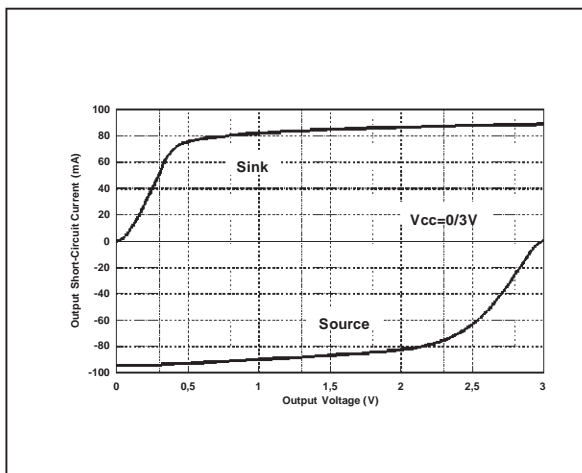

**TOTAL SUPPLY CURRENT vs SUPPLY VOLTAGE**

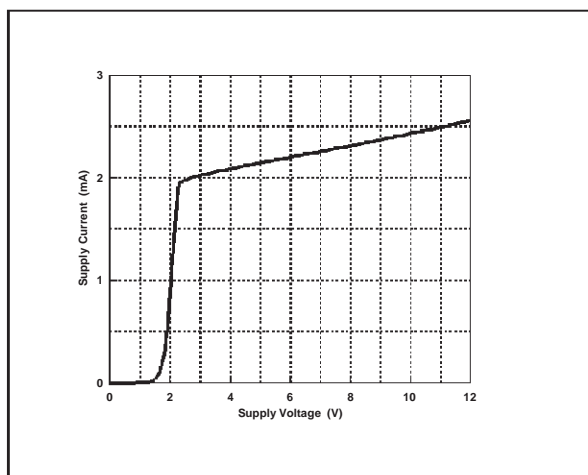

**VOLTAGE GAIN AND PHASE vs FREQUENCY**

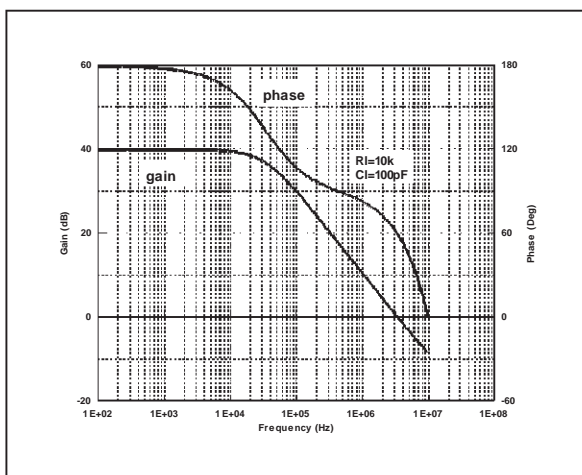

**EQUIVALENT INPUT NOISE VOLTAGE vs FREQUENCY**

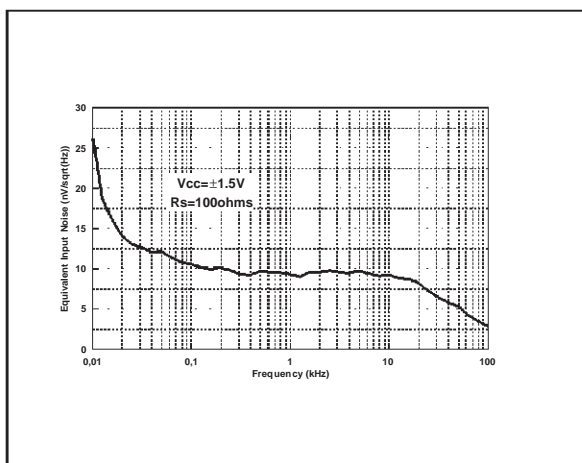

THD + NOISE vs FREQUENCY

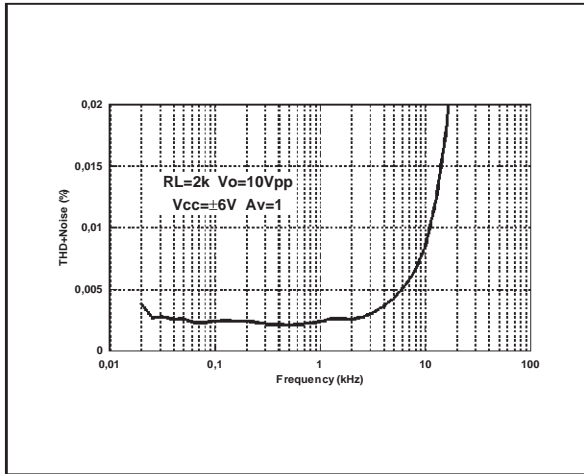

THD + NOISE vs FREQUENCY

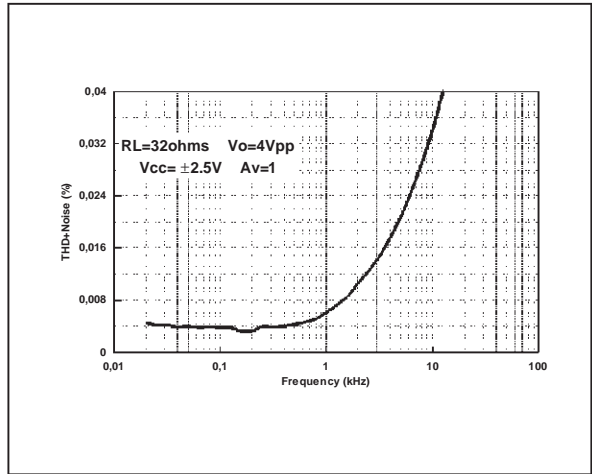

THD + NOISE vs FREQUENCY

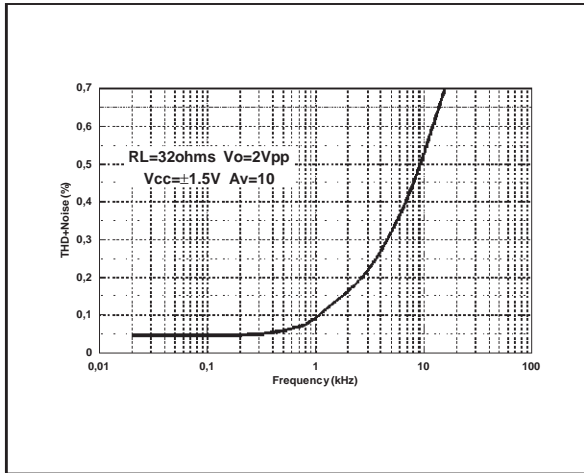

THD + NOISE vs OUTPUT VOLTAGE

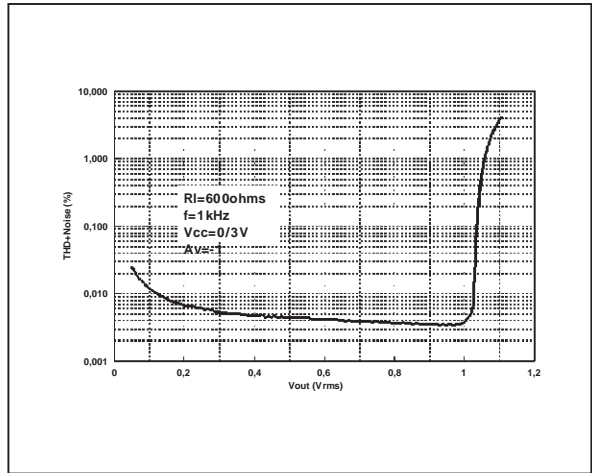

THD + NOISE vs OUTPUT VOLTAGE

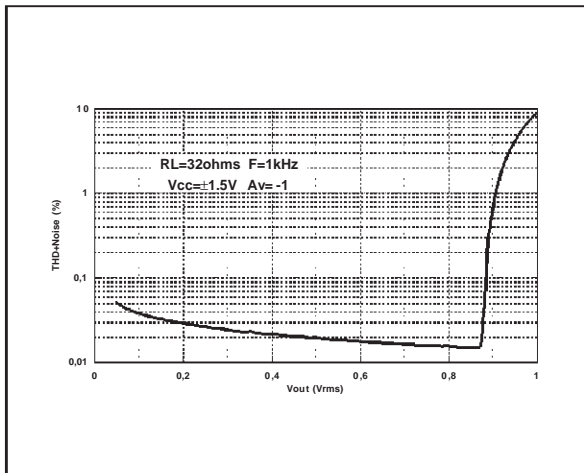

THD + NOISE vs OUTPUT VOLTAGE

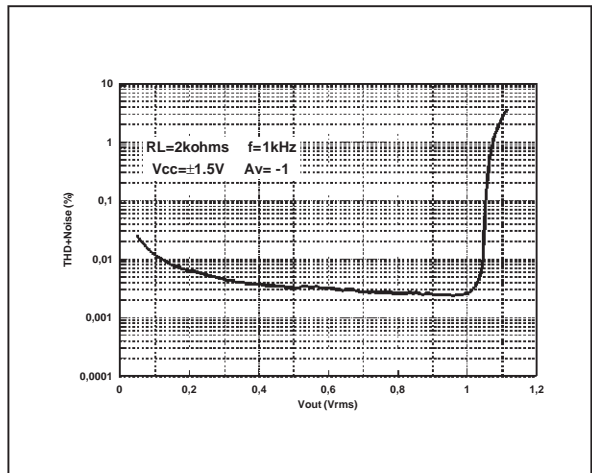



**PACKAGE MECHANICAL DATA**  
8 PINS - PLASTIC PACKAGE

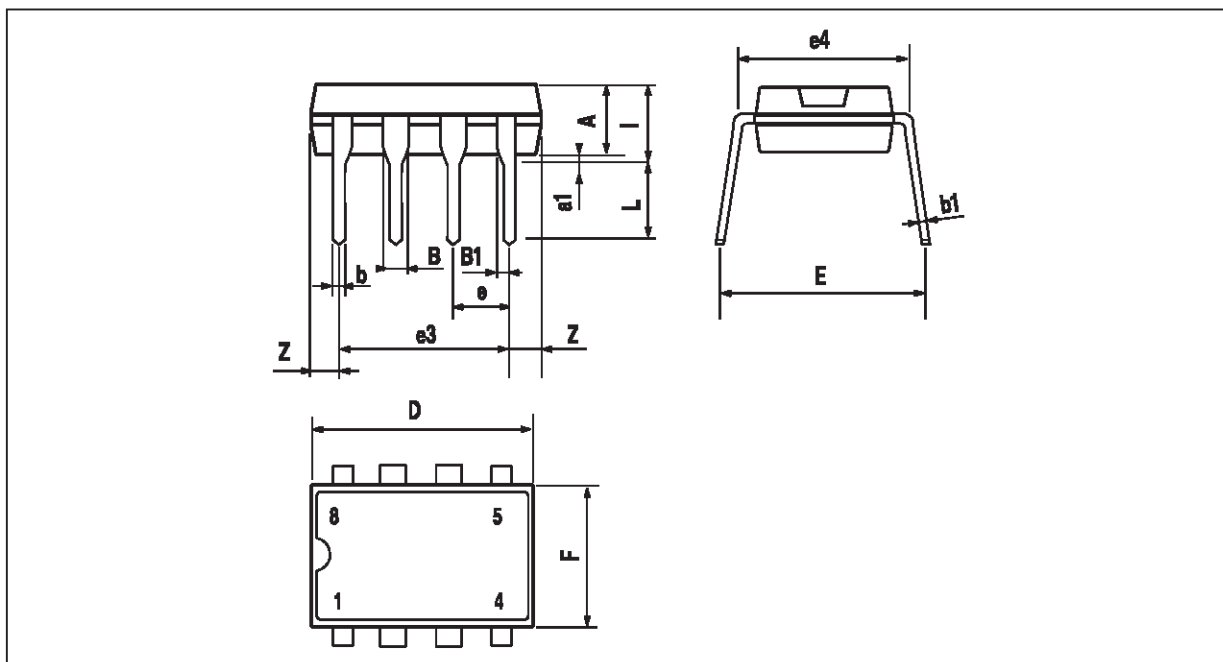

Dimensions	Millimeters			Inches		
	Min.	Typ.	Max.	Min.	Typ.	Max.
A		3.32			0.131	
a1	0.51			0.020		
B	1.15		1.65	0.045		0.065
b	0.356		0.55	0.014		0.022
b1	0.204		0.304	0.008		0.012
D			10.92			0.430
E	7.95		9.75	0.313		0.384
e		2.54			0.100	
e3		7.62			0.300	
e4		7.62			0.300	
F			6.6			0.260
i			5.08			0.200
L	3.18		3.81	0.125		0.150
Z			1.52			0.060

**PACKAGE MECHANICAL DATA**  
 8 PINS - PLASTIC MICROPACKAGE (SO)

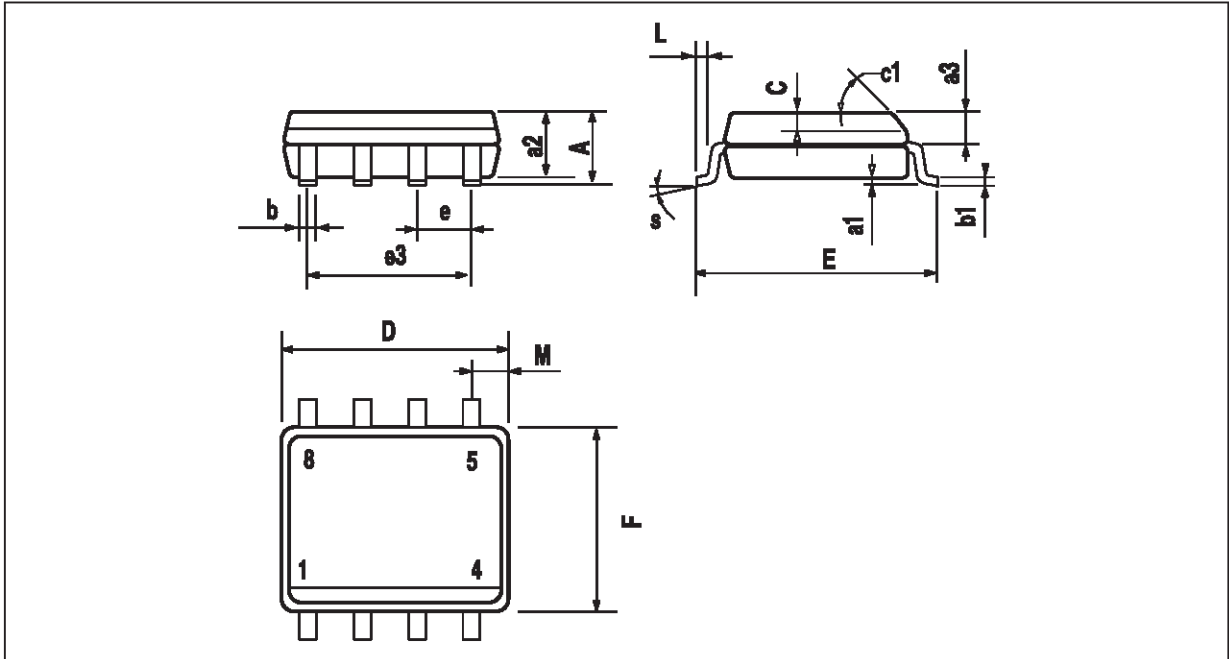

Dimensions	Millimeters			Inches		
	Min.	Typ.	Max.	Min.	Typ.	Max.
A			1.75			0.069
a1	0.1		0.25	0.004		0.010
a2			1.65			0.065
a3	0.65		0.85	0.026		0.033
b	0.35		0.48	0.014		0.019
b1	0.19		0.25	0.007		0.010
C	0.25		0.5	0.010		0.020
c1	45° (typ.)					
D	4.8		5.0	0.189		0.197
E	5.8		6.2	0.228		0.244
e		1.27			0.050	
e3		3.81			0.150	
F	3.8		4.0	0.150		0.157
L	0.4		1.27	0.016		0.050
M			0.6			0.024
S	8° (max.)					

**PACKAGE MECHANICAL DATA**  
**8 PINS - THIN SHRINK SMALL OUTLINE PACKAGE**

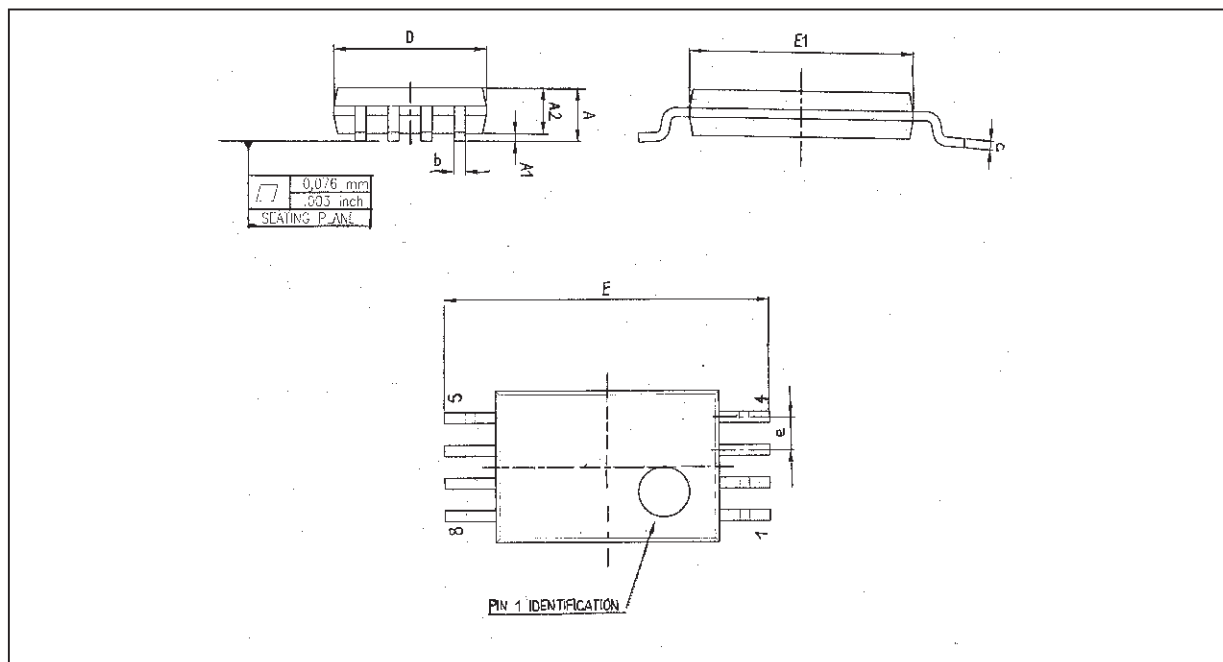

Dim.	Millimeters			Inches		
	Min.	Typ.	Max.	Min.	Typ.	Max.
A			1.20			0.05
A1	0.05		0.15	0.01		0.006
A2	0.80	1.00	1.05	0.031	0.039	0.041
b	0.19		0.30	0.007		0.15
c	0.09		0.20	0.003		0.012
D	2.90	3.00	3.10	0.114	0.118	0.122
E		6.40			0.252	
E1	4.30	4.40	4.50	0.169	0.173	0.177
e		0.65			0.025	
k	0°		8°	0°		8°
l	0.50	0.60	0.75	0.09	0.0236	0.030

Information furnished is believed to be accurate and reliable. However, STMicroelectronics assumes no responsibility for the consequences of use of such information nor for any infringement of patents or other rights of third parties which may result from its use. No license is granted by implication or otherwise under any patent or patent rights of STMicroelectronics. Specifications mentioned in this publication are subject to change without notice. This publication supersedes and replaces all information previously supplied. STMicroelectronics products are not authorized for use as critical components in life support devices or systems without express written approval of STMicroelectronics.

© The ST logo is a trademark of STMicroelectronics

© 1999 STMicroelectronics – Printed in Italy – All Rights Reserved

**STMicroelectronics GROUP OF COMPANIES**

Australia - Brazil - Canada - China - France - Germany - Italy - Japan - Korea - Malaysia - Malta - Mexico - Morocco  
 The Netherlands - Singapore - Spain - Sweden - Switzerland - Taiwan - Thailand - United Kingdom - U.S.A.

© <http://www.st.com>

