



HCF4021B

ASYNCHRONOUS PARALLEL IN OR SYNCHRONOUS SERIAL IN/SERIAL OUT 8 - STAGE STATIC SHIFT REGISTER

- MEDIUM SPEED OPERATION : 12 MHz (Typ.) CLOCK RATE AT $V_{DD} - V_{SS} = 10V$
- FULLY STATIC OPERATION
- 8 MASTER-SLAVE FLIP-FLOPS PLUS OUTPUT BUFFERING AND CONTROL GATING
- QUIESCENT CURRENT SPECIFIED UP TO 20V
- 5V, 10V AND 15V PARAMETRIC RATINGS
- INPUT LEAKAGE CURRENT
 $I_l = 100nA$ (MAX) AT $V_{DD} = 18V$ $T_A = 25^\circ C$
- 100% TESTED FOR QUIESCENT CURRENT
- MEETS ALL REQUIREMENTS OF JEDEC JESD13B " STANDARD SPECIFICATIONS FOR DESCRIPTION OF B SERIES CMOS DEVICES"



ORDER CODES

PACKAGE	TUBE	T & R
DIP	HCF4021BEY	
SOP	HCF4021BM1	HCF4021M013TR

DESCRIPTION

The HCF4021B is a monolithic integrated circuit fabricated in Metal Oxide Semiconductor technology available in DIP and SOP packages. This device is an 8-stage parallel or serial input/serial output register having common CLOCK and PARALLEL/SERIAL CONTROL inputs, a single SERIAL data input, and individual parallel "JAM" inputs to each register stage. Each register stage is a D-type, master-slave flip-flop in addition to an output from stage 8, "Q" outputs are also available from stages 6 and 7. Serial entry is synchronous with the clock but parallel entry is asynchronous.

In this device, entry is controlled by the PARALLEL/SERIAL CONTROL input. When the PARALLEL/SERIAL CONTROL input is low, data is serially shifted into the 8-stage register synchronously with the positive transition of the clock line. When the PARALLEL/SERIAL CONTROL input is high, data is jammed into the 8-stage register via the parallel input lines and synchronous with the positive transition of the clock line, the CLOCK input of the internal stage is "forced" when asynchronous parallel entry is made. Register expansion using multiple package is permitted.

PIN CONNECTION

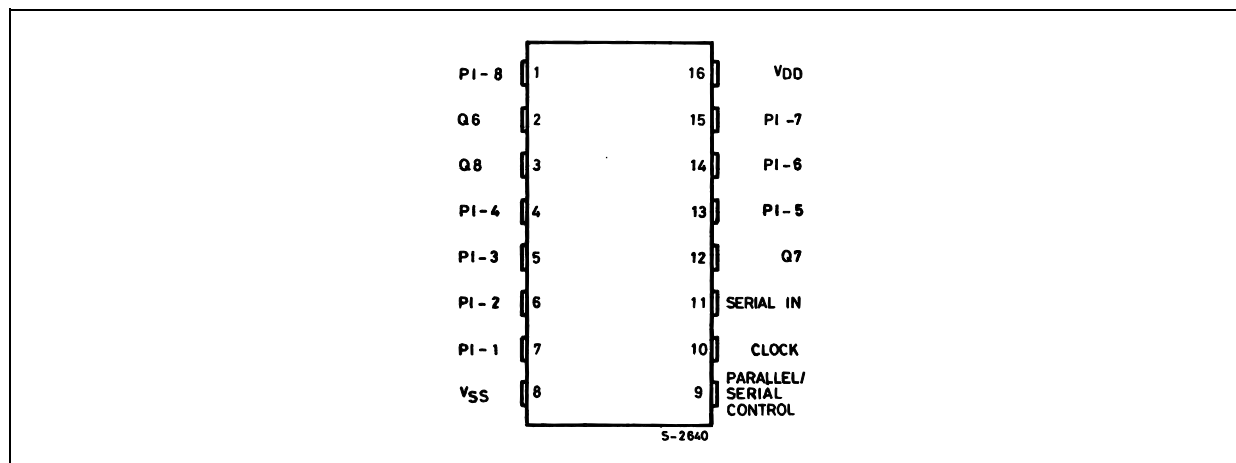

IINPUT EQUIVALENT CIRCUIT



PIN DESCRIPTION

PIN No	SYMBOL	NAME AND FUNCTION
7, 6, 5, 4, 13, 14, 15, 1	PI1 to PI8	Parallel Input
11	SERIAL IN	Serial Input
9	PARALLEL/SERIAL CONTROL	Parallel/Serial Input Control
10	CLOCK	Clock Input
2, 3, 12	Q6, Q7, Q8	Buffered Outputs
8	V _{SS}	Negative Supply Voltage
16	V _{DD}	Positive Supply Voltage

TRUTH TABLE

CLOCK	SERIAL INPUT	PARALLEL/SERIAL CONTROL	PI - 1	PI - n	Q ₁ (INTERNAL)	Q _n
X	X	1	0	0	0	0
X	X	1	0	1	0	1
X	X	1	1	0	1	0
X	X	1	1	1	1	1
	0	0	X	X	0	Q _n - 1
	1	0	X	X	1	Q _n - 1
	X	X	X	X	Q ₁	Q _n

X : Don't Care

LOGIC DIAGRAM

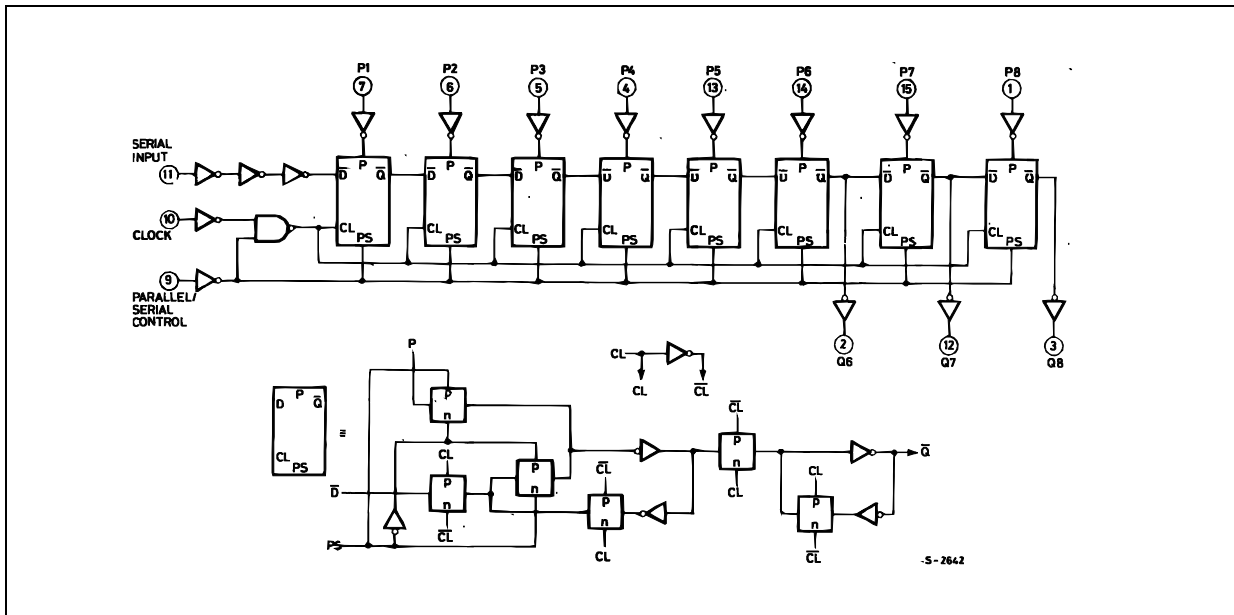

ABSOLUTE MAXIMUM RATINGS

Symbol	Parameter	Value	Unit
V_{DD}	Supply Voltage	-0.5 to +22	V
V_I	DC Input Voltage	-0.5 to $V_{DD} + 0.5$	V
I_I	DC Input Current	± 10	mA
P_D	Power Dissipation per Package	200	mW
	Power Dissipation per Output Transistor	100	mW
T_{op}	Operating Temperature	-55 to +125	°C
T_{stg}	Storage Temperature	-65 to +150	°C

Absolute Maximum Ratings are those values beyond which damage to the device may occur. Functional operation under these conditions is not implied.

All voltage values are referred to V_{SS} pin voltage.

RECOMMENDED OPERATING CONDITIONS

Symbol	Parameter	Value	Unit
V_{DD}	Supply Voltage	3 to 20	V
V_I	Input Voltage	0 to V_{DD}	V
T_{op}	Operating Temperature	-55 to 125	°C

DC SPECIFICATIONS

Symbol	Parameter	Test Condition				Value						Unit	
		V _I (V)	V _O (V)	I _{OL} (μ A)	V _{DD} (V)	T _A = 25°C			-40 to 85°C		-55 to 125°C		
						Min.	Typ.	Max.	Min.	Max.	Min.		Max.
I _L	Quiescent Current	0/5			5		0.04	5		150		150	μ A
		0/10			10		0.04	10		300		300	
		0/15			15		0.04	20		600		600	
		0/20			20		0.08	100		3000		3000	
V _{OH}	High Level Output Voltage	0/5		<1	5	4.95			4.95		4.95		V
		0/10		<1	10	9.95			9.95		9.95		
		0/15		<1	15	14.95			14.95		14.95		
V _{OL}	Low Level Output Voltage	5/0		<1	5		0.05			0.05		0.05	V
		10/0		<1	10		0.05			0.05		0.05	
		15/0		<1	15		0.05			0.05		0.05	
V _{IH}	High Level Input Voltage		0.5/4.5	<1	5	3.5			3.5		3.5		V
			1/9	<1	10	7			7		7		
			1.5/13.5	<1	15	11			11		11		
V _{IL}	Low Level Input Voltage		4.5/0.5	<1	5			1.5		1.5		1.5	V
			9/1	<1	10			3		3		3	
			13.5/1.5	<1	15			4		4		4	
I _{OH}	Output Drive Current	0/5	2.5	<1	5	-1.36	-3.2		-1.1		-1.1		mA
		0/5	4.6	<1	5	-0.44	-1		-0.36		-0.36		
		0/10	9.5	<1	10	-1.1	-2.6		-0.9		-0.9		
		0/15	13.5	<1	15	-3.0	-6.8		-2.4		-2.4		
I _{OL}	Output Sink Current	0/5	0.4	<1	5	0.44	1		0.36		0.36		mA
		0/10	0.5	<1	10	1.1	2.6		0.9		0.9		
		0/15	1.5	<1	15	3.0	6.8		2.4		2.4		
I _I	Input Leakage Current	0/18	Any Input		18		$\pm 10^{-5}$	± 0.1		± 1		± 1	μ A
C _I	Input Capacitance		Any Input				5	7.5					pF

The Noise Margin for both "1" and "0" level is: 1V min. with V_{DD}=5V, 2V min. with V_{DD}=10V, 2.5V min. with V_{DD}=15V

DYNAMIC ELECTRICAL CHARACTERISTICS ($T_{amb} = 25^{\circ}\text{C}$, $C_L = 50\text{pF}$, $R_L = 200\text{K}\Omega$, $t_r = t_f = 20\text{ ns}$)

Symbol	Parameter	Test Condition		Value (*)			Unit
		V_{DD} (V)		Min.	Typ.	Max.	
CLOCKED OPERATION							
t_{PLH} t_{PHL}	Propagation Delay Time	5			160	320	ns
		10			80	160	
		15			60	120	
t_{THL} t_{TLH}	Transition Time	5			100	200	ns
		10			50	100	
		15			40	80	
$f_{CL}^{(1)}$	Maximum Clock Input Frequency	5		3	6		MHz
		10		6	12		
		15		8.5	17		
t_W	Clock Pulse Width	5		180	90		ns
		10		80	40		
		15		50	25		
t_r , t_f	Clock Input Rise or Fall Time	5				15	μs
		10				15	
		15				15	
t_{setup}	Setup Time, serial Input (ref to CL)	5		120	60		ns
		10		80	40		
		15		60	30		
t_{setup}	Setup Time, Parallel Inputs (ref to P/S)	5		50	25		ns
		10		30	15		
		15		20	10		
t_{hold}	Hold Time, serial in, parallel in, parallel /serial control	5		0			ns
		10		0			
		15		0			
t_{WH}	P/S Pulse Widht	5		160	80		ns
		10		80	40		
		15		50	25		
t_{rem}	P/S Removal Time (ref to CL)	5		280	140		ns
		10		140	70		
		15		100	50		

(*) Typical temperature coefficient for all V_{DD} value is 0.3 %/°C.

(1) If more than one unit is cascaded t_{rCL} should be made less than or equal to the sum of the transition time and the fixed propagation delay of the output of the driving stage of the estimated capacitive load.

TEST CIRCUIT



$C_L = 50\text{pF}$ or equivalent (includes jig and probe capacitance)
 $R_L = 200\text{K}\Omega$
 $R_T = Z_{OUT}$ of pulse generator (typically 50Ω)

WAVEFORM 1 : PROPAGATION DELAY TIMES, CLOCK PULSE WIDTH ($f=1\text{MHz}$; 50% duty cycle)

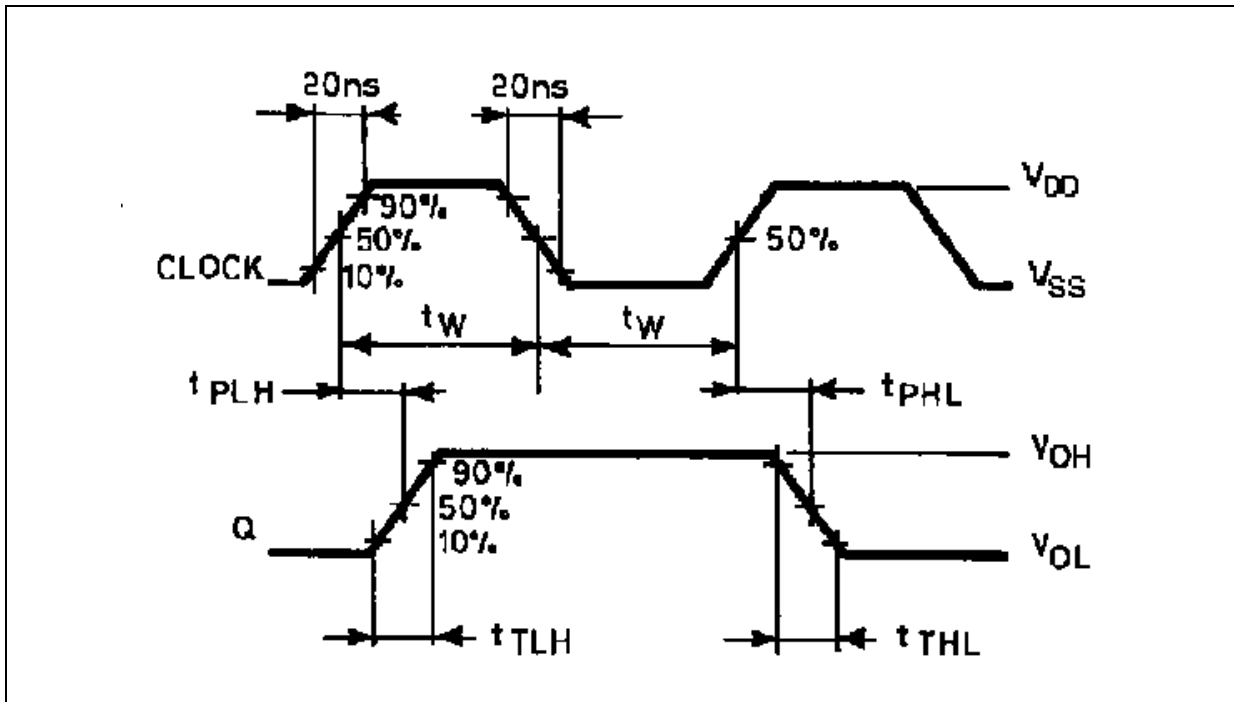

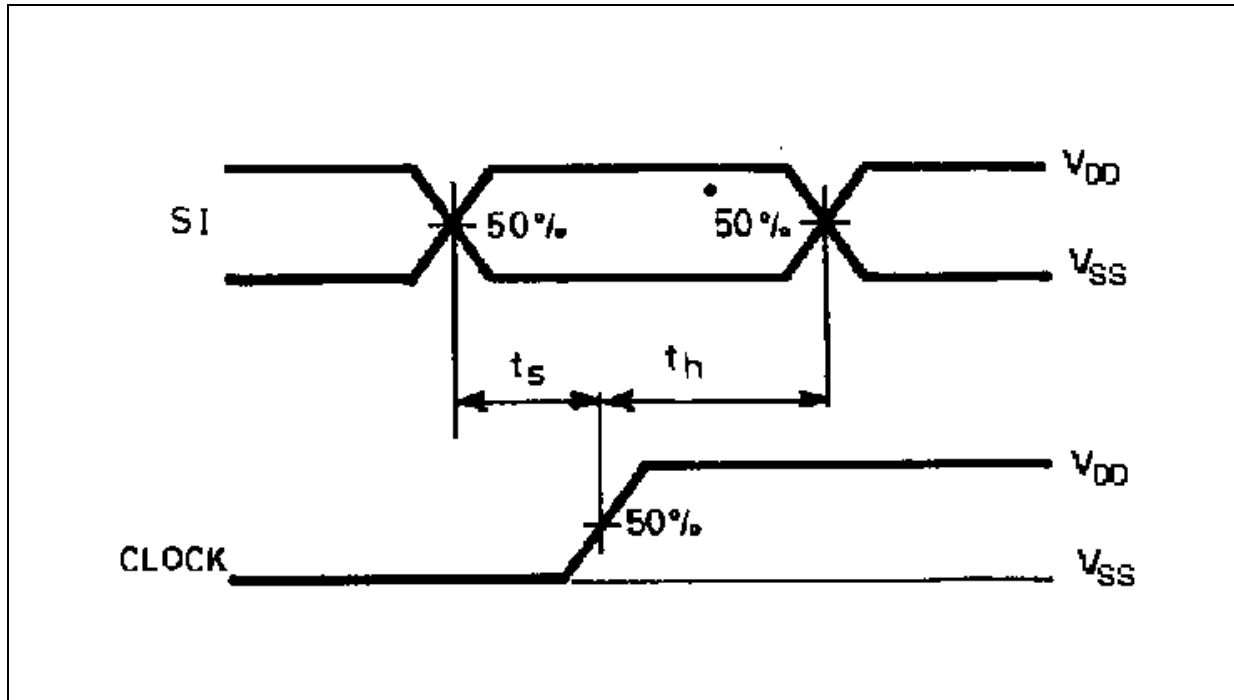
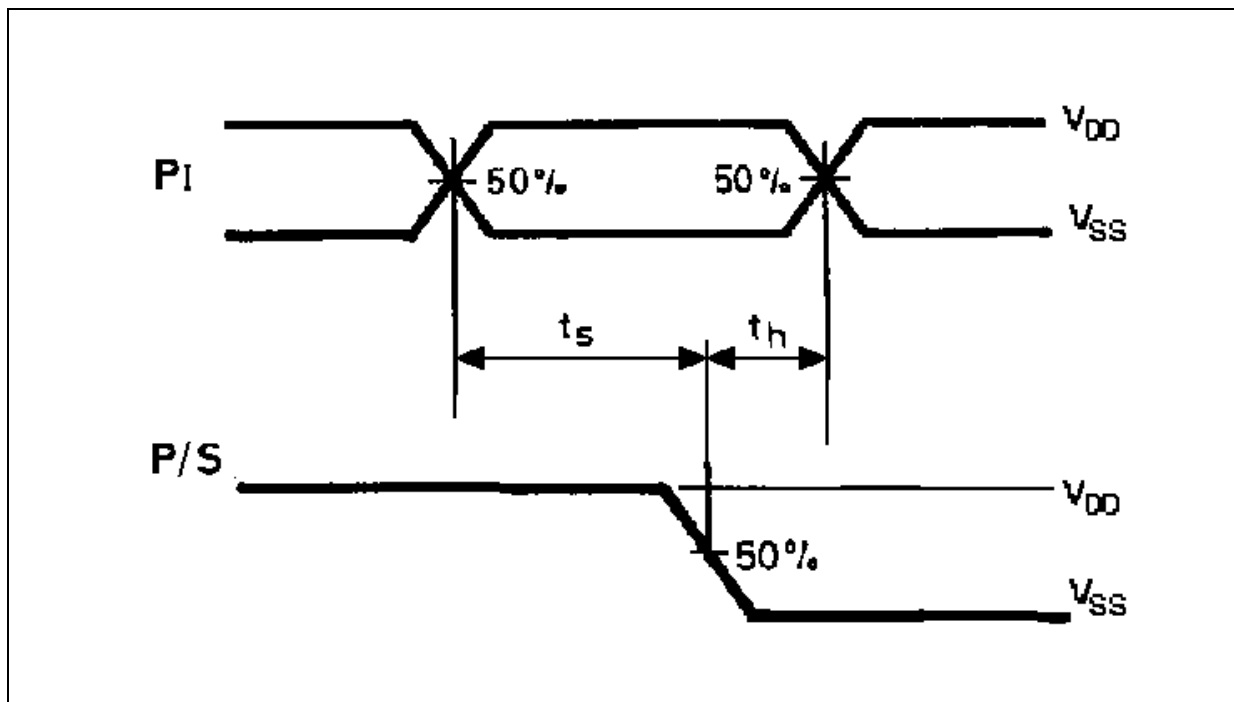
WAVEFORM 2 : SETUP AND HOLD TIMES (SI TO CLOCK) ($f=1\text{MHz}$; 50% duty cycle)WAVEFORM 3 : SETUP AND HOLD TIME (PI TO P/S) ($f=1\text{MHz}$; 50% duty cycle)

WAVEFORM 4 : PULSE WIDTH AND REMOVAL TIME (P/S TO CLOCK) (f=1MHz; 50% duty cycle)

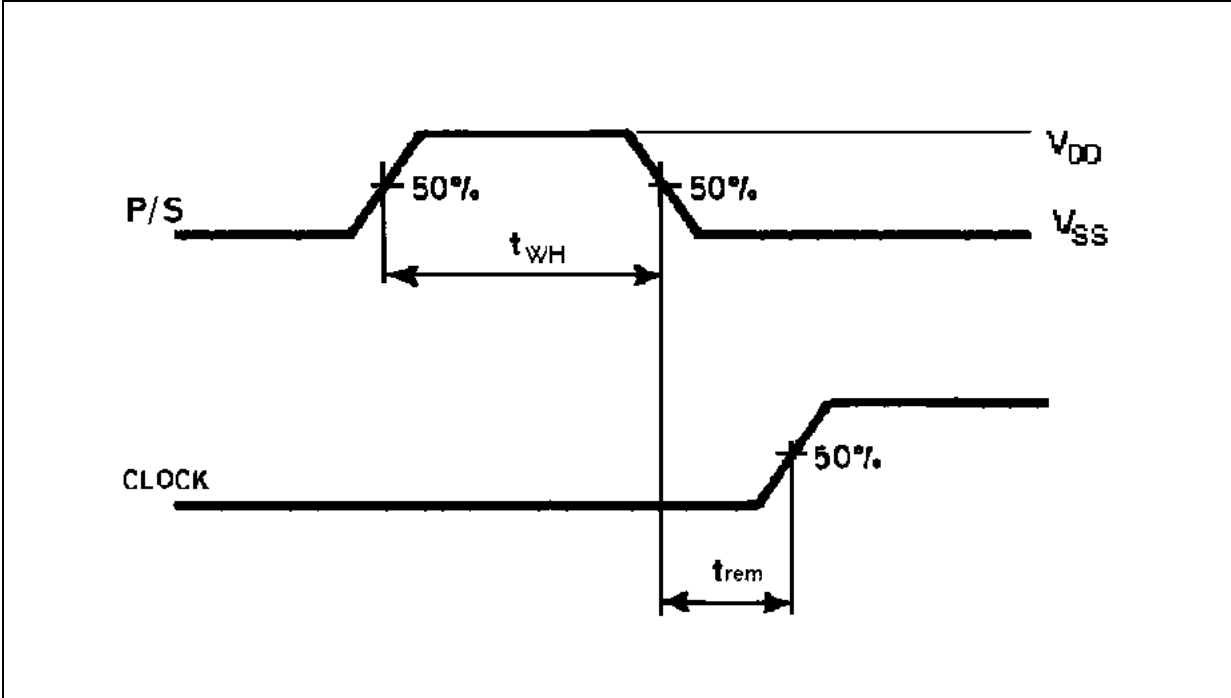

Plastic DIP-16 (0.25) MECHANICAL DATA

DIM.	mm.			inch		
	MIN.	TYP	MAX.	MIN.	TYP.	MAX.
a1	0.51			0.020		
B	0.77		1.65	0.030		0.065
b		0.5			0.020	
b1		0.25			0.010	
D			20			0.787
E		8.5			0.335	
e		2.54			0.100	
e3		17.78			0.700	
F			7.1			0.280
I			5.1			0.201
L		3.3			0.130	
Z			1.27			0.050

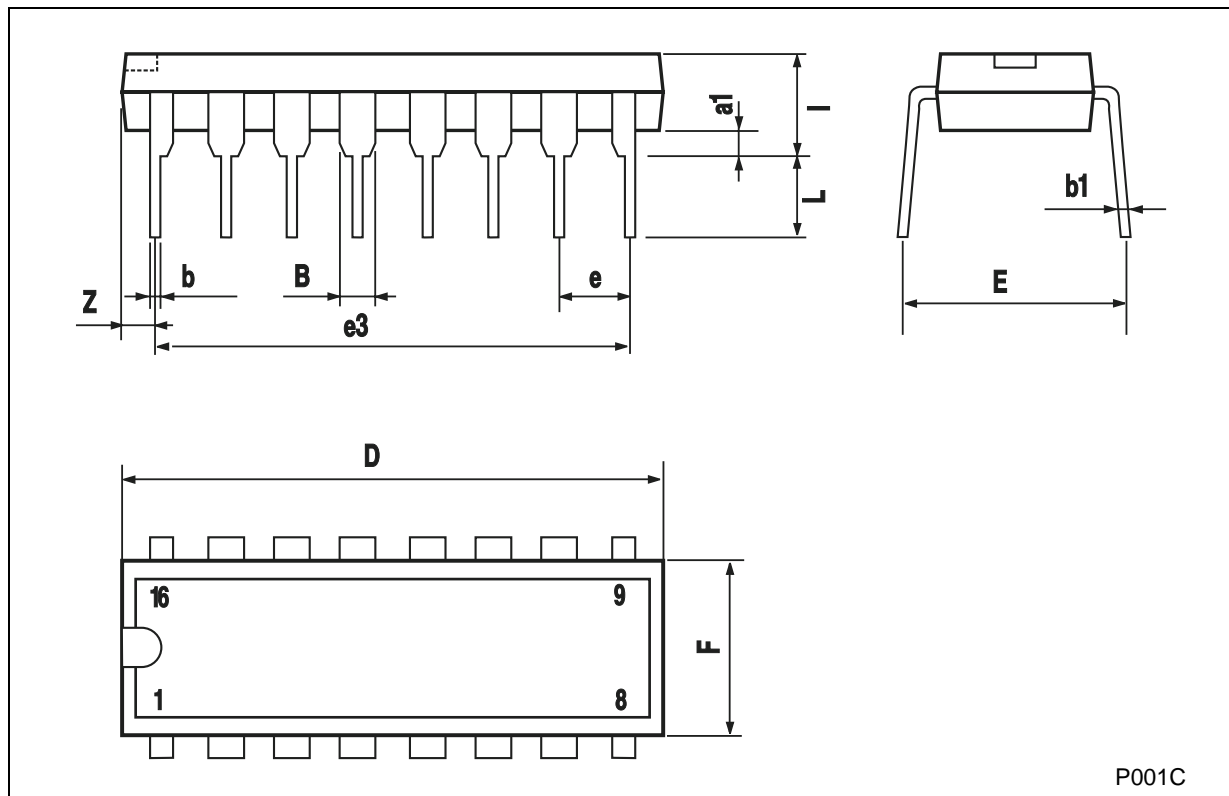

SO-16 MECHANICAL DATA

DIM.	mm.			inch		
	MIN.	TYP.	MAX.	MIN.	TYP.	MAX.
A			1.75			0.068
a1	0.1		0.2	0.003		0.007
a2			1.65			0.064
b	0.35		0.46	0.013		0.018
b1	0.19		0.25	0.007		0.010
C		0.5			0.019	
c1	45° (typ.)					
D	9.8		10	0.385		0.393
E	5.8		6.2	0.228		0.244
e		1.27			0.050	
e3		8.89			0.350	
F	3.8		4.0	0.149		0.157
G	4.6		5.3	0.181		0.208
L	0.5		1.27	0.019		0.050
M			0.62			0.024
S	8° (max.)					



PO13H

Information furnished is believed to be accurate and reliable. However, STMicroelectronics assumes no responsibility for the consequences of use of such information nor for any infringement of patents or other rights of third parties which may result from its use. No license is granted by implication or otherwise under any patent or patent rights of STMicroelectronics. Specifications mentioned in this publication are subject to change without notice. This publication supersedes and replaces all information previously supplied. STMicroelectronics products are not authorized for use as critical components in life support devices or systems without express written approval of STMicroelectronics.

© The ST logo is a registered trademark of STMicroelectronics

© 2001 STMicroelectronics - Printed in Italy - All Rights Reserved
STMicroelectronics GROUP OF COMPANIES

Australia - Brazil - China - Finland - France - Germany - Hong Kong - India - Italy - Japan - Malaysia - Malta - Morocco
Singapore - Spain - Sweden - Switzerland - United Kingdom

© <http://www.st.com>

