

Four-Way 0° Power Splitter Combiner 0.81–0.96 GHz



PD4W09-12

Features

- Low Cost
- Low Profile
- Available in Small SOIC-8 Package
- Tape & Reel

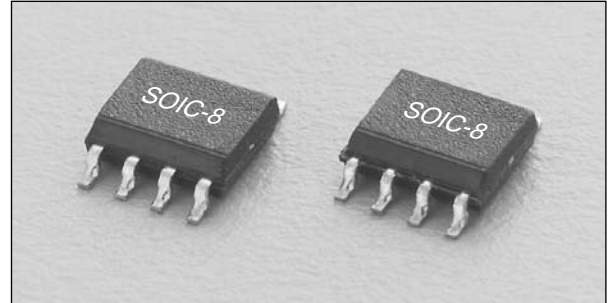

Description

The PD4W09-12 is a monolithic four-way in-phase hybrid junction tuned for the 0.81–0.96 GHz band. It offers low loss, high isolation, good input/output matching and exceptional phase/amplitude balance. It is available in the SOIC-8 leaded surface mount package.

Electrical Specifications at 25°C

Parameter	Min.	Typ.	Max.	Unit
Frequency	0.81		0.96	GHz
Insertion Loss Less 6 dB Split		1.3	1.5	dB
Isolation	20	23		dB
Input VSWR		1.2:1	1.5:1	
Output VSWR		1.2:1	1.5:1	
Amplitude Balance		±0.4	±0.6	dB
Phase Balance		±6	±8	Deg.

Pin Out

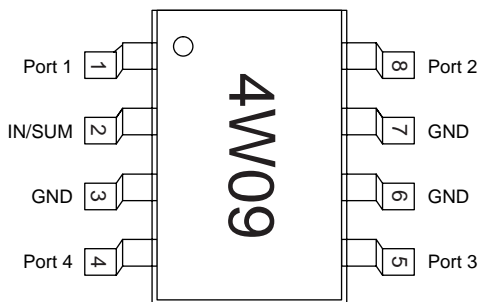

Block Diagram

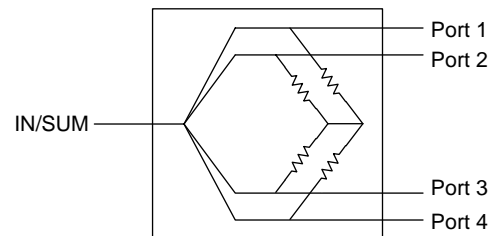

Performance Data

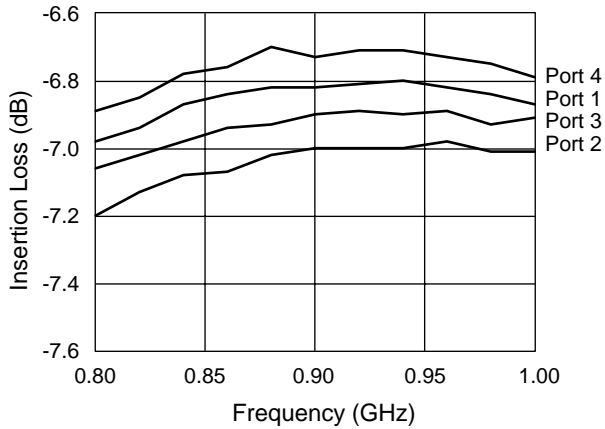

Insertion Loss vs. Frequency

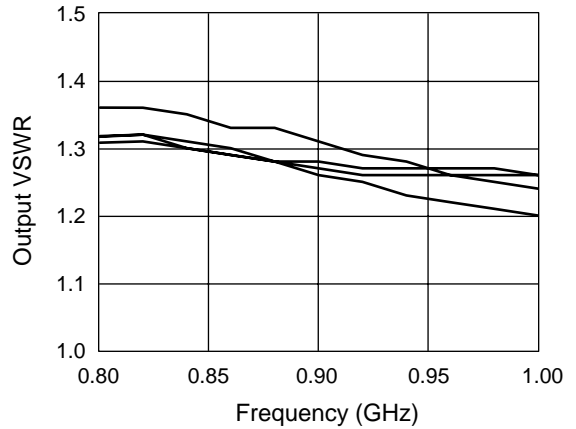

Output VSWR vs. Frequency

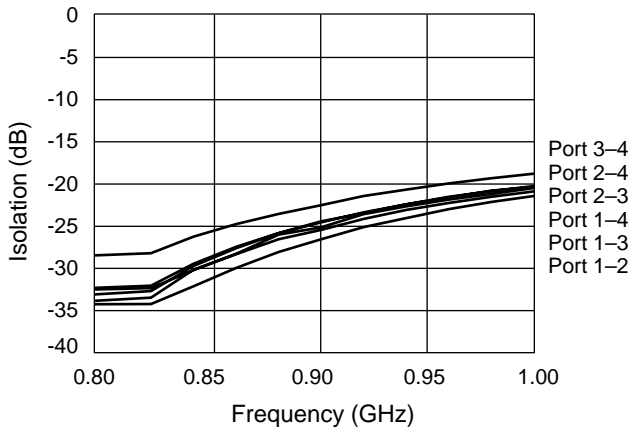

Isolation vs. Frequency

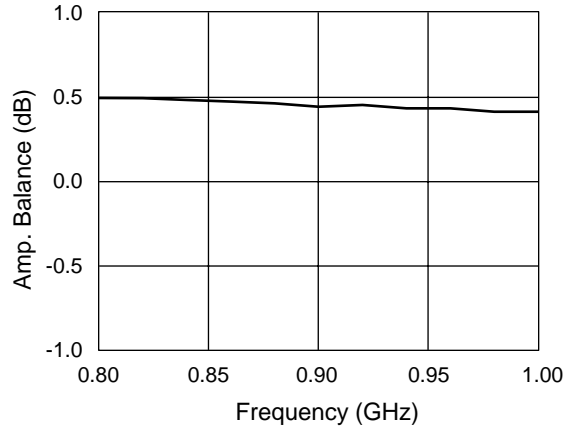

Amp. Balance vs. Frequency

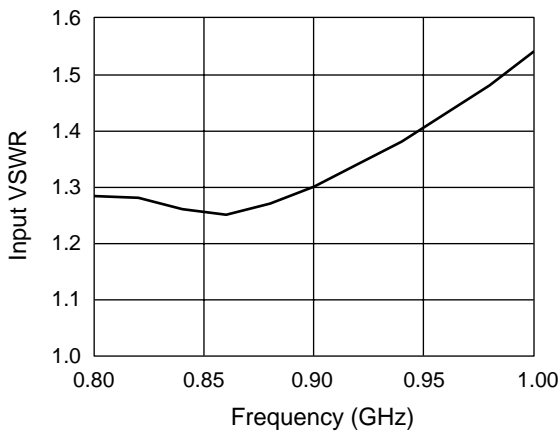

Input VSWR vs. Frequency

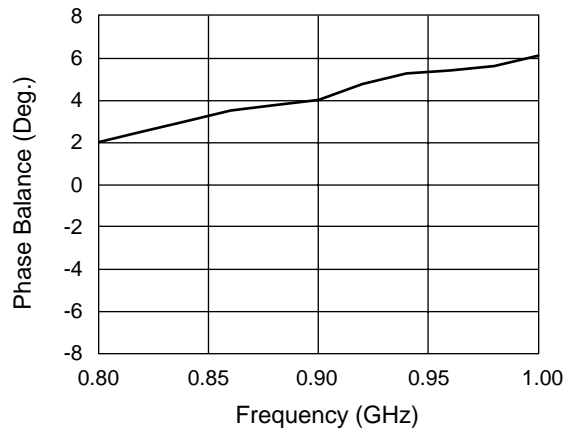

Phase Balance vs. Frequency

Absolute Maximum Ratings

Characteristic	Value
Input Power ¹	+1.5 W CW
Input Power ²	+0.375 CW
Operating Temperature	-40°C to +85°C
Storage Temperature	-65°C to +150°C

1. When used as a power divider with a 2.0:1 maximum VSWR on all ports.
2. When used as a power combiner with a 2.0:1 maximum VSWR on all ports.

Recommended Board Layout

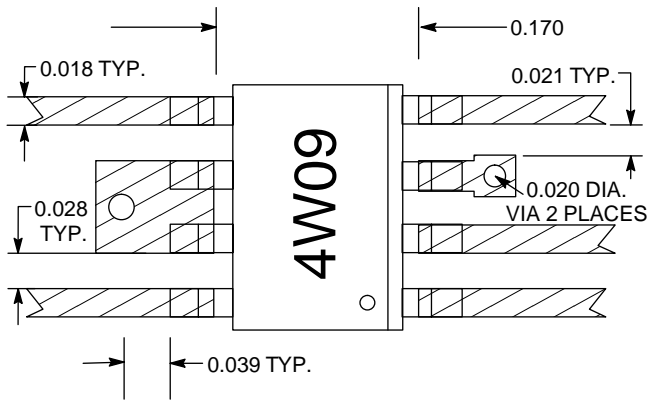

Material is 10 mil FR4

SOIC-8

