

PC512

European Safety Standard Approved Long Creepage Distance Type Photocoupler

■ Features

1. Conform to European Safety Standards

UL file No. E64380

Approved by VDE (DIN VDE0884 : No. 77296)

Approved by BSI

(BS EN60065 IEC65 Test Leaflets land 5

BS EN60950 IEC950 EN41003 Test Leaflets land 5)

Approved by SEMKO (No. 9303001)

Approved by DEMKO (108025)

Approved by EI (155031-01)

Approved by CSA (CA95323 or CA76261)

2. Long creepage distance type

(Creepage distance : 11.5mm or more)

3. Compact

4. High isolation voltage (V_{iso} : 5 000V_{rms})

■ Applications

1. Power supplies

■ Outline Dimensions

(Unit : mm)

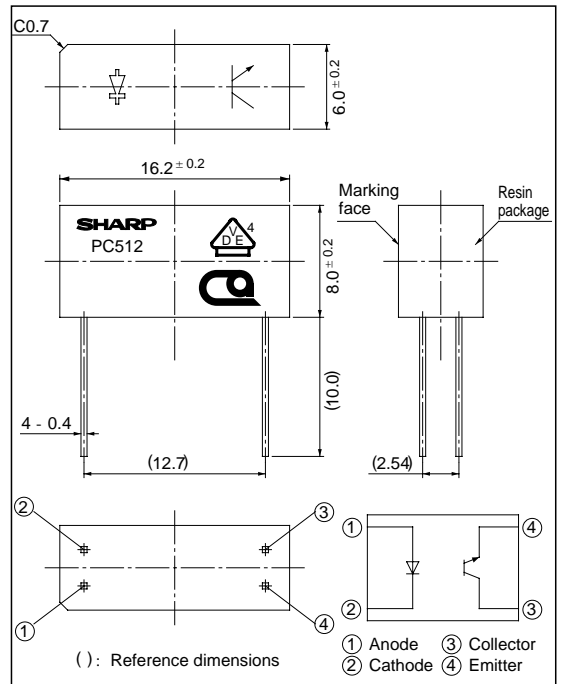

■ Absolute Maximum Ratings

($T_a = 25^\circ\text{C}$)

Parameter		Symbol	Rating	Unit
Input	Forward current	I_F	50	mA
	*1 Peak forward current	I_{FM}	1	A
	Reverse voltage	V_R	6	V
	Power dissipation	P	75	mW
Output	Collector-emitter voltage	V_{CEO}	35	V
	Emitter-collector voltage	V_{ECO}	6	V
	Collector current	I_C	20	mA
	Collector power dissipation	P_C	75	mW
*2 Isolation voltage		V_{iso}	5	kV _{rms}
Operating temperature		T_{opr}	- 25 to + 85	$^\circ\text{C}$
Storage temperature		T_{stg}	- 40 to + 100	$^\circ\text{C}$
*3 Soldering temperature		T_{sol}	260	$^\circ\text{C}$

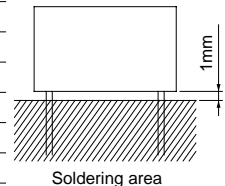

*1 Pulse width $\leq 100\mu\text{s}$ Duty ratio : 0.001

*2 AC for 1 minute, 40 to 60% RH

*3 For MAX. 10 seconds at the position of 1mm from the edge of resin package.

Electro-optical Characteristics

(T_a = 25°C)

Parameter		Symbol	Conditions	MIN.	TYP.	MAX.	Unit
Input	Forward voltage	V _F	I _F = 20mA	-	1.2	1.4	V
	Peak forward voltage	V _{FM}	I _{FM} = 0.5A	-	3	4	V
	Reverse current	I _R	V _R = 3V	-	-	10	μA
	Terminal capacitance	C _t	V = 0, f = 1kHz	-	50	250	pF
Output	Collector dark current	I _{CEO}	V _{CE} = 20V, I _F = 0	-	-	100	nA
	Collector-emitter breakdown voltage	BV _{CEO}	I _C = 0.1mA, I _F = 0	35	-	-	V
	Emitter-collector breakdown voltage	BV _{ECO}	I _E = 10μA, I _F = 0	6	-	-	V
Transfer characteristics	Collector current	I _C	I _F = 20mA, V _{CE} = 5V	2	-	20	mA
	Collector-emitter saturation voltage	V _{CE(sat)}	I _F = 40mA, I _C = 1mA	-	-	0.4	V
	Isolation resistance	R _{iso}	DC500V, 40 to 60% RH	10 ¹²	-	-	Ω
	Cut-off frequency	f _c	V _{CE} = 2V, I _C = 2mA R _L = 100Ω, -3dB	12	80	-	kHz
				Response time	Rise time	t _r	V _{CE} = 2V, I _C = 2mA R _L = 100Ω
Fall time	t _f	-	4		30	μs	

Fig. 1 Forward Current vs. Ambient Temperature

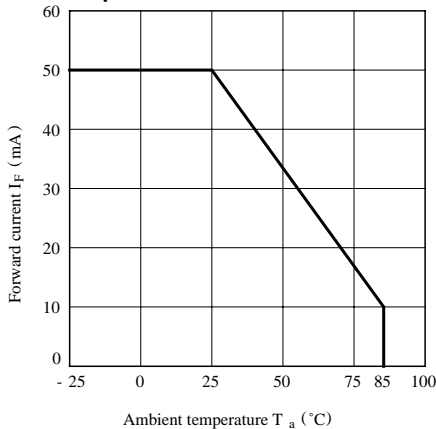

Fig. 2 Collector Power Dissipation vs. Ambient Temperature

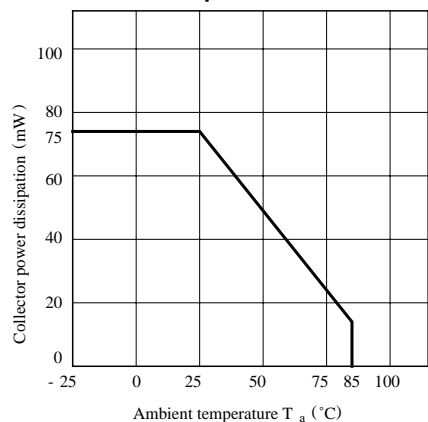

Fig. 3 Peak Forward Current vs. Duty Ratio

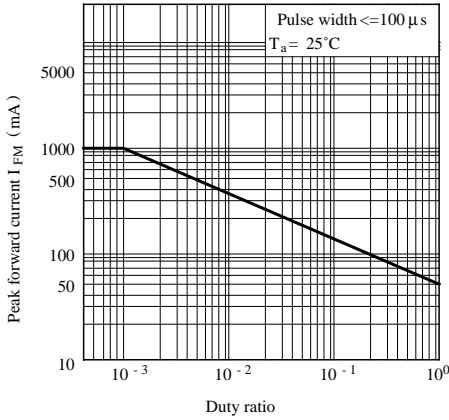

Fig. 4 Forward Current vs. Forward Voltage

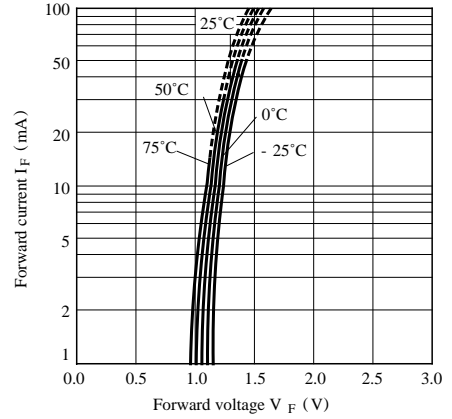

Fig. 5 Current Transfer Ratio vs. Forward Current

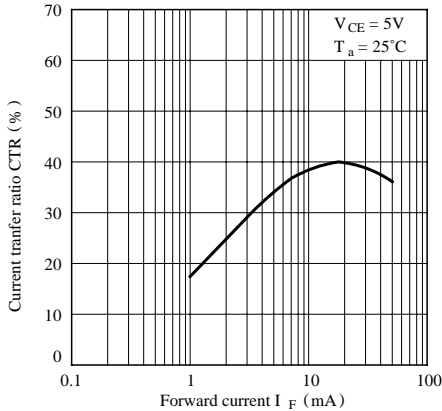

Fig. 6 Collector Current vs. Collector-emitter Voltage

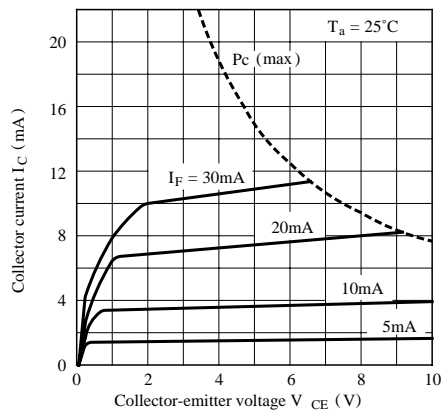

Fig. 7 Relative Current Transfer Ratio vs. Ambient Temperature

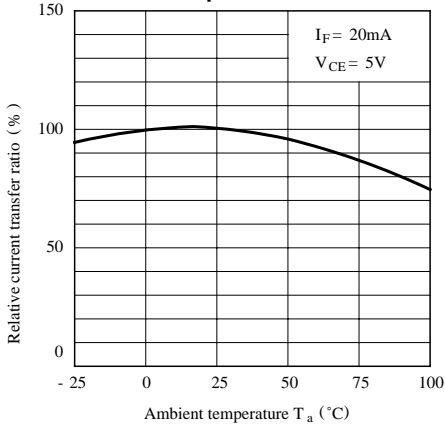

Fig. 8 Collector-emitter Saturation Voltage vs. Ambient Temperature

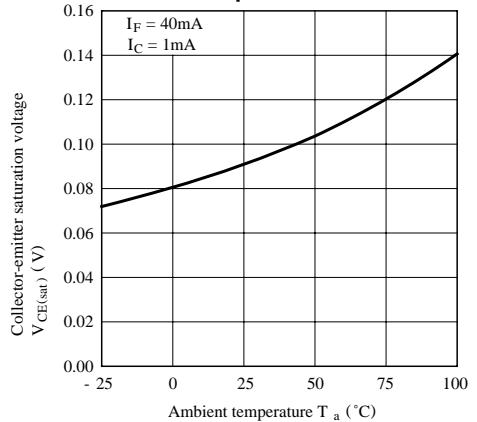

Fig. 9 Collector Dark Current vs. Ambient Temperature

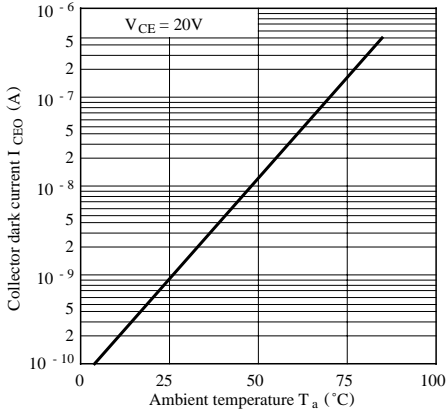

Fig.10 Response Time vs. Load Resistance

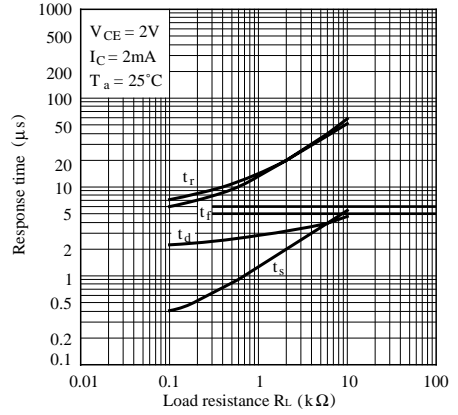

Fig.11 Frequency Response

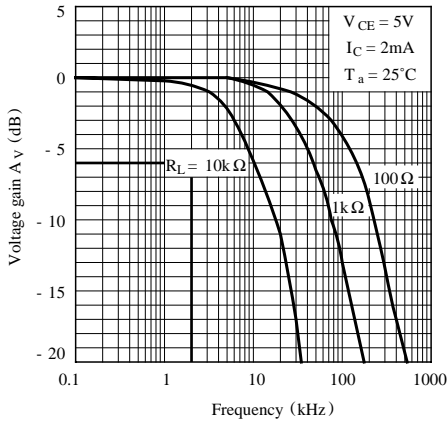
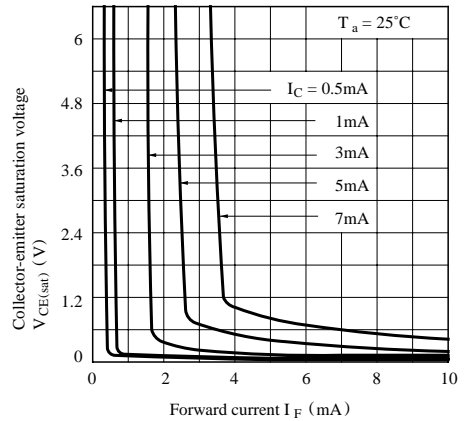

Fig.12 Collector-emitter Saturation Voltage vs. Forward Current



● Please refer to the chapter “Precautions for Use”