

Description:

The Powerex POW-R-PAK™ is a configurable IGBT based power assembly that may be used as a converter, chopper, half or full bridge, or three phase inverter for motor control, power supply, UPS or other power conversion applications.

The power assembly is mounted on a forced air-cooled heatsink and features state-of-the-art Powerex F-series trench gate IGBTs with low conduction and switching losses for high efficiency operation. The POW-R-PAK™ includes a low inductance laminated bus structure, optically isolated gate drive interfaces, isolated gate drive power supplies, and a DC-link capacitor bank. The control board provides a simple user interface along with built-in protection features including overvoltage, undervoltage lockout, overcurrent, overtemperature, and short circuit detection.

Depending on application characteristics the POW-R-PAK™ is suitable for operation with DC bus voltages up to 400VDC and switching frequencies above 20kHz.

Schematic**Features:**

- High performance IGBT inverter bridge
- Integrated gate drive with fault monitoring & protection
- System status / troubleshooting LEDs to verify or monitor proper operation
- Isolated gate drive power supplies
- Low inductance laminated bus
- Output current measurement & feedback
- Superior short circuit detection & shoot through prevention

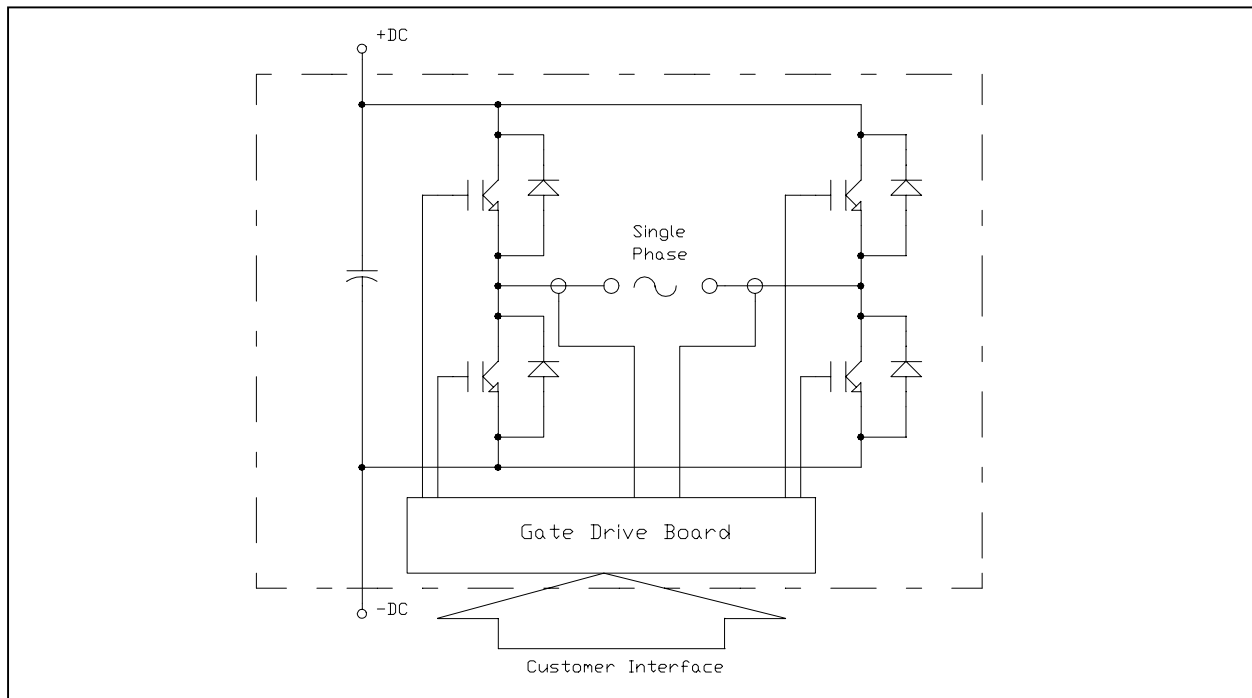

Absolute Maximum Ratings, $T_j = 25^\circ\text{C}$ unless otherwise specified

General	Symbol		Units
IGBT Junction Temperature	T_j	-40 to +150	$^\circ\text{C}$
Storage Temperature	T_{stg}	-40 to +125	$^\circ\text{C}$
Operating Temperature	T_{op}	-25 to +85	$^\circ\text{C}$
Voltage Applied to DC terminals	V_{CC}	400	Volts
Isolation Voltage, AC 1 minute, 60Hz sinusoidal	V_{iso}	2500	Volts
IGBT Inverter			
Collector Current ($T_c = 25^\circ\text{C}$)	I_c	100	Amperes
Peak Collector Current ($T_j < 150^\circ\text{C}$)	I_{CM}	200	Amperes
Emitter Current	I_E	100	Amperes
Peak Emitter Current	I_{EM}	200	Amperes
Maximum Collector Dissipation ($T_j < 150^\circ\text{C}$)	P_c	350	Watts
Gate Drive Board			
Unregulated +24V Power Supply		30	Volts
Regulated +15V Power Supply		18	Volts
PWM Signal Input Voltage		20	Volts
Fault Output Supply Voltage		30	Volts
Fault Output Current		50	mA

IGBT Inverter Electrical Characteristics, $T_j = 25^\circ\text{C}$ unless otherwise specified

Characteristics	Symbol	Test Conditions	Min	Typ	Max	Units
Collector Cutoff Current	I_{CES}	$V_{\text{CE}} = V_{\text{CES}}, V_{\text{GE}} = 0\text{V}$	-	-	1	mA
Collector – Emitter Saturation Voltage	$V_{\text{CE(sat)}}$	$I_c = 100\text{A}, T_j = 25^\circ\text{C}$	-	1.6	2.2	Volts
		$I_c = 100\text{A}, T_j = 125^\circ\text{C}$	-	1.6	-	Volts
Emitter – Collector Voltage	V_{EC}	$I_E = 100\text{A}$	-	-	2.6	Volts
Inductive Load Switching Times	$t_{\text{d(on)}}$	$V_{\text{CC}} = 300\text{V}$ $I_c = 100\text{A}$ $V_{\text{GE}} = 15\text{V}$ $R_G = 6.3\Omega$	-	-	100	ns
	t_r		-	-	80	ns
	$t_{\text{d(off)}}$		-	-	300	ns
	t_f		-	-	250	ns
Diode Reverse Recovery Time	t_{rr}		-	-	150	ns
Diode Reverse Recovery Charge	Q_{rr}		-	1.9	-	μC
DC Link Capacitance				18000		μF

Gate Drive Board Electrical Characteristics

Characteristics	Min	Typ	Max	Units
Unregulated +24V Power Supply	20	24	30	Volts
Regulated +15V Power Supply	14.4	15	18	Volts
PWM Input On Threshold	12	15		Volts
PWM Input Off Threshold		0	2	Volts
Output Overcurrent Trip		150		Amperes
Overtemperature Trip	96	98	100	°C
Overvoltage Trip		460		Volts
DC Link Voltage Feedback	See Figure Below			Volts
Heatsink Temperature Feedback	See Figure Below			Volts
Output Current Feedback	See Figure Below			Volts

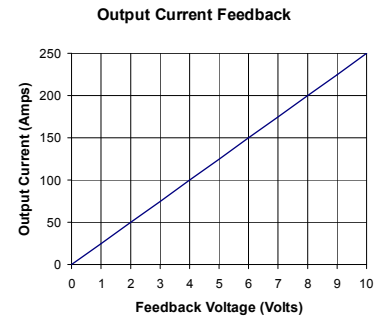

Thermal and Mechanical Characteristics

Characteristics	Symbol	Test Conditions	Min	Typ	Max	Units
IGBT Thermal Resistance, Junction to Case	$R_{th(j-c)Q}$	Per IGBT ½ module	-	0.23	0.35	°C/W
FWD Thermal Resistance, Junction to Case	$R_{th(j-c)D}$	Per FWD ½ module			0.70	°C/W
Contact Thermal Resistance	$R_{th(c-f)}$		-	0.055	-	°C/W
Heatsink Thermal Resistance	$R_{th(f-a)}$	1500 LFM airflow		0.040		°C/W
Mounting Torque, AC terminals				75	90	in-lb
Mounting Torque, DC terminals				130	150	in-lb
Mounting Torque, Mounting plate				130	150	in-lb
Weight				21		lb

Gate Drive Board Interface Signal Definitions

Pin	Signal Name	Description
1	Shield	Connected to circuit ground
2	PWM A-	0-15 V signal controlling the duty cycle of A- IGBT
3	Phase A Error ¹	Open collector output, external pull-up resistor required LOW = No Error; Floating = Phase A overcurrent or short circuit
4	PWM A+	0-15 V signal controlling the duty cycle of A+ IGBT
5	PWM B-	0-15 V signal controlling the duty cycle of B- IGBT
6	Phase B Error ¹	Open collector output, external pull-up resistor required LOW = No Error; Floating = Phase B overcurrent or short circuit
7	PWM B+	0-15 V signal controlling the duty cycle of B+ IGBT
8	Not Used	
9	Not Used	
10	Not Used	
11	Overtemp ¹	Open collector output, external pull-up resistor required LOW = No Error; Floating = heatsink overtemp
12	Not Connected	
13	DC Link Voltage	Analog voltage representation of DC link voltage
14	24 VDC input power ²	20 – 30 VDC input voltage range
15	24 VDC input power ²	20 – 30 VDC input voltage range
16	15 VDC input power ²	14.4 – 18 VDC input voltage range
17	15 VDC input power ²	14.4 – 18 VDC input voltage range
18	GND	Ground reference for 15 and 24 VDC inputs
19	GND	Ground reference for 15 and 24 VDC inputs
20	Heatsink Temperature	Analog voltage representation of heatsink temperature
21	GND ³	Tied to pins 18 and 19
22	I _{out} Phase A	Analog voltage representation of phase A output current
23	GND ³	Tied to pins 18 and 19
24	I _{out} Phase B	Analog voltage representation of phase B output current
25	Not Used	
26	Not Used	

Notes:

1. Open collectors can be pulled up to 30 V max and sink 50mA continuous.
2. Do not connect a 15 VDC and 24 VDC source to the unit at the same time, use one or the other.
3. GND signals to be used for analog feedback signals, i.e. twisted pair with I_{out} Phase A.

Gate Drive Board Interface Connector

Description	Symbol	Type	Manufacturer
Gate Drive Board Interface Header	J1	0.100" x 0.100" latching header, 26 pin	3M# 3429-6002 or equivalent
Recommended Mating Socket	-	0.100" x 0.100" IDC socket, 26 pin	3M# 3399-7600 or equivalent
Recommended Strain Relief	-	Plastic strain relief	3M# 3448-3026 or equivalent

Performance Curves

Effective Output Current vs. Carrier Frequency (Typical)

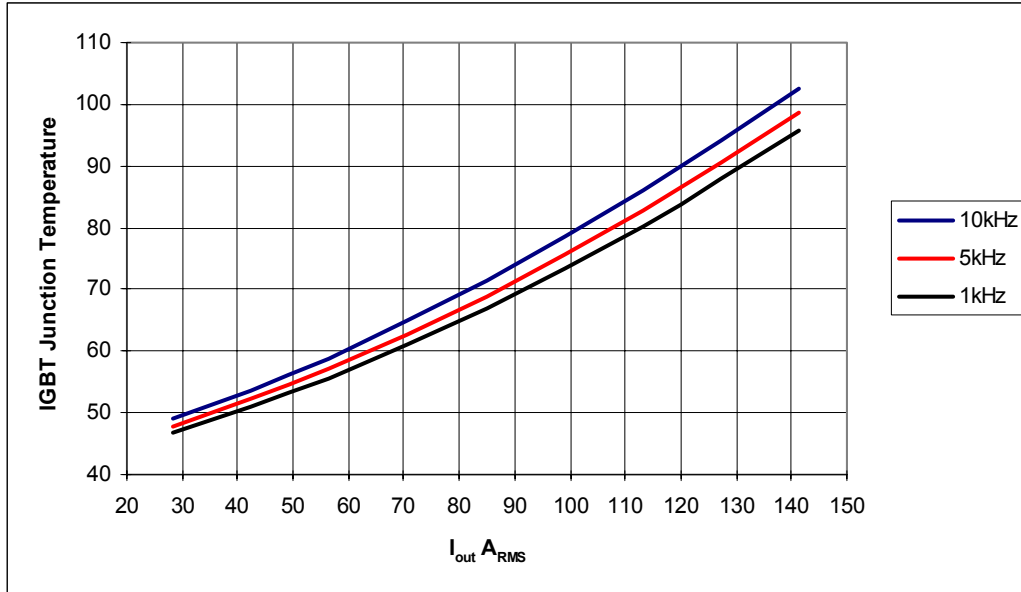

Condition	Symbol	Value	Units
Ambient Temperature	T_A	40	°C
DC Bus Voltage	V_{CC}	300	Volts
Load Power Factor	$\cos \phi$	0.8	
IGBT Saturation Voltage	$V_{CE(sat)}$	Typical @ $T_J = 125^\circ\text{C}$	Volts
IGBT Switching Loss	E_{SW}	Typical @ $T_J = 125^\circ\text{C}$	mJ
Airflow	-	1500	LFM
Switching Conditions	3 phase PWM, 60Hz sinusoidal output		

Mechanical Drawing