

**ANSALDO****Ansaldo Trasporti s.p.a.**  
**Unita' Semiconduttori**Via N. Lorenzi 8 - I 16152 GENOVA - ITALY  
Tel. int. +39/(0)10 6556549 - (0)10 6556488  
Fax Int. +39/(0)10 6442510  
Tx 270318 ANSUSE I -**FAST SWITCHING THYRISTOR****ATF585**

|                          |              |
|--------------------------|--------------|
| Repetitive voltage up to | <b>800 V</b> |
| Mean on-state current    | <b>445 A</b> |
| Surge current            | <b>6 kA</b>  |
| Turn-off time            | <b>15 µs</b> |

**FINAL SPECIFICATION**

feb 97 - ISSUE : 03

| Symbol  | Characteristic                                  | Conditions  | T <sub>j</sub><br>[°C] | Value     | Unit             |         |  |         |         |         |         |         |  |  |         |         |         |         |         |  |  |         |         |         |         |         |
|---|---|---|------------------------|-----------|------------------|---------|--|---------|---------|---------|---------|---------|--|--|---------|---------|---------|---------|---------|--|--|---------|---------|---------|---------|---------|
| <b>BLOCKING</b>   |   |   |                        |           |                  |         |  |         |         |         |         |         |  |  |         |         |         |         |         |  |  |         |         |         |         |         |
| V <sub>RRM</sub>  | Repetitive peak reverse voltage                 |   | 125                    | 800       | V                |         |  |         |         |         |         |         |  |  |         |         |         |         |         |  |  |         |         |         |         |         |
| V <sub>RSM</sub>  | Non-repetitive peak reverse voltage             |   | 125                    | 900       | V                |         |  |         |         |         |         |         |  |  |         |         |         |         |         |  |  |         |         |         |         |         |
| V <sub>DRM</sub>  | Repetitive peak off-state voltage               |   | 125                    | 800       | V                |         |  |         |         |         |         |         |  |  |         |         |         |         |         |  |  |         |         |         |         |         |
| I <sub>RRM</sub>  | Repetitive peak reverse current                 | V=VRRM  | 125                    | 40        | mA               |         |  |         |         |         |         |         |  |  |         |         |         |         |         |  |  |         |         |         |         |         |
| I <sub>DRM</sub>  | Repetitive peak off-state current               | V=VDRM  | 125                    | 40        | mA               |         |  |         |         |         |         |         |  |  |         |         |         |         |         |  |  |         |         |         |         |         |
| <b>CONDUCTING</b>   |   |   |                        |           |                  |         |  |         |         |         |         |         |  |  |         |         |         |         |         |  |  |         |         |         |         |         |
| I <sub>T(AV)</sub>  | Mean on-state current                           | 180° sin, 50 Hz, Th=55°C, double side cooled                    |                        | 445       | A                |         |  |         |         |         |         |         |  |  |         |         |         |         |         |  |  |         |         |         |         |         |
| I <sub>T(AV)</sub>  | Mean on-state current                           | 180° sin, 1 kHz, Th=55°C, double side cooled                    |                        | 400       | A                |         |  |         |         |         |         |         |  |  |         |         |         |         |         |  |  |         |         |         |         |         |
| I <sub>TSM</sub>  | Surge on-state current, non repetitive          | sine wave, 10 ms  | 125                    | 6         | kA               |         |  |         |         |         |         |         |  |  |         |         |         |         |         |  |  |         |         |         |         |         |
| I <sup>2</sup> t  | I <sup>2</sup> t                                | without reverse voltage   |                        | 180 x1E3  | A <sup>2</sup> s |         |  |         |         |         |         |         |  |  |         |         |         |         |         |  |  |         |         |         |         |         |
| V <sub>T</sub>  | On-state voltage                                | On-state current = 800 A  | 25                     | 1.7       | V                |         |  |         |         |         |         |         |  |  |         |         |         |         |         |  |  |         |         |         |         |         |
| V <sub>T(TO)</sub>  | Threshold voltage                               |   | 125                    | 1.30      | V                |         |  |         |         |         |         |         |  |  |         |         |         |         |         |  |  |         |         |         |         |         |
| r <sub>T</sub>  | On-state slope resistance                       |   | 125                    | 0.325     | mohm             |         |  |         |         |         |         |         |  |  |         |         |         |         |         |  |  |         |         |         |         |         |
| <b>SWITCHING</b>  |   |   |                        |           |                  |         |  |         |         |         |         |         |  |  |         |         |         |         |         |  |  |         |         |         |         |         |
| di/dt   | Critical rate of rise of on-state current, min  | From 75% VDRM up to 1200 A, gate 20V 10 ohm                     | 125                    | 200       | A/µs             |         |  |         |         |         |         |         |  |  |         |         |         |         |         |  |  |         |         |         |         |         |
| dv/dt   | Critical rate of rise of off-state voltage, min | Linear ramp up to 70% of VDRM                                   | 125                    | 500       | V/µs             |         |  |         |         |         |         |         |  |  |         |         |         |         |         |  |  |         |         |         |         |         |
| td  | Gate controlled delay time, typical             | VD=100V, gate source 20V, 10 ohm , tr=1 µs                      | 25                     | 0.6       | µs               |         |  |         |         |         |         |         |  |  |         |         |         |         |         |  |  |         |         |         |         |         |
| tq  | Circuit commutated turn-off time                | di/dt = 20 A/µs, I = 250 A<br>dV/dt = 200 V/µs , up to 75% VDRM | 125                    | 15        | µs               |         |  |         |         |         |         |         |  |  |         |         |         |         |         |  |  |         |         |         |         |         |
| Q <sub>rr</sub>   | Reverse recovery charge                         | di/dt = 60 A/µs, I = 1000 A                                     | 125                    | 140       | µC               |         |  |         |         |         |         |         |  |  |         |         |         |         |         |  |  |         |         |         |         |         |
| I <sub>rr</sub>   | Peak reverse recovery current                   | VR = 50 V   |                        | 104       | A                |         |  |         |         |         |         |         |  |  |         |         |         |         |         |  |  |         |         |         |         |         |
| I <sub>H</sub>  | Holding current, typical                        | VD=5V, gate open circuit  | 25                     | 75        | mA               |         |  |         |         |         |         |         |  |  |         |         |         |         |         |  |  |         |         |         |         |         |
| I <sub>L</sub>  | Latching current, typical                       | VD=12V, tp=30µs   | 25                     | 150       | mA               |         |  |         |         |         |         |         |  |  |         |         |         |         |         |  |  |         |         |         |         |         |
| <b>GATE</b>   |   |   |                        |           |                  |         |  |         |         |         |         |         |  |  |         |         |         |         |         |  |  |         |         |         |         |         |
| V <sub>GT</sub>   | Gate trigger voltage                            | VD=5V   | 25                     | 3.5       | V                |         |  |         |         |         |         |         |  |  |         |         |         |         |         |  |  |         |         |         |         |         |
| I <sub>GT</sub>   | Gate trigger current                            | VD=5V   | 25                     | 350       | mA               |         |  |         |         |         |         |         |  |  |         |         |         |         |         |  |  |         |         |         |         |         |
| V <sub>GD</sub>   | Non-trigger gate voltage, min.                  | VD=VDRM   | 125                    | 0.25      | V                |         |  |         |         |         |         |         |  |  |         |         |         |         |         |  |  |         |         |         |         |         |
| V <sub>FGM</sub>  | Peak gate voltage (forward)                     |   | 25                     | 25        | V                |         |  |         |         |         |         |         |  |  |         |         |         |         |         |  |  |         |         |         |         |         |
| I <sub>FGM</sub>  | Peak gate current                               |   | 25                     | 8         | A                |         |  |         |         |         |         |         |  |  |         |         |         |         |         |  |  |         |         |         |         |         |
| V <sub>RGM</sub>  | Peak gate voltage (reverse)                     |   | 25                     | 5         | V                |         |  |         |         |         |         |         |  |  |         |         |         |         |         |  |  |         |         |         |         |         |
| P <sub>GM</sub>   | Peak gate power dissipation                     | Pulse width 100 µs  | 25                     | 100       | W                |         |  |         |         |         |         |         |  |  |         |         |         |         |         |  |  |         |         |         |         |         |
| P <sub>G(AV)</sub>  | Average gate power dissipation                  |   | 25                     | 1         | W                |         |  |         |         |         |         |         |  |  |         |         |         |         |         |  |  |         |         |         |         |         |
| <b>MOUNTING</b>   |   |   |                        |           |                  |         |  |         |         |         |         |         |  |  |         |         |         |         |         |  |  |         |         |         |         |         |
| R <sub>th(j-h)</sub>  | Thermal impedance, DC                           | Junction to heatsink, double side cooled                        |                        | 95        | °C/kW            |         |  |         |         |         |         |         |  |  |         |         |         |         |         |  |  |         |         |         |         |         |
| T <sub>j</sub>  | Operating junction temperature                  |   |                        | -30 / 125 | °C               |         |  |         |         |         |         |         |  |  |         |         |         |         |         |  |  |         |         |         |         |         |
| F   | Mounting force                                  |   |                        | 4.5 / 5.0 | kN               |         |  |         |         |         |         |         |  |  |         |         |         |         |         |  |  |         |         |         |         |         |
|   | Mass  |   |                        | 55        | g                |         |  |         |         |         |         |         |  |  |         |         |         |         |         |  |  |         |         |         |         |         |
| <b>ORDERING INFORMATION : ATF585 S 08 B</b> _____ tq code   |   |   |                        |           |                  |         |  |         |         |         |         |         |  |  |         |         |         |         |         |  |  |         |         |         |         |         |
| standard specification _____ VDRM&VRRM/100  |   |   |                        |           |                  |         |  |         |         |         |         |         |  |  |         |         |         |         |         |  |  |         |         |         |         |         |
| <table> <tr> <td colspan="2">tq code</td> <td>D 10 µs</td> <td>C 12 µs</td> <td>B 15 µs</td> <td>A 20 µs</td> <td>L 25 µs</td> </tr> <tr> <td colspan="2"></td> <td>M 30 µs</td> <td>N 35 µs</td> <td>P 40 µs</td> <td>R 45 µs</td> <td>S 50 µs</td> </tr> <tr> <td colspan="2"></td> <td>T 60 µs</td> <td>U 70 µs</td> <td>W 80 µs</td> <td>X 100µs</td> <td>Y 150µs</td> </tr> </table> |   |   |                        |           |                  | tq code |  | D 10 µs | C 12 µs | B 15 µs | A 20 µs | L 25 µs |  |  | M 30 µs | N 35 µs | P 40 µs | R 45 µs | S 50 µs |  |  | T 60 µs | U 70 µs | W 80 µs | X 100µs | Y 150µs |
| tq code   |   | D 10 µs   | C 12 µs                | B 15 µs   | A 20 µs          | L 25 µs |  |         |         |         |         |         |  |  |         |         |         |         |         |  |  |         |         |         |         |         |
|   |   | M 30 µs   | N 35 µs                | P 40 µs   | R 45 µs          | S 50 µs |  |         |         |         |         |         |  |  |         |         |         |         |         |  |  |         |         |         |         |         |
|   |   | T 60 µs   | U 70 µs                | W 80 µs   | X 100µs          | Y 150µs |  |         |         |         |         |         |  |  |         |         |         |         |         |  |  |         |         |         |         |         |

## SWITCHING CHARACTERISTICS

REVERSE RECOVERY CHARGE  
 $T_j = 125\text{ }^\circ\text{C}$

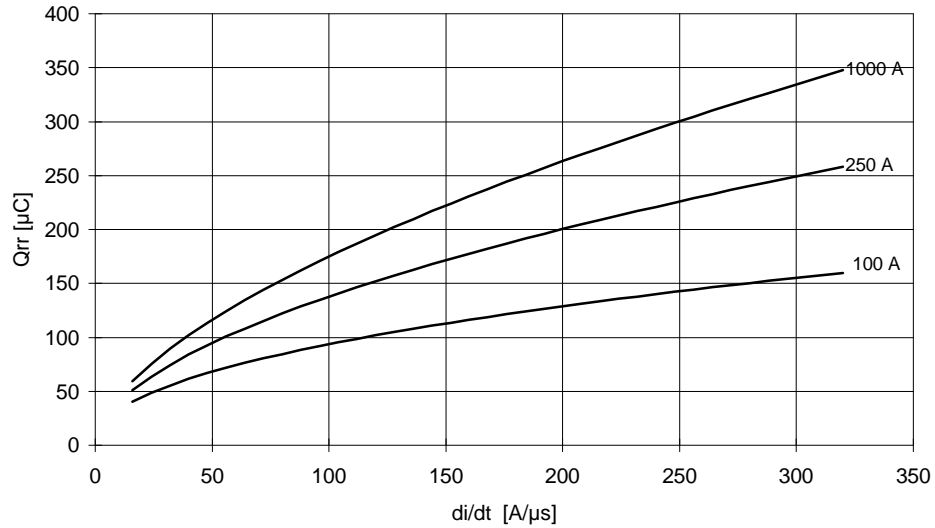

REVERSE RECOVERY CURRENT  
 $T_j = 125\text{ }^\circ\text{C}$

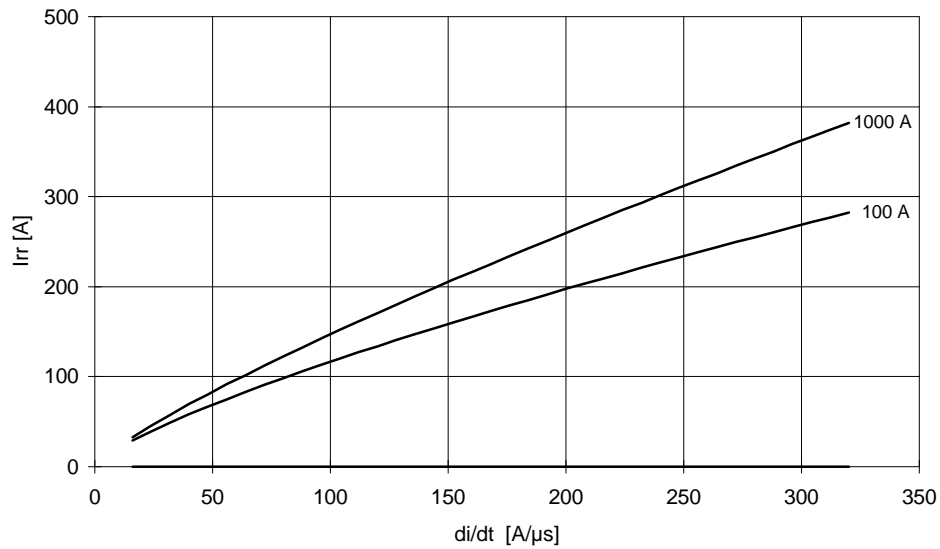

$$t_a = I_{rr} / (di/dt) \quad t_b = t_{rr} - t_a$$

$$\text{Softness (s factor)} \quad s = t_b / t_a$$

$$\text{Energy dissipation during recovery } E_r = V_r \cdot (Q_{rr} - I_{rr} \cdot t_a / 2)$$

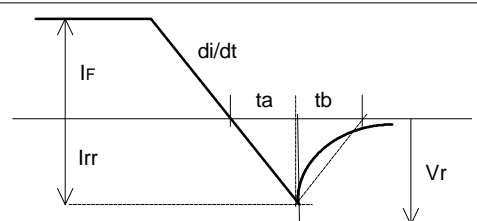

ON-STATE CHARACTERISTIC  
T<sub>j</sub> = 125 °C

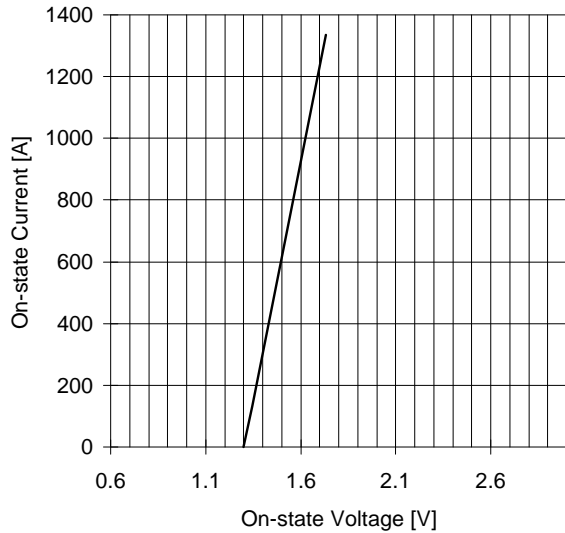

SURGE CHARACTERISTIC  
T<sub>j</sub> = 125 °C

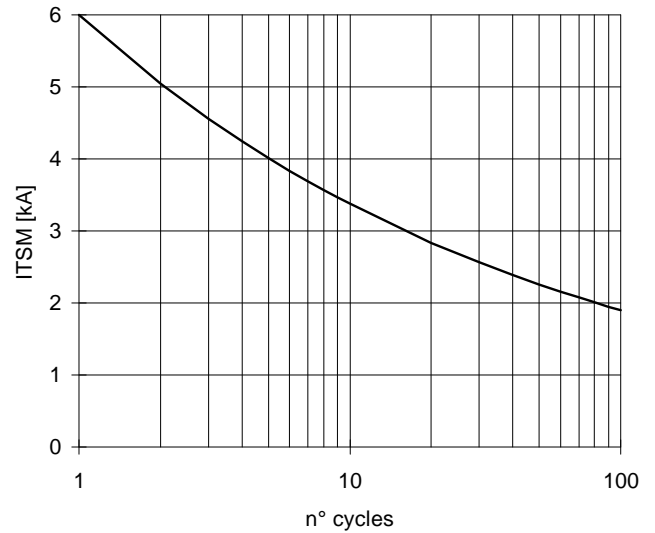

TRANSIENT THERMAL IMPEDANCE  
DOUBLE SIDE COOLED

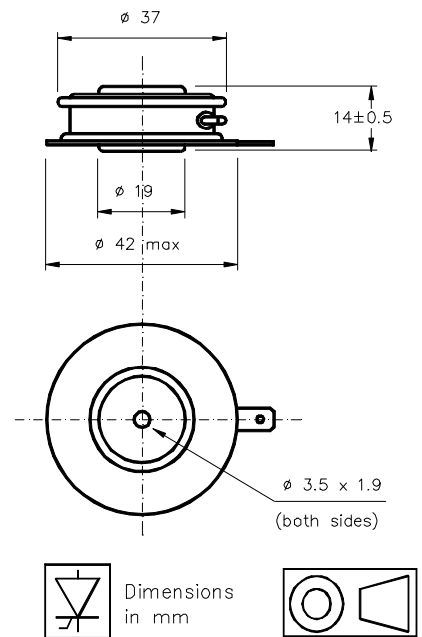
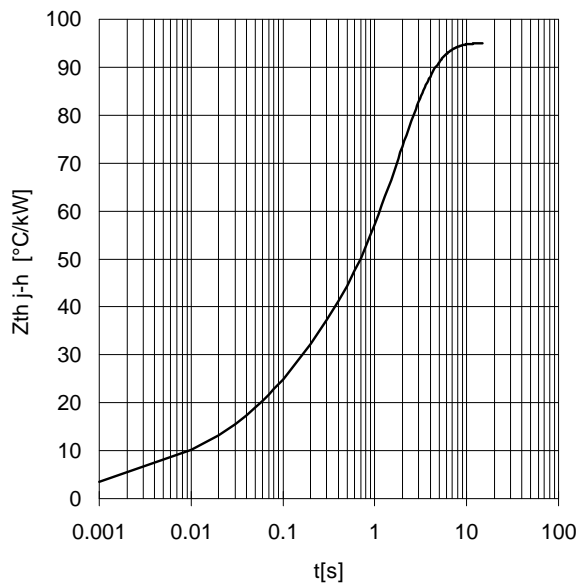

Cathode terminal type DIN 46244 - A 4.8 - 0.8

Gate terminal type AMP 60598 - 1

Distributed by

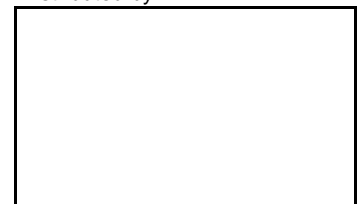

All the characteristics given in this data sheet are guaranteed only with uniform clamping force, cleaned and lubricated heatsink, surfaces with flatness < .03 mm and roughness < 2 µm.

In the interest of product improvement ANSALDO reserves the right to change any data given in this data sheet at any time without previous notice.

If not stated otherwise the maximum value of ratings (symbols over shaded background) and characteristics is reported.