

**POSEICO**

POSEICO SPA

POwer SEmiconductors Italian COrporation

POSEICO SPA

Via N. Lorenzi 8, 16152 Genova - ITALY

Tel. ++ 39 010 6556234 - Fax ++ 39 010 6557519

Sales Office:

Tel. ++ 39 010 6556775 - Fax ++ 39 010 6442510

**RECTIFIER DIODE****AR242**

Repetitive voltage up to

**2200 V**

Mean forward current

**830 A**

Surge current

**6.5 kA****FINAL SPECIFICATION**

nov 02 - ISSUE : 02

Symbol	Characteristic	Conditions	T <sub>j</sub> [°C]	Value	Unit
<b>BLOCKING</b>					
V <sub>RRM</sub>	Repetitive peak reverse voltage		175	2200	V
V <sub>RSM</sub>	Non-repetitive peak reverse voltage		175	2300	V
I <sub>RRM</sub>	Repetitive peak reverse current	V=VRRM	175	50	mA
<b>CONDUCTING</b>					
I <sub>F(AV)</sub>	Mean forward current	180° sin ,50 Hz, Th=55°C, double side cooled		830	A
I <sub>F(AV)</sub>	Mean forward current	180° sin ,50 Hz, Tc=85°C, double side cooled		805	A
I <sub>FSM</sub>	Surge forward current	Sine wave, 10 ms without reverse voltage	175	6.5	kA
I <sup>2</sup> t	I <sup>2</sup> t			211 x 1E3	A <sup>2</sup> s
V <sub>FM</sub>	Forward voltage	Forward current = 1000 A	25	1.40	V
V <sub>F(TO)</sub>	Threshold voltage		175	0.70	V
r <sub>F</sub>	Forward slope resistance		175	0.400	mohm
<b>SWITCHING</b>					
t <sub>rr</sub>	Reverse recovery time				μs
Q <sub>rr</sub>	Reverse recovery charge		175		μC
I <sub>rr</sub>	Peak reverse recovery current				A
<b>MOUNTING</b>					
R <sub>th(j-h)</sub>	Thermal impedance, DC	Junction to heatsink, double side cooled		95	°C/kW
R <sub>th(c-h)</sub>	Thermal impedance	Case to heatsink, double side cooled		20	°C/kW
T <sub>j</sub>	Operating junction temperature			-30 / 175	°C
F	Mounting force			4.5 / 5.0	kN
	Mass			55	g

**ORDERING INFORMATION : AR242 S 22**standard specification   VRRM/100

## DISSIPATION CHARACTERISTICS

SQUARE WAVE

Th [°C]

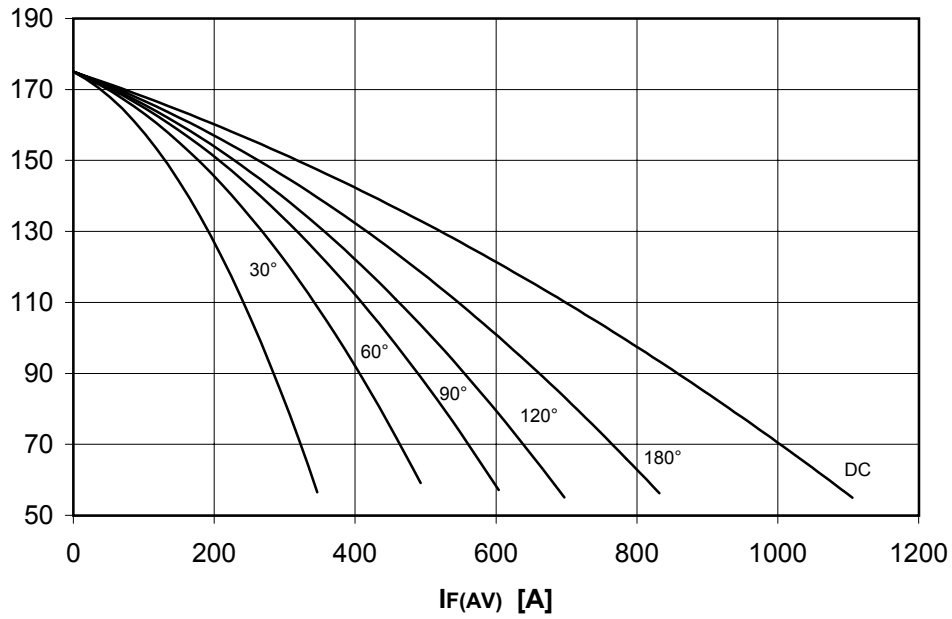

PF(AV) [W]

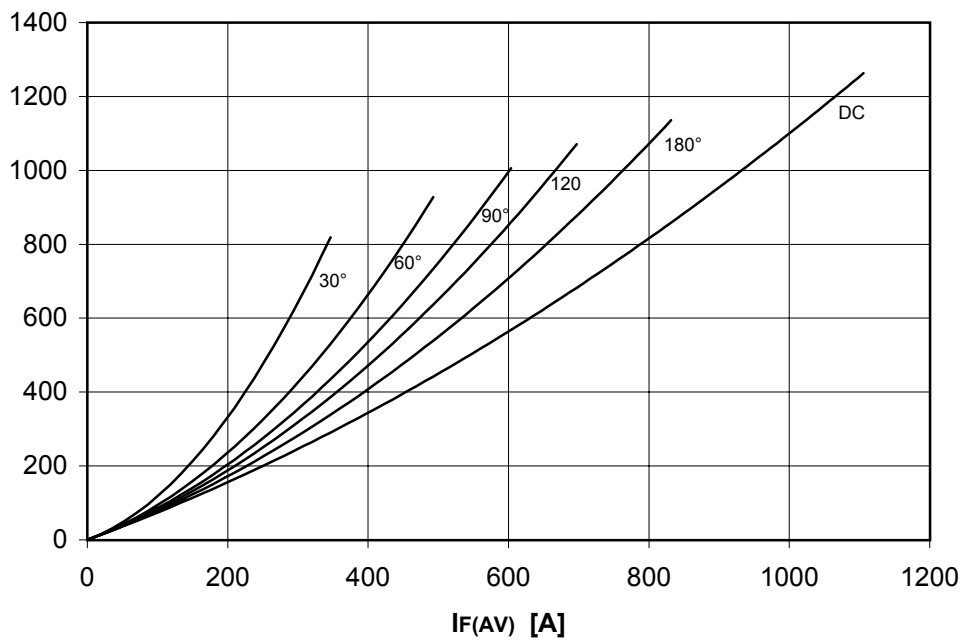

## DISSIPATION CHARACTERISTICS

SINE WAVE

Th [°C]

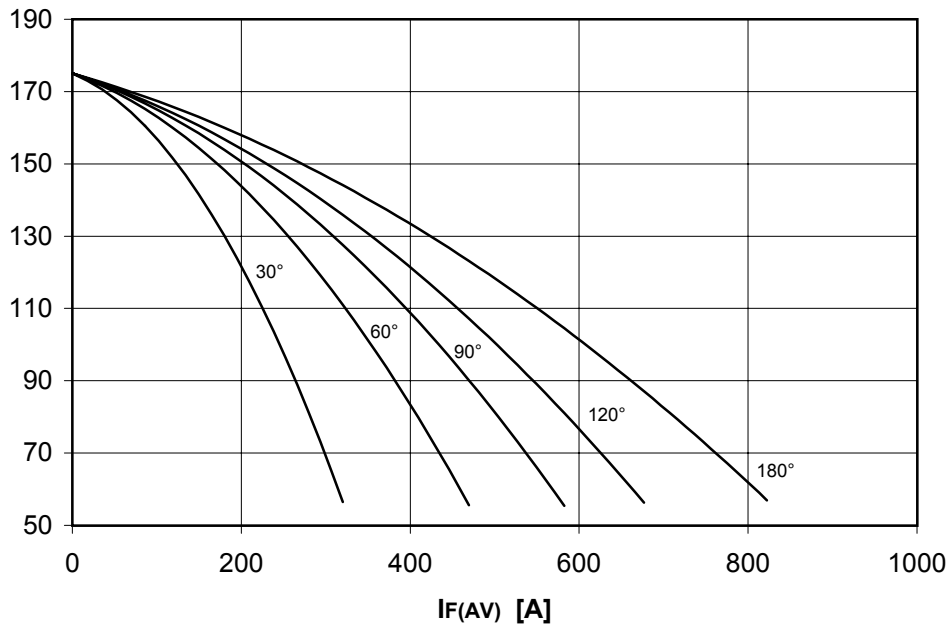

PF(AV) [W]

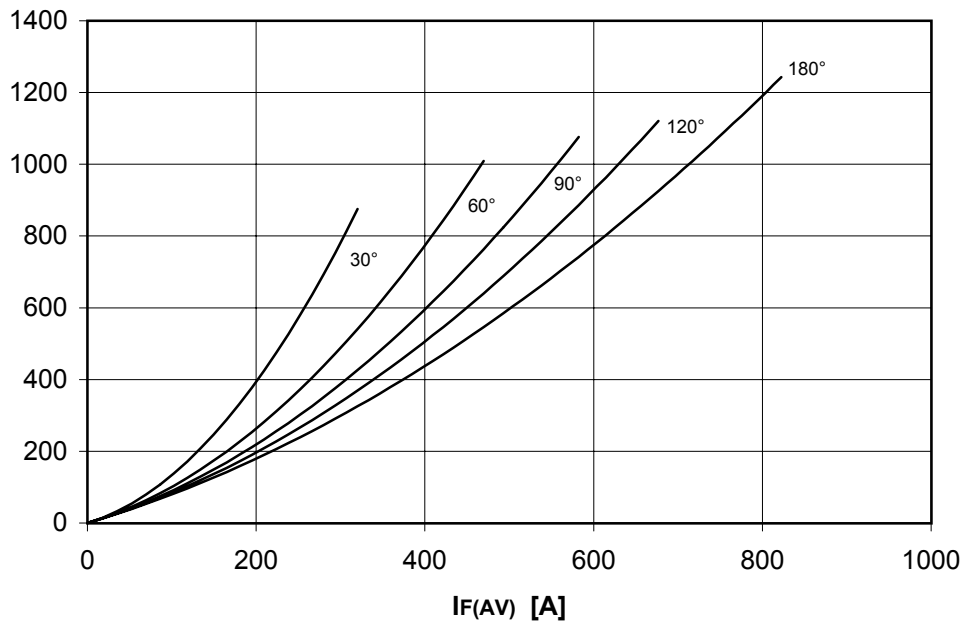

# AR242 RECTIFIER DIODE

FINAL SPECIFICATION nov 02 - ISSUE : 02

**FORWARD CHARACTERISTIC**  
T<sub>j</sub> = 175 °C

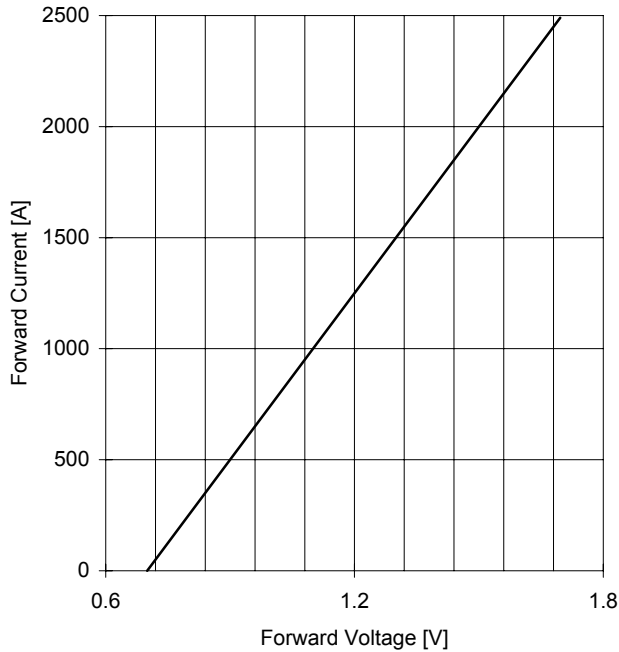

**SURGE CHARACTERISTIC**  
T<sub>j</sub> = 175 °C

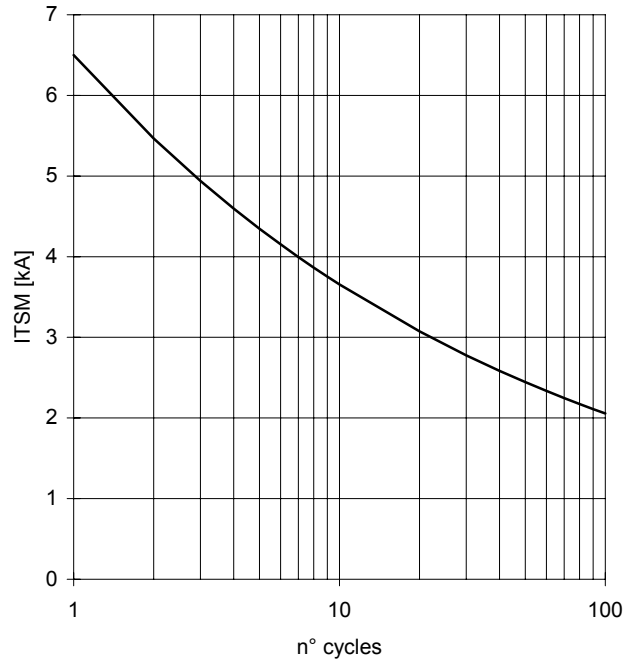

**TRANSIENT THERMAL IMPEDANCE**  
DOUBLE SIDE COOLED

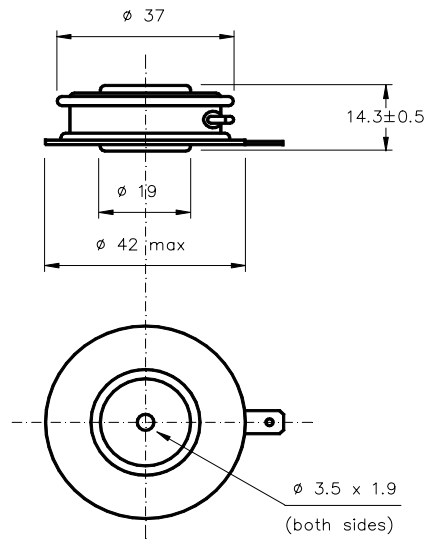
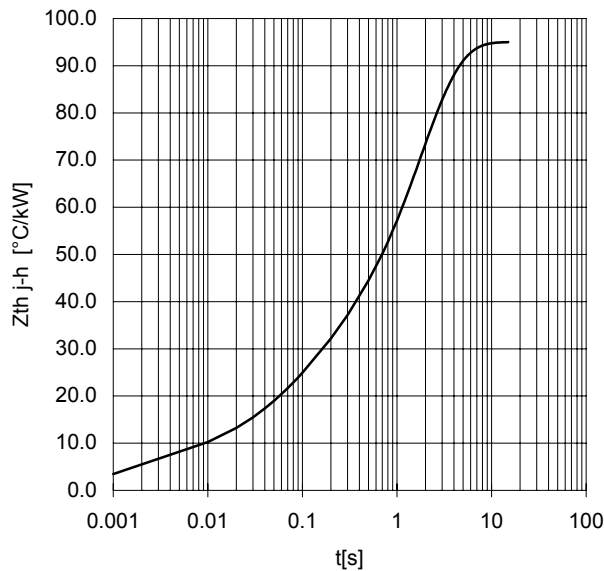

Dimensions in mm

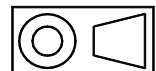

All the characteristics given in this data sheet are guaranteed only with uniform clamping force, cleaned and lubricated heatsink, surfaces with flatness < .03 mm and roughness < 2 μm.  
In the interest of product improvement POSEICO SpA reserves the right to change any data given in this data sheet at any time without previous notice.  
If not stated otherwise the maximum value of ratings (symbols over shaded background) and characteristics is reported.

Distributed by

