

3-Terminal Negative Output Voltage Regulators

These voltage regulators are intended as complements to the popular PJ7900B Series devices. These negative regulators are available in the same seven-voltage options as the PJ7900B Series devices. In addition, one extra voltage option commonly employed in MECL systems is also available in the negative PJ7900B Series.

Available in fixed output voltage options from -5.0 to -24 volts, these regulators employ current limiting, thermal shutdown, and safe-area compensation--making them remarkably rugged under most operating conditions. With adequate heatsinking they can deliver output currents in excess of 1 ampere.

FEATURES

- Output Current up to 1 Ampere
- No External Components Required
- Internal Thermal Overload Protection
- Internal Short-Circuit Current Limiting
- Output Transistor Safe-Area Compensation
- Available in 4% Voltage Tolerance

ORDERING INFORMATION

Device	Operating Temperature (Ambient)	Package
PJ79xxBCZ	0 °C to +70°C	TO-220
PJ79xxBCI		TO-220F

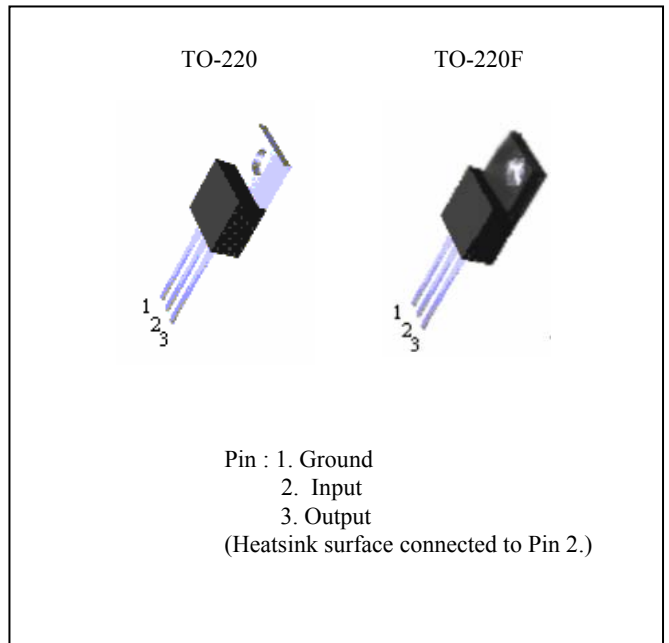

CIRCUIT SCHEMATIC

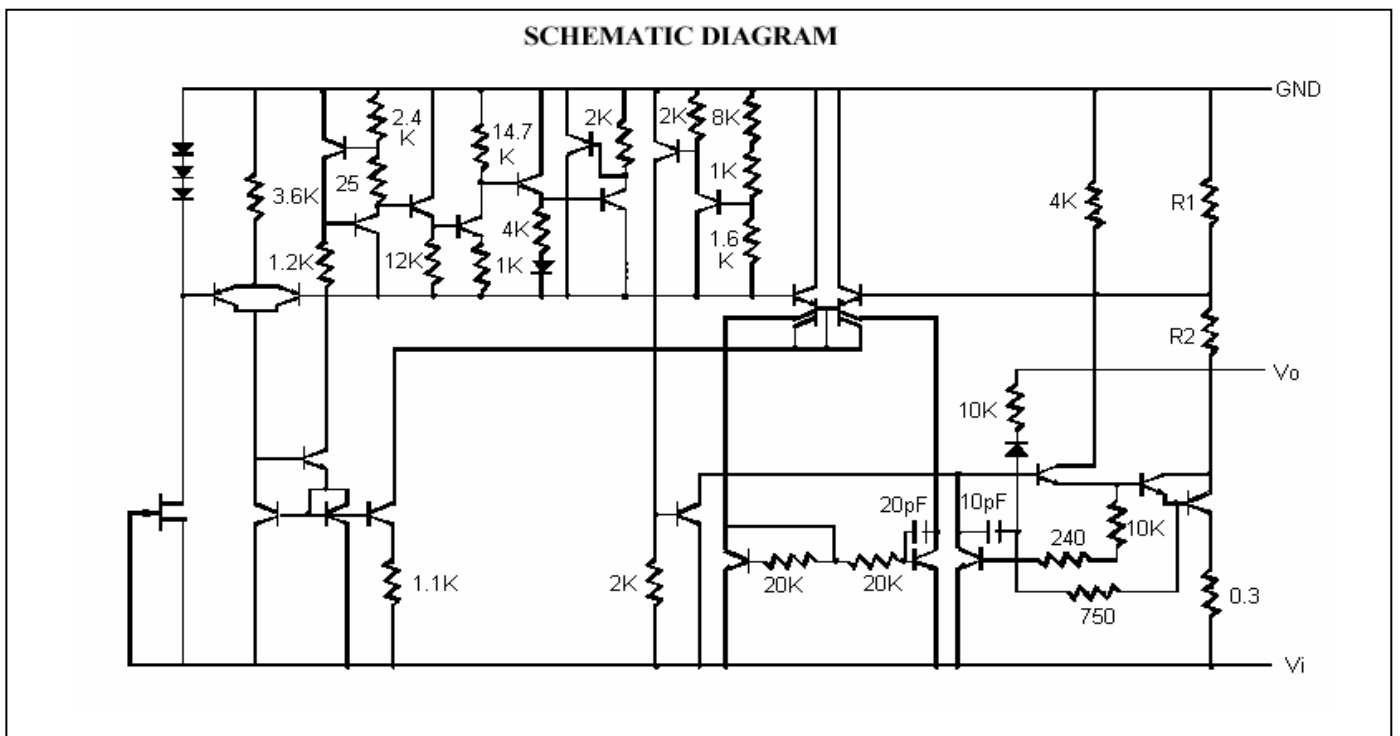

3-Terminal Negative Output Voltage Regulators

ABSOLUTE MAXIMUM RATINGS (Ta=25°C)

RATING	SYMBOL	PJ7900 Series	UNIT
Input Voltage *(-5V ≥ Vo ≥ -18V) **(-24V)	Vin	-35 -40	V
Power Dissipation TO-220	Without heatsink	2	°C/W
TO-220	Pt ***	15	
TO-220F	With heatsink	10	
Operating Ambient Temperature	Topr	-0 to +70	°C
Operating Junction Temperature	Tj	0 to +125	°C
Storage Temperature	Tstg	-25 to +150	°C

Note: *1: PJ7905B to PJ7918B

**2: PJ7924B

***3: Follow the derating curve. When Tj exceeds 150°C, the internal circuit cuts off the output.

PJ7905B ELECTRICAL CHARACTERISTICS

(Vin=-10V, Iout=500mA, Cin=2 μF, Cout=1 μF; Tj=0°C to 125°C, unless otherwise specified.)

CHARACTERISTIC	SYMBOL	TEST CIRCUIT	CONDITION	MIN.	TYP.	MAX	UNIT	
Output Voltage	Vo	1	Tj=25°C	-4.80	-5.0	-5.20	V	
			Vi=-7 to -20V, Io=5mA to 1A, Pp<15W	-4.75	-5.0	-5.25	V	
Line Regulation	REGline	1	Tj=25°C	Vi=-7 to -25V	--	3	100	mV
				Vi=-8 to -12V	--	1	50	mV
Load Regulation	REGload	1	Tj=25°C	Io=5mA to 1A	--	10	100	mV
				Io=250mA to 750mA	--	3	50	mV
Quiescent Current	Iq	2	Tj=25°C	--	2	4	mA	
Quiescent current Change	Δ Iq	2	VIN=-7 to -25V Io=5mA to 1A	--	--	1.3	mA	
						0.5		
Output Noise Voltage	Vn	1	f=10Hz to 100KHz, Ta=25°C	--	40	--	μV	
Ripple Rejection Ratio	RR	3	Vi=-8 to -18V, Io=100mA, f=120Hz	62	74	--	dB	
Min. I/O Voltage Difference	Vdif		Io=1A, Tj=25°C	--	1.1	--	V	
Peak Output Current	Io-peak	1	Tj=25°C	--	2.1	--	A	
Output Voltage Temperature Coefficient	Δ Vo/Ta	1	Io=5mA, Tj=0 to 125°C	--	-0.4	--	mV/°C	

Note: The specified condition Tj=25°C means that the test should be carried out with the test time so short (within 10mS), that the drift in characteristic value due to the rise in chip junction temperature can be ignored.

STANDARD APPLICATION

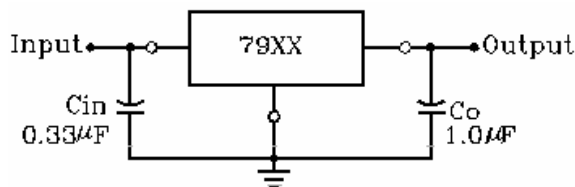

A common ground is required between the input and the output voltages. The input voltage must remain typically 2.0 V more negative even during the high point on the input ripple voltage.

XX = these two digits of the type number indicate voltage.

* = Cin is required if regulator is located an appreciable distance from power supply filter.

** = Co improves stability and transient response.

3-Terminal Negative Output Voltage Regulators

• PJ7906B ELECTRICAL CHARACTERISTICS

(Vin=-11V, Iout=500mA, Cin=2 μF, Cout=1 μF; Tj=0°C to 125°C, unless otherwise specified.)

CHARACTERISTIC	SYMBOL	TEST CIRCUIT	CONDITION	MIN.	TYP.	MAX.	UNIT	
Output Voltage	Vo	1	Tj=25°C	-5.75	-6.0	-6.25	V	
			Vi=-8 to -21V, Io=5mA to 1A, Pp<15W	-5.70	-6.0	-6.30	V	
Line Regulation	REGline	1	Tj=25°C	Vi=-8 to -25V	--	4	120	mV
				Vi=-9 to -13V	--	1.5	60	mV
Load Regulation	REGload	1	Tj=25°C	Io=5mA to 1A	--	10	120	mV
				Io=250mA to 750mA	--	3	60	mV
Quiescent Current	Iq	2	Tj=25°C	--	2	4	mA	
Quiescent Current Change	Δ Iq	2	Vi=-8 to -25V, Tj=25°C	--	--	1.3	mA	
			Io=5mA to 1A, Tj=25°C	--	--	0.5	mA	
Output Noise Voltage	Vn	1	f=10Hz to 100KHz, Ta=25°C	--	44	--	μV	
Ripple Rejection Ratio	RR	3	Vi=-9 to -19V, Io=100mA, f=120Hz	60	73	--	dB	
Min. I/O Voltage Difference	Vdif		Io=1A, Tj=25°C	--	1.1	--	V	
Peak Output Current	Io-peak	1	Tj=25°C	--	2.1	--	A	
Output Voltage Temperature Coefficient	Δ Vo/Ta	1	Io=5mA, Tj=0 to 125°C	--	-0.5	--	mV/°C	

Note: The specified condition Tj=25°C means that the test should be carried out with the test time so short (within 10mS), that the drift in characteristic value due to the rise in chip junction temperature can be ignored.

• PJ7908B ELECTRICAL CHARACTERISTICS

(Vin=-14V, Iout=500mA, Cin=2 μF, Cout=1 μF; Tj=0°C to 125°C, unless otherwise specified.)

CHARACTERISTIC	SYMBOL	TEST CIRCUIT	CONDITION	MIN.	TYP.	MAX.	UNIT	
Output Voltage	Vo	1	Tj=25°C	-7.69	-8.0	-8.32	V	
			Vi=-10.5 to -23V, Io=5mA to 1A, Pp<15W	-7.61	-8.0	-8.40	V	
Line Regulation	REGline	1	Tj=25°C	Vi=-10.5 to -25V	--	6	160	mV
				Vi=-11 to -17V	--	2	80	mV
Load Regulation	REGload	1	Tj=25°C	Io=5mA to 1A	--	12	160	mV
				Io=250mA to 750mA	--	4	80	mV
Quiescent Current	Iq	2	Tj=25°C	--	2	4	mA	
Quiescent Current Change	Δ Iq	2	Vi=-10.5 to -25V, Tj=25°C	--	--	1	mA	
			Io=5mA to 1A	--	--	0.5	mA	
Output Noise Voltage	Vn	1	f=10Hz to 100KHz, Ta=25°C	--	52	--	μV	
Ripple Rejection Ratio	RR	3	Vi=-11 to -21V, Io=100mA, f=120Hz	56	71	--	dB	
Min. I/O Voltage Difference	Vdif		Io=1A, Tj=25°C	--	2	--	V	
Peak Output Current	Io-peak	1	Tj=25°C	--	2.1	--	A	
Output Voltage Temperature Coefficient	Δ Vo/Ta	1	Io=5mA, Tj=0 to 125°C	--	-0.6	--	mV/°C	

Note: The specified condition Tj=25°C means that the test should be carried out with the test time so short (within 10mS), that the drift in characteristic value due to the rise in chip junction temperature can be ignored.

3-Terminal Negative Output Voltage Regulators

PJ7909B ELECTRICAL CHARACTERISTICS

($V_{in}=-15V$, $I_{out}=500mA$, $C_{in}=2\mu F$, $C_{out}=1\mu F$; $T_j=0^\circ C$ to $125^\circ C$, unless otherwise specified.)

CHARACTERISTIC	SYMBOL	TEST CIRCUIT	CONDITION	MIN.	TYP.	MAX.	UNIT	
Output Voltage	V_o	1	$T_j=25^\circ C$	-8.65	-9.0	-9.36	V	
			$V_i=-11.5$ to $-24V$, $I_o=5mA$ to $1A$, $P_D<15W$	-8.57	-9.0	-9.45	V	
Line Regulation	REGline	1	$T_j=25^\circ C$	$V_i=-11.5$ to $-26V$	--	7	180	mV
				$V_i=-12$ to $-18V$	--	2	90	mV
Load Regulation	REGload	1	$T_j=25^\circ C$	$I_o=5mA$ to $1A$	--	12	180	mV
				$I_o=250mA$ to $750mA$	--	4	90	mV
Quiescent Current	I_q	2	$T_j=25^\circ C$	--	2.2	4.5	mA	
Quiescent Current Change	ΔI_q	2	$V_i=-11.5$ to $-26V$, $T_j=25^\circ C$	--	--	1	mA	
			$I_o=5mA$ to $1A$	--	--	0.5	mA	
Bias Current	I_{IB}	2	$T_j=25^\circ C$	--	2.2	4.5	mA	
Output Noise Voltage	V_n	1	$f=10Hz$ to $100KHz$, $T_a=25^\circ C$	--	58	--	μV	
Ripple Rejection Ratio	RR	3	$V_i=-12$ to $-22V$, $I_o=100mA$, $f=120Hz$	56	71	--	dB	
Min. I/O Voltage Difference	V_{dif}		$I_o=1A$, $T_j=25^\circ C$	--	1.1	--	V	
Peak Output Current	$I_o\text{-peak}$	1	$T_j=25^\circ C$	--	2.1	--	A	
Output Voltage Temperature Coefficient	$\Delta V_o/T_a$	1	$I_o=5mA$, $T_j=0$ to $125^\circ C$	--	-0.6	--	mV/ $^\circ C$	

Note: The specified condition $T_j=25^\circ C$ means that the test should be carried out with the test time so short (within 10mS), that the drift in characteristic value due to the rise in chip junction temperature can be ignored.

PJ7912B ELECTRICAL CHARACTERISTICS

($V_{in}=-19V$, $I_{out}=500mA$, $C_{in}=2\mu F$, $C_{out}=1\mu F$; $T_j=0^\circ C$ to $125^\circ C$, unless otherwise specified.)

CHARACTERISTIC	SYMBOL	TEST CIRCUIT	CONDITION	MIN.	TYP.	MAX.	UNIT	
Output Voltage	V_o	1	$T_j=25^\circ C$	-11.53	-12	-12.48	V	
			$V_i=-14.5$ to $-27V$, $I_o=5mA$ to $1A$, $P_D<15W$	-11.42	-12	-12.60	V	
Line Regulation	REGline	1	$T_j=25^\circ C$	$V_i=-14.5$ to $-30V$	--	10	240	mV
				$V_i=-16$ to $-22V$	--	3	120	mV
Load Regulation	REGload	1	$T_j=25^\circ C$	$I_o=5mA$ to $1A$	--	12	240	mV
				$I_o=250mA$ to $750mA$	--	4	120	mV
Quiescent Current	I_q	2	$T_j=25^\circ C$	--	2.5	5	mA	
Quiescent Current Change	ΔI_q	2	$V_i=-14.5$ to $-30V$, $T_j=25^\circ C$	--	--	1	mA	
			$I_o=5mA$ to $1A$	--	--	0.5	mA	
Output Noise Voltage	V_n	1	$f=10Hz$ to $100KHz$, $T_a=25^\circ C$	--	75	--	μV	
Ripple Rejection Ratio	RR	3	$V_i=-15$ to $-25V$, $I_o=100mA$, $f=120Hz$	55	70	--	dB	
Min. I/O Voltage Difference	V_{dif}		$I_o=1A$, $T_j=25^\circ C$	--	1.1	--	V	
Peak Output Current	$I_o\text{-peak}$	1	$T_j=25^\circ C$	--	2.1	--	A	
Output Voltage Temperature Coefficient	$\Delta V_o/T_a$	1	$I_o=5mA$, $T_j=0$ to $125^\circ C$	--	-0.8	--	mV/ $^\circ C$	

Note: The specified condition $T_j=25^\circ C$ means that the test should be carried out with the test time so short (within 10mS), that the drift in characteristic value due to the rise in chip junction temperature can be ignored.

3-Terminal Negative Output Voltage Regulators

PJ7915B ELECTRICAL CHARACTERISTICS

($V_{in}=-23V$, $I_{out}=500mA$, $C_{in}=2\mu F$, $C_{out}=1\mu F$; $T_j=0^\circ C$ to $125^\circ C$, unless otherwise specified.)

CHARACTERISTIC	SYMBOL	TEST CIRCUIT	CONDITION	MIN.	TYP.	MAX.	UNIT	
Output Voltage	V_o	1	$T_j=25^\circ C$	-14.42	-15	-15.60	V	
			$V_i=-17.5$ to $-30V$, $I_o=5mA$ to $1A$, $P_D<15W$	-14.28	-15	-15.75	V	
Line Regulation	REGline	1	$T_j=25^\circ C$	$V_i=-17.5$ to $-30V$	--	11	300	mV
				$V_i=-20$ to $-26V$	--	3	150	mV
Load Regulation	REGload	1	$T_j=25^\circ C$	$I_o=5mA$ to $1A$	--	12	300	mV
				$I_o=250mA$ to $750mA$	--	4	150	mV
Quiescent Current	I_q	2	$T_j=25^\circ C$	--	2.5	5	mA	
Quiescent Current Change	ΔI_q	2	$V_i=-17.5$ to $-30V$ $I_o=5mA$ to $1A$	--	--	1	mA	
				--	--	0.5	mA	
Output Noise Voltage	V_n	1	$f=10Hz$ to $100KHz$, $T_a=25^\circ C$	--	90	--	μV	
Ripple Rejection Ratio	RR	3	$V_i=-18.5$ to $-28.5V$, $I_o=100mA$, $f=120Hz$	54	69	--	dB	
Min. I/O Voltage Difference	V_{dif}		$I_o=1A$, $T_j=25^\circ C$	--	1.1	--	V	
Peak Output Current	I_{o-peak}	1	$T_j=25^\circ C$	--	2.1	--	A	
Output Voltage Temperature Coefficient	$\Delta V_o/T_a$	1	$I_o=5mA$, $T_j=0$ to $125^\circ C$	--	-0.9	--	$mV/^\circ C$	

Note: The specified condition $T_j=25^\circ C$ means that the test should be carried out with the test time so short (within 10mS), that the drift in characteristic value due to the rise in chip junction temperature can be ignored.

PJ7918B ELECTRICAL CHARACTERISTICS

($V_{in}=-27V$, $I_{out}=500mA$, $C_{in}=2\mu F$, $C_{out}=1\mu F$; $T_j=0^\circ C$ to $125^\circ C$, unless otherwise specified.)

CHARACTERISTIC	SYMBOL	TEST CIRCUIT	CONDITION	MIN.	TYP.	MAX.	UNIT	
Output Voltage	V_o	1	$T_j=25^\circ C$	-17.30	-18	-18.72	V	
			$V_i=-21$ to $-33V$, $I_o=5mA$ to $1A$, $P_D<15W$	-17.14	-18	-18.90	V	
Line Regulation	REGline	1	$T_j=25^\circ C$	$V_i=-21$ to $-33V$	--	15	360	mV
				$V_i=-24$ to $-30V$	--	5	180	mV
Load Regulation	REGload	1	$T_j=25^\circ C$	$I_o=5mA$ to $1A$	--	12	360	mV
				$I_o=250mA$ to $750mA$	--	4	180	mV
Quiescent Current	I_q	2	$T_j=25^\circ C$	--	2.5	5	mA	
Quiescent Current Change	ΔI_q	2	$V_i=-21$ to $-33V$, $T_j=25^\circ C$ $I_o=5mA$ to $1A$, $T_j=25^\circ C$	--	--	1	mA	
				--	--	0.5	mA	
Output Noise Voltage	V_n	1	$f=10Hz$ to $100KHz$, $T_a=25^\circ C$	--	110	--	μV	
Ripple Rejection Ratio	RR	3	$V_i=-22$ to $-32V$, $I_o=100mA$, $f=120Hz$	53	68	--	dB	
Min. I/O Voltage Difference	V_{dif}		$I_o=1A$, $T_j=25^\circ C$	--	1.1	--	V	
Peak Output Current	I_{o-peak}	1	$T_j=25^\circ C$	--	2.1	--	A	
Output Voltage Temperature Coefficient	$\Delta V_o/T_a$	1	$I_o=5mA$, $T_j=0$ to $125^\circ C$	--	-1	--	$mV/^\circ C$	

Note: The specified condition $T_j=25^\circ C$ means that the test should be carried out with the test time so short (within 10mS), that the drift in characteristic value due to the rise in chip junction temperature can be ignored.

3-Terminal Negative Output Voltage Regulators

PJ7924B ELECTRICAL CHARACTERISTICS

($V_{in}=-33V$, $I_{out}=500mA$, $C_{in}=2\mu F$, $C_{out}=1\mu F$; $T_j=0^\circ C$ to $125^\circ C$, unless otherwise specified.)

CHARACTERISTIC	SYMBOL	TEST CIRCUIT	CONDITION	MIN.	TYP.	MAX.	UNIT	
Output Voltage	V_o	1	$T_j=25^\circ C$	-23.07	-24	-24.96	V	
			$V_i=-27$ to $-38V$, $I_o=5mA$ to $1A$, $P_D<15W$	-22.85	-24	-25.20	V	
Line Regulation	REGline	1	$T_j=25^\circ C$	$V_i=-27$ to $-38V$	--	18	480	mV
				$V_i=-30$ to $-36V$	--	6	240	mV
Load Regulation	REGload	1	$T_j=25^\circ C$	$I_o=5mA$ to $1A$	--	12	480	mV
				$I_o=250mA$ to $750mA$	--	4	240	mV
Quiescent Current	I_q	2	$T_j=25^\circ C$	--	3	5	mA	
Quiescent Current Change	ΔI_q	2	$V_i=-27$ to $-38V$, $T_j=25^\circ C$	--	--	1	mA	
			$I_o=5mA$ to $1A$, $T_j=25^\circ C$	--	--	0.5	mA	
Output Noise Voltage	V_n	1	$f=10Hz$ to $100KHz$, $T_a=25^\circ C$	--	170	--	μV	
Ripple Rejection Ratio	RR	3	$V_i=-28$ to $-38V$, $I_o=100mA$, $f=120Hz$	50	65	--	dB	
Min. I/O Voltage Difference	V_{dif}		$I_o=1A$, $T_j=25^\circ C$	--	1.1	--	V	
Peak Output Current	I_{o-peak}	1	$T_j=25^\circ C$	--	2.1	--	A	
Output Voltage Temperature Coefficient	$\Delta V_o/T_a$	1	$I_o=5mA$, $T_j=0$ to $125^\circ C$	--	-1	--	$mV/^\circ C$	

Note: The specified condition $T_j=25^\circ C$ means that the test should be carried out with the test time so short (within 10mS), that the drift in characteristic value due to the rise in chip junction temperature can be ignored.

TEST CIRCUIT 1

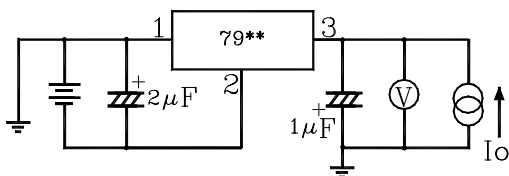

TEST CIRCUIT 2

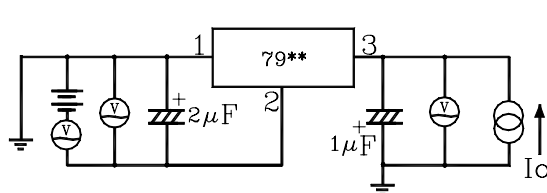

TEST CIRCUIT 3

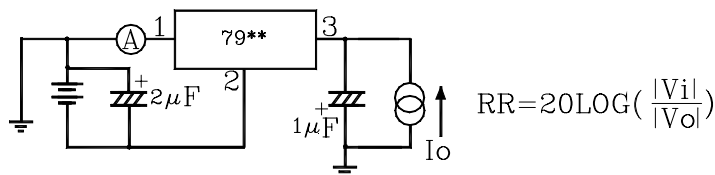

3-Terminal Negative Output Voltage Regulators

FIGURE 1 - WORST CASE POWER DISSIPATION FIGURE AS A FUNCTION OF AMBIENT TEMPERATURE

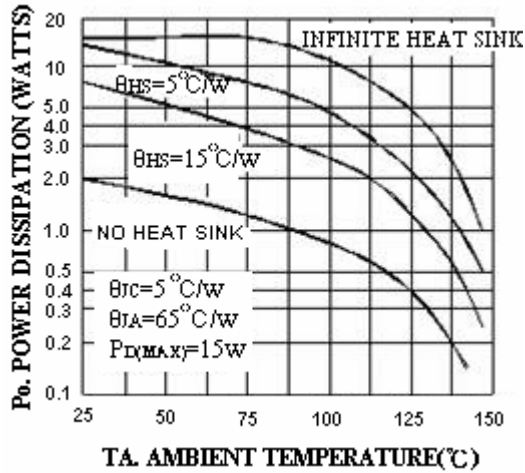

2 - WORST CASE POWER DISSIPATION AS FUNCTION OF AMBIENT TEMPERATURE

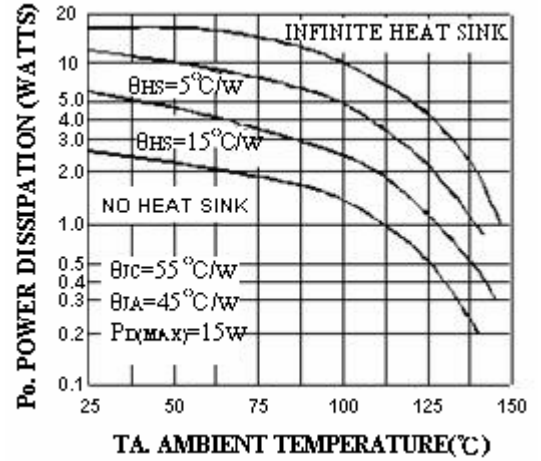
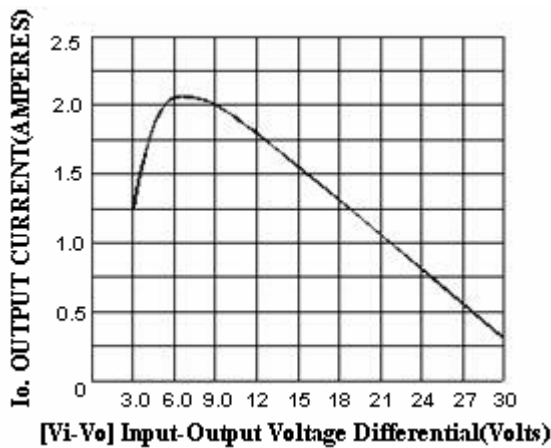

FIGURE 3 - PEAK OUTPUT CURRENT AS A FUNCTION OF INPUT-OUTPUT DIFFERENTIAL VOLTAGE



4 - RIPPLE REJECTION AS A FUNCTION OF FREQUENCY

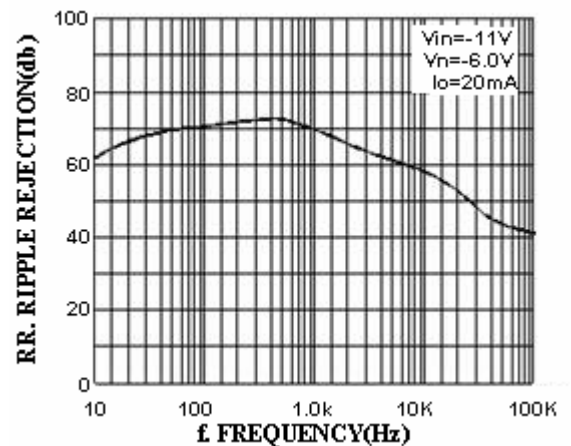
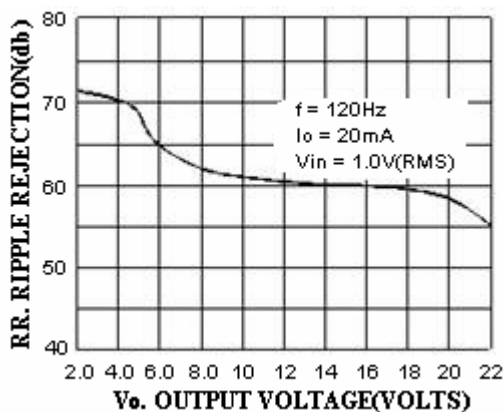
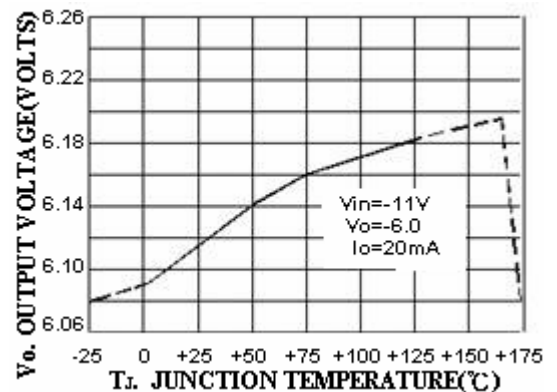

FIGURE 5 - RIPPLE REJECTION AS A FUNCTION OF OUTPUT VOLTAGES



6 - OUTPUT VOLTAGE AS A FUNCTION OF JUNCTION TEMPERATURE



TO-220 Unit : mm

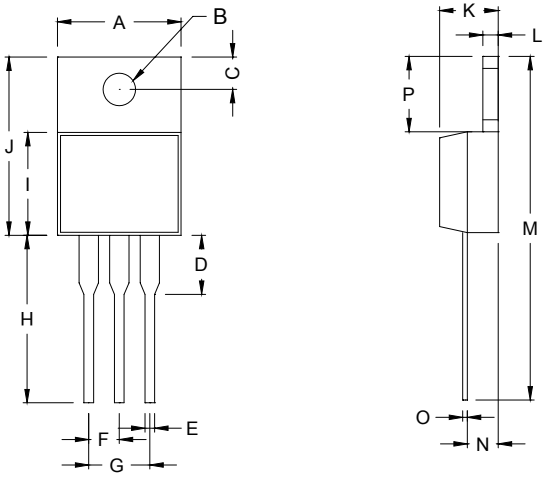

TO-220 DIMENSION				
DIM	MILLIMETERS		INCHES	
	MIN	MAX	MIN	MAX
A	10.000	10.500	0.394	0.413
B	3.240	4.440	0.128	0.175
C	2.440	2.940	0.096	0.116
D	-	6.350	-	0.250
E	0.381	1.106	0.015	0.040
F	2.345	2.715	0.092	0.058
G	4.690	5.430	0.092	0.107
H	12.700	14.732	0.500	0.581
I	8.382	9.017	0.330	0.355
J	14.224	16.510	0.560	0.650
K	3.556	4.826	0.140	0.190
L	0.508	1.397	0.020	0.055
M	27.700	29.620	1.060	1.230
N	2.032	2.921	0.080	0.115
O	0.255	0.610	0.010	0.024
P	5.842	6.858	0.230	0.270

TO-220F Unit : mm

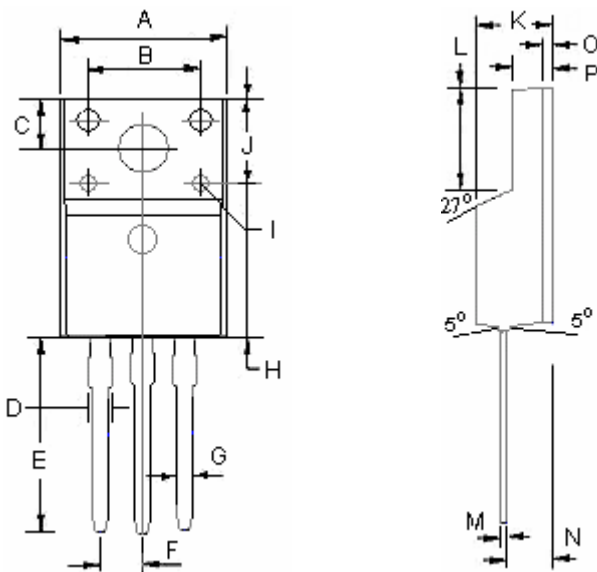

TO-220F DIMENSION				
DIM	MILLIMETERS		INCHES	
	MIN	MAX	MIN	MAX
A	9.960	10.36	0.392	0.408
B	6.800	7.200	0.268	0.283
C	3.100	3.500	0.122	0.138
D	1.470		0.059	
E	12.60	13.00	0.496	0.512
F	2.340	2.740	0.092	0.108
G	0.600	1.000	0.024	0.039
H	15.67	16.07	0.617	0.633
I	2-Ø1.0 DEEP 0.10		-	
J	5.400		0.212	
K	4.500	4.900	0.177	0.193
L	6.480	0.680	0.255	0.262
M	0.450	0.600	0.017	0.023
N	2.560	2.960	0.100	0.166
O	0.700		0.027	
P	2.340	2.740	0.092	0.107