

LPC2104/2105/2106

Single-chip 32-bit microcontrollers; 128 kB ISP/IAP Flash with 64 kB/32 kB/16 kB RAM

Rev. 04 — 05 February 2004

Product data

1. General description

The LPC2104, 2105 and 2106 are based on a 16/32 bit ARM7TDMI-S CPU with real-time emulation and embedded trace support, together with 128 kbytes (kB) of embedded high speed flash memory. A 128 bit wide memory interface and a unique accelerator architecture enable 32 bit code execution at maximum clock rate. For critical code size applications, the alternative 16-bit Thumb Mode reduces code by more than 30% with minimal performance penalty.

Due to their tiny size and low power consumption, these microcontrollers are ideal for applications where miniaturization is a key requirement, such as access control and point-of-sale. With a wide range of serial communications interfaces and on-chip SRAM options up to 64 kilobytes, they are very well suited for communication gateways and protocol converters, soft modems, voice recognition and low end imaging, providing both large buffer size and high processing power. Various 32 bit timers, PWM channels and 32 GPIO lines make these microcontrollers particularly suitable for industrial control and medical systems.

2. Features

2.1 Key features

- 16/32 bit ARM7TDMI-S processor.
- 16/32/64 kB on-chip Static RAM.
- 128 kB on-chip Flash Program Memory. 128 bit wide interface/accelerator enables high speed 60 MHz operation.
- In-System Programming (ISP) and In-Application Programming (IAP) via on-chip boot-loader software. Flash programming takes 1 ms per 512 byte line. Single sector or full chip erase takes 400 ms.
- Vectored Interrupt Controller with configurable priorities and vector addresses.
- EmbeddedICE-RT interface enables breakpoints and watchpoints. Interrupt service routines can continue to execute whilst the foreground task is debugged with the on-chip RealMonitor software.
- Embedded Trace Macrocell enables non-intrusive high speed real-time tracing of instruction execution.
- Multiple serial interfaces including two UARTs (16C550), Fast I²C (400 kbits/s) and SPI.
- Two 32-bit timers (7 capture/compare channels), PWM unit (6 outputs), Real Time Clock and Watchdog.
- Up to thirty-two 5 V tolerant general purpose I/O pins in a tiny LQFP48 (7 × 7 mm²) package.



PHILIPS

- 60 MHz maximum CPU clock available from programmable on-chip Phase-Locked Loop.
- On-chip crystal oscillator with an operating range of 1 MHz to 30 MHz.
- Two low power modes, Idle and Power-down.
- Processor wake-up from Power-down mode via external interrupt.
- Individual enable/disable of peripheral functions for power optimization.
- Dual power supply:
 - ◆ CPU operating voltage range of 1.65 V to 1.95 V (1.8 V \pm 8.3%).
 - ◆ I/O power supply range of 3.0 V to 3.6 V (3.3 V \pm 10%) with 5 V tolerant I/O pads.

3. Ordering information

Table 1: Ordering information

Type number	Package		
	Name	Description	Version
LPC2104BBD48	LQFP48	plastic low profile quad flat package, 48 leads, body 7 × 7 × 1.4 mm	SOT313-2
LPC2105BBD48	LQFP48	plastic low profile quad flat package, 48 leads, body 7 × 7 × 1.4 mm	SOT313-2
LPC2106BBD48	LQFP48	plastic low profile quad flat package, 48 leads, body 7 × 7 × 1.4 mm	SOT313-2
LPC2106FHN48	HVQFN48	plastic thermal enhanced very thin quad flat package, no leads, 48 terminals, body 7 × 7 × 0.85	SOT619-1

3.1 Ordering options

Table 2: Part options

Type number	Flash memory	RAM	Temperature range
LPC2104BBD48	128 kB	16 kB	0 to +70, LQFP
LPC2105BBD48	128 kB	32 kB	0 to +70, LQFP
LPC2106BBD48	128 kB	64 kB	0 to +70, LQFP
LPC2106FHN48	128 kB	60 kB	-40 to +85, HVQFN

4. Block diagram

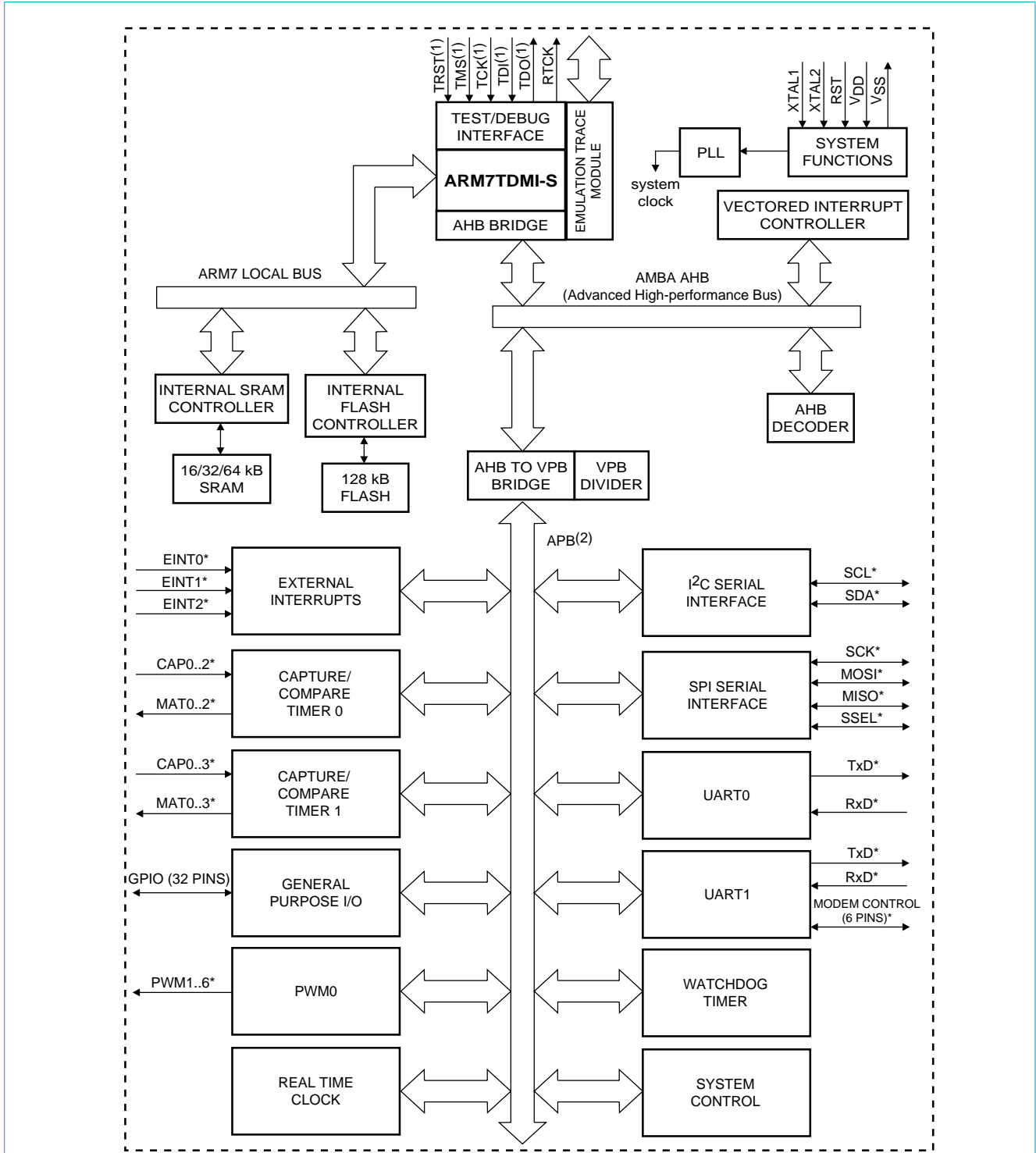

- (1) When test/debug interface is used, GPIO/other function sharing these pins are not available.
- (2) APB with Ready signal.

Fig 1. Block diagram.

5. Pinning information

5.1 Pinning

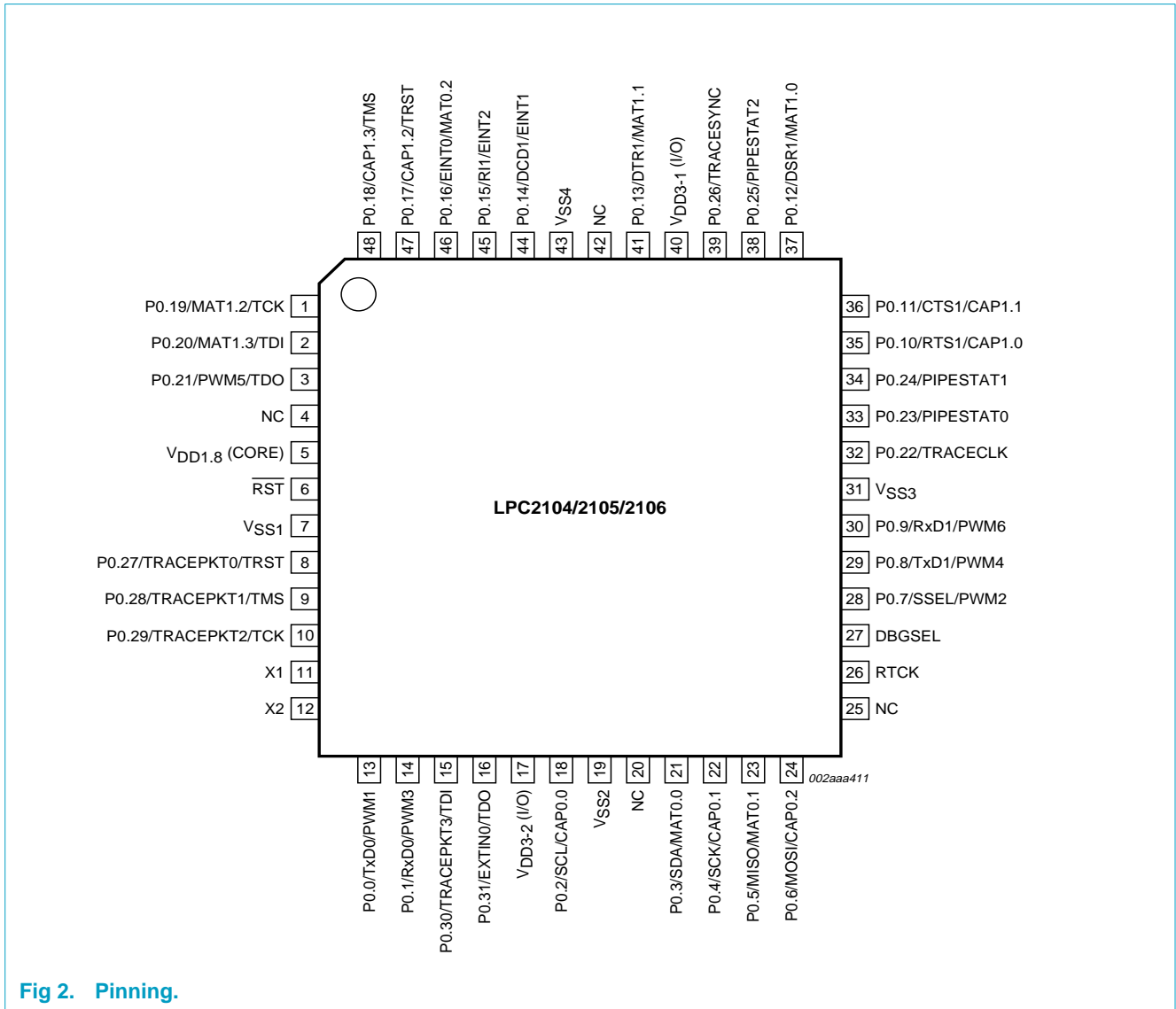

Fig 2. Pinning.

5.2 Pin description

Table 3: Pin description

Symbol	Pin	Type	Description
P0.0 to P0.31	13, 14, 18, 21-24, 28-30, 35-37, 41, 44-48, 1-3, 32-34, 38, 39, 8-10, 15, 16	I/O	Port 0: Port 0 is a 32-bit bi-directional I/O port with individual direction controls for each bit. The operation of port 0 pins depends upon the pin function selected via the Pin Connect Block.
	13	I/O	P0.0 — Port 0 bit 0.
		O	TxD0 — Transmitter output for UART 0.
		O	PWM1 — Pulse Width Modulator output 1.
	14	I/O	P0.1 — Port 0 bit 1.
		I	RxD0 — Receiver input for UART 0.
		O	PWM3 — Pulse Width Modulator output 3.
	18	I/O	P0.2 — Port 0 bit 2.
		I/O	SCL — I ² C clock input/output. Open drain output (for I ² C compliance).
		I	CAP0.0 — Capture input for Timer 0, channel 0.
	21	I/O	P0.3 — Port 0 bit 3.
		I/O	SDA — I ² C data input/output. Open drain output (for I ² C compliance).
		O	MAT0.0 — Match output for Timer 0, channel 0.
	22	I/O	P0.4 — Port 0 bit 4.
		I/O	SCK — Serial clock. SPI clock output from master or input to slave.
		I	CAP0.1 — Capture input for Timer 0, channel 1.
	23	I/O	P0.5 — Port 0 bit 5.
		I/O	MISO — Master In Slave Out. Data input to SPI master or data output from SPI slave.
		O	MAT0.1 — Match output for Timer 0, channel 1.
	24	I/O	P0.6 — Port 0 bit 6.
		I/O	MOSI — Master Out Slave In. Data output from SPI master or data input to SPI slave.
		I	CAP0.2 — Capture input for Timer 0, channel 2.
	28	I/O	P0.7 — Port 0 bit 7.
		I	SSEL — Slave Select. Selects the SPI interface as a slave.
		O	PWM2 — Pulse Width Modulator output 2.
	29	I/O	P0.8 — Port 0 bit 8.
		O	TxD1 — Transmitter output for UART 1.
		O	PWM4 — Pulse Width Modulator output 4.

Table 3: Pin description...continued

Symbol	Pin	Type	Description
	30	I/O	P0.9 — Port 0 bit 9.
		I	RxD1 — Receiver input for UART 1.
		O	PWM6 — Pulse Width Modulator output 6.
	35	I/O	P0.10 — Port 0 bit 10.
		O	RTS1 — Request to Send output for UART 1.
		I	CAP1.0 — Capture input for Timer 1, channel 0.
	36	I/O	P0.11 — Port 0 bit 11.
		I	CTS1 — Clear to Send input for UART 1.
		I	CAP1.1 — Capture input for Timer 1, channel 1.
	37	I/O	P0.12 — Port 0 bit 12.
		I	DSR1 — Data Set Ready input for UART 1.
		O	MAT1.0 — Match output for Timer 1, channel 0.
	41	I/O	P0.13 — Port 0 bit 13.
		O	DTR1 — Data Terminal Ready output for UART 1.
		O	MAT1.1 — Match output for Timer 1, channel 1.
	44	I/O	P0.14 — Port 0 bit 14.
		I	DCD1 — Data Carrier Detect input for UART 1.
		I	EINT1 — External interrupt 1 input.
	45	I/O	P0.15 — Port 0 bit 15.
		I	RI1 — Ring Indicator input for UART 1.
		O	EINT2 — External interrupt 2 input.
	46	I/O	P0.16 — Port 0 bit 16.
		I	EINT0 — External interrupt 0 input.
		O	MAT0.2 — Match output for Timer 0, channel 2.
	47	I/O	P0.17 — Port 0 bit 17.
		I	CAP1.2 — Capture input for Timer 1, channel 2.
		I	TRST — Test Reset for JTAG interface, primary JTAG pin group.
	48	I/O	P0.18 — Port 0 bit 18.
		I	CAP1.3 — Capture input for Timer 1, channel 3.
		I	TMS — Test Mode Select for JTAG interface, primary JTAG pin group.
	1	I/O	P0.19 — Port 0 bit 19.
		O	MAT1.2 — Match output for Timer 1, channel 2.
		I	TCK — Test Clock for JTAG interface, primary JTAG pin group.
	2	I/O	P0.20 — Port 0 bit 20.
		O	MAT1.3 — Match output for Timer 1, channel 3.
		I	TDI — Test Data In for JTAG interface, primary JTAG pin group
	3	I/O	P0.21 — Port 0 bit 21.
		O	PWM5 — Pulse Width Modulator output 5.
		O	TDO — Test Data Out for JTAG interface, primary JTAG pin group.
	32	I/O	P0.22 — Port 0 bit 22.
		O	TRACECLK — Trace Clock. Standard I/O port with internal pull-up.

Table 3: Pin description...continued

Symbol	Pin	Type	Description
	33	I/O	P0.23 — Port 0 bit 23.
		O	PIPESTAT0 — Pipeline Status, bit 0. Standard I/O port with internal pull-up.
	34	I/O	P0.24 — Port 0 bit 24.
		O	PIPESTAT1 — Pipeline Status, bit 1. Standard I/O port with internal pull-up.
	38	I/O	P0.25 — Port 0 bit 25.
		O	PIPESTAT2 — Pipeline Status, bit 2. Standard I/O port with internal pull-up.
	39	I/O	P0.26 — Port 0 bit 26.
		O	TRACESYNC — Trace Synchronization Standard I/O port with internal pull-up.
	8	I/O	P0.27 — Port 0 bit 27.
		O	TRACEPKT0 — Trace Packet, bit 0. Standard I/O port with internal pull-up.
		I	TRST — Test Reset for JTAG interface, secondary JTAG pin group.
	9	I/O	P0.28 — Port 0 bit 28.
		O	TRACEPKT1 — Trace Packet, bit 1. Standard I/O port with internal pull-up.
		I	TMS — Test Mode Select for JTAG interface, secondary JTAG pin group
	10	I/O	P0.29 — Port 0 bit 29.
		O	TRACEPKT2 — Trace Packet, bit 2. Standard I/O port with internal pull-up.
		I	TCK — Test Clock for JTAG interface, secondary JTAG pin group.
	15	I/O	P0.30 — Port 0 bit 30.
		O	TRACEPKT3 — Trace Packet, bit 3. Standard I/O port with internal pull-up.
		I	TDI — Test Data In for JTAG interface, secondary JTAG pin group.
	16	I/O	P0.31 — Port 0 bit 31.
		I	EXTINO — External Trigger Input. Standard I/O port with internal pull-up.
		O	TDO — Test Data out for JTAG interface, secondary JTAG pin group.
RTCK	26	I/O	Returned Test Clock output: Extra signal added to the JTAG port. Assists debugger synchronization when processor frequency varies. Also used during debug mode entry to select primary or secondary JTAG pins with the 48-pin package. Bi-directional pin with internal pull-up.
DBGSEL	27	I	Debug Select: When LOW, the part operates normally. When HIGH, debug mode is entered. Input pin with internal pull-down.
RST	6	I	External Reset input: A LOW on this pin resets the device, causing I/O ports and peripherals to take on their default states, and processor execution to begin at address 0.
X1	11	I	Input to the oscillator circuit and internal clock generator circuits.
X2	12	O	Output from the oscillator amplifier.
V _{SS1} - V _{SS4}	7, 19, 31, 43	I	Ground: 0 V reference.
V _{DD1.8}	5	I	1.8 V Core Power Supply: This is the power supply voltage for internal circuitry.
V _{DD3}	17, 40	I	3.3 V Pad Power Supply: This is the power supply voltage for the I/O ports.
NC	4, 20, 25, 42	-	Not Connected: These pins are not connected in the 48 pin package.

6. Functional description

6.1 Architectural overview

The ARM7TDMI-S is a general purpose 32-bit microprocessor, which offers high performance and very low power consumption. The ARM architecture is based on Reduced Instruction Set Computer (RISC) principles, and the instruction set and related decode mechanism are much simpler than those of microprogrammed Complex Instruction Set Computers. This simplicity results in a high instruction throughput and impressive real-time interrupt response from a small and cost-effective processor core.

Pipeline techniques are employed so that all parts of the processing and memory systems can operate continuously. Typically, while one instruction is being executed, its successor is being decoded, and a third instruction is being fetched from memory.

The ARM7TDMI-S processor also employs a unique architectural strategy known as THUMB, which makes it ideally suited to high-volume applications with memory restrictions, or applications where code density is an issue.

The key idea behind THUMB is that of a super-reduced instruction set. Essentially, the ARM7TDMI-S processor has two instruction sets:

- The standard 32-bit ARM set.
- A 16-bit THUMB set.

The THUMB set's 16-bit instruction length allows it to approach twice the density of standard ARM code while retaining most of the ARM's performance advantage over a traditional 16-bit processor using 16-bit registers. This is possible because THUMB code operates on the same 32-bit register set as ARM code.

THUMB code is able to provide up to 65% of the code size of ARM, and 160% of the performance of an equivalent ARM processor connected to a 16-bit memory system.

6.2 On-Chip Flash program memory

The LPC2104, LPC2105 and LPC2106 incorporate a 128 kB Flash memory system. This memory may be used for both code and data storage. Programming of the Flash memory may be accomplished in several ways. It may be programmed In System via the serial port. The application program may also erase and/or program the Flash while the application is running, allowing a great degree of flexibility for data storage field firmware upgrades, etc. When on-chip bootloader is used, 120 kB of Flash memory is available for user code.

6.3 On-Chip static RAM

On-Chip static RAM may be used for code and/or data storage. The SRAM may be accessed as 8-bits, 16-bits, and 32-bits. The LPC2104 provides a 16 kB static RAM, the LPC2105 provides a 32 kB static RAM, and the LPC2106 provides a 64 kB static RAM.

6.4 Memory map

The LPC2104, LPC2105 and LPC2106 memory maps incorporate several distinct regions, as shown in the following figures.

In addition, the CPU interrupt vectors may be re-mapped to allow them to reside in either Flash memory (the default) or on-chip static RAM. This is described in [Section 6.17 "System control"](#).

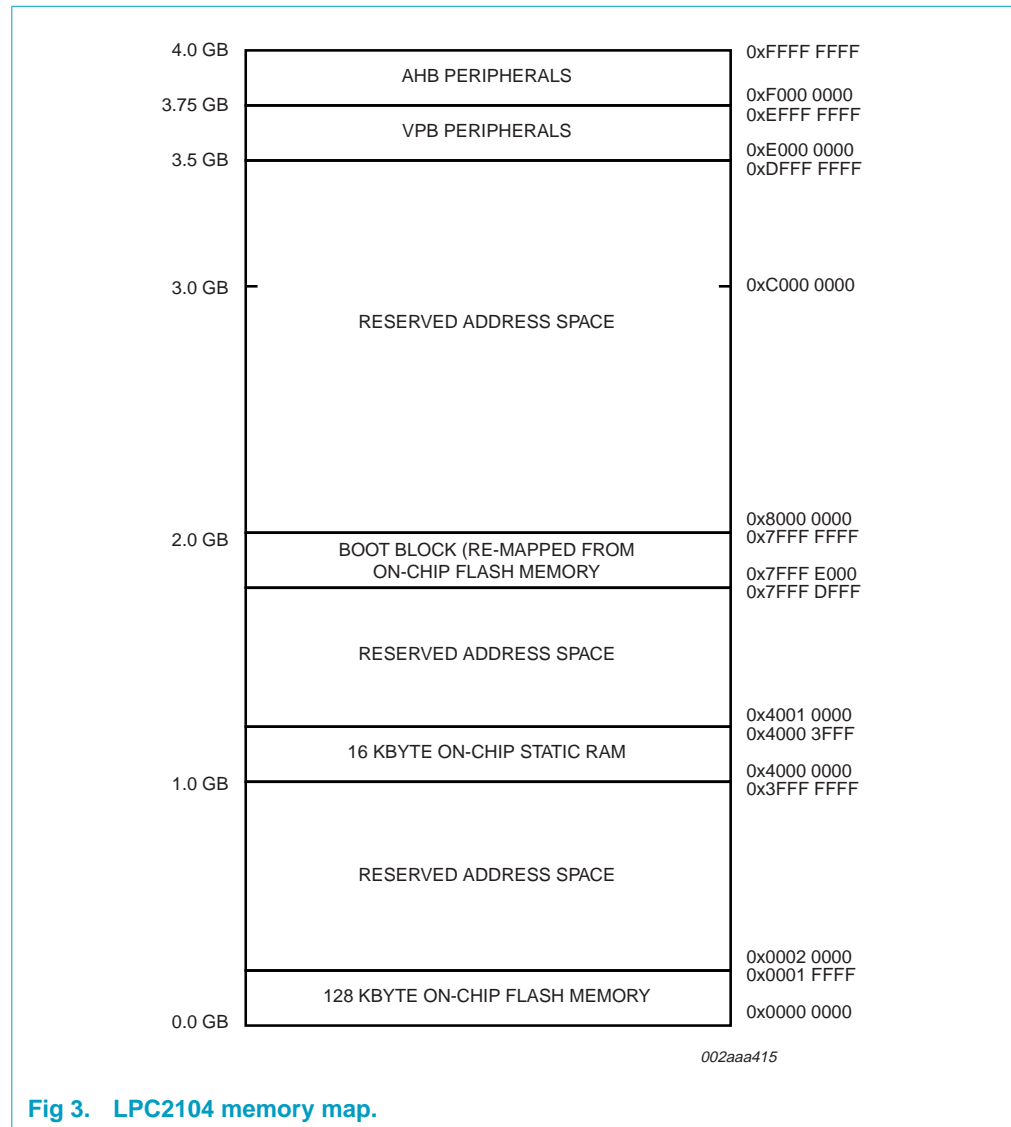

Fig 3. LPC2104 memory map.

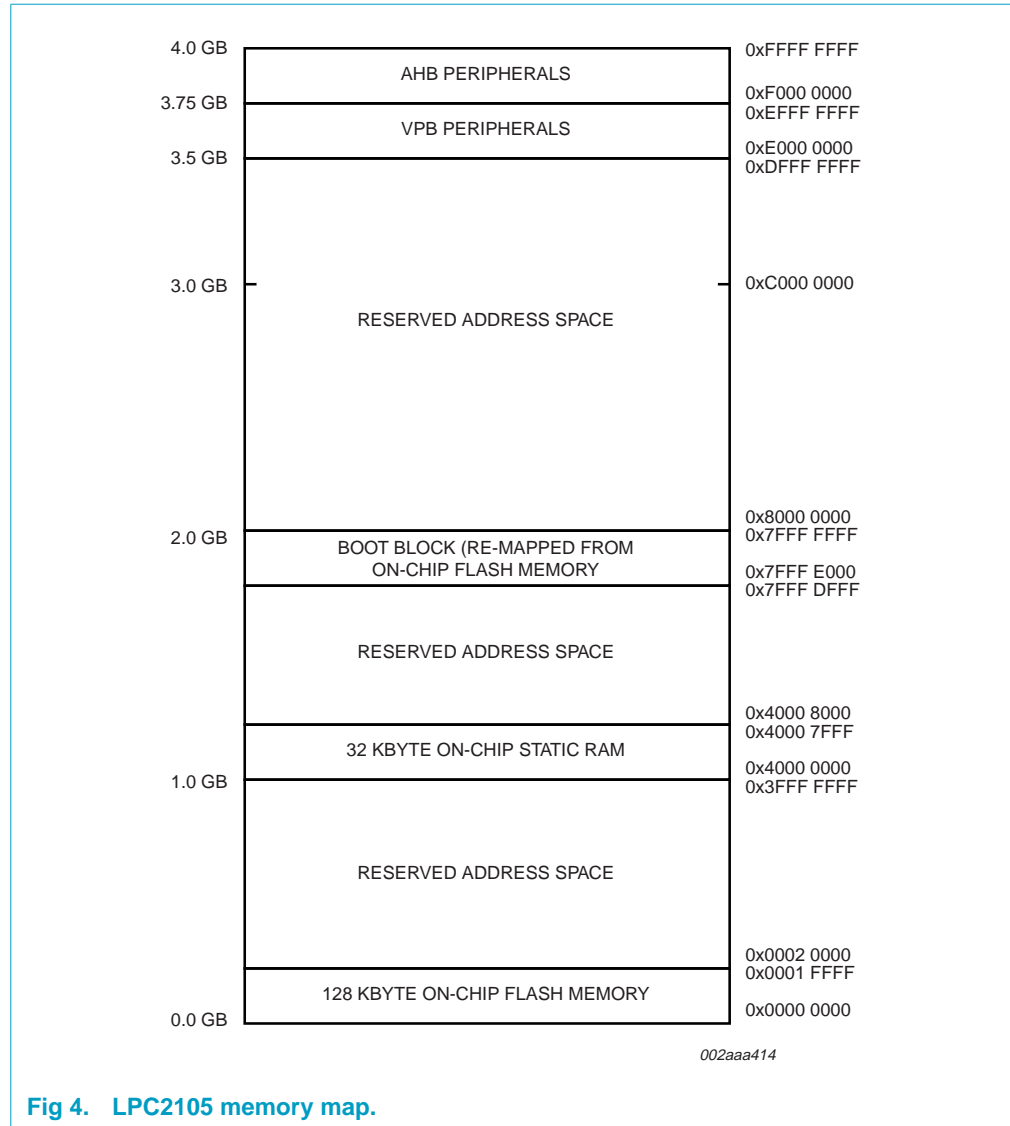

Fig 4. LPC2105 memory map.

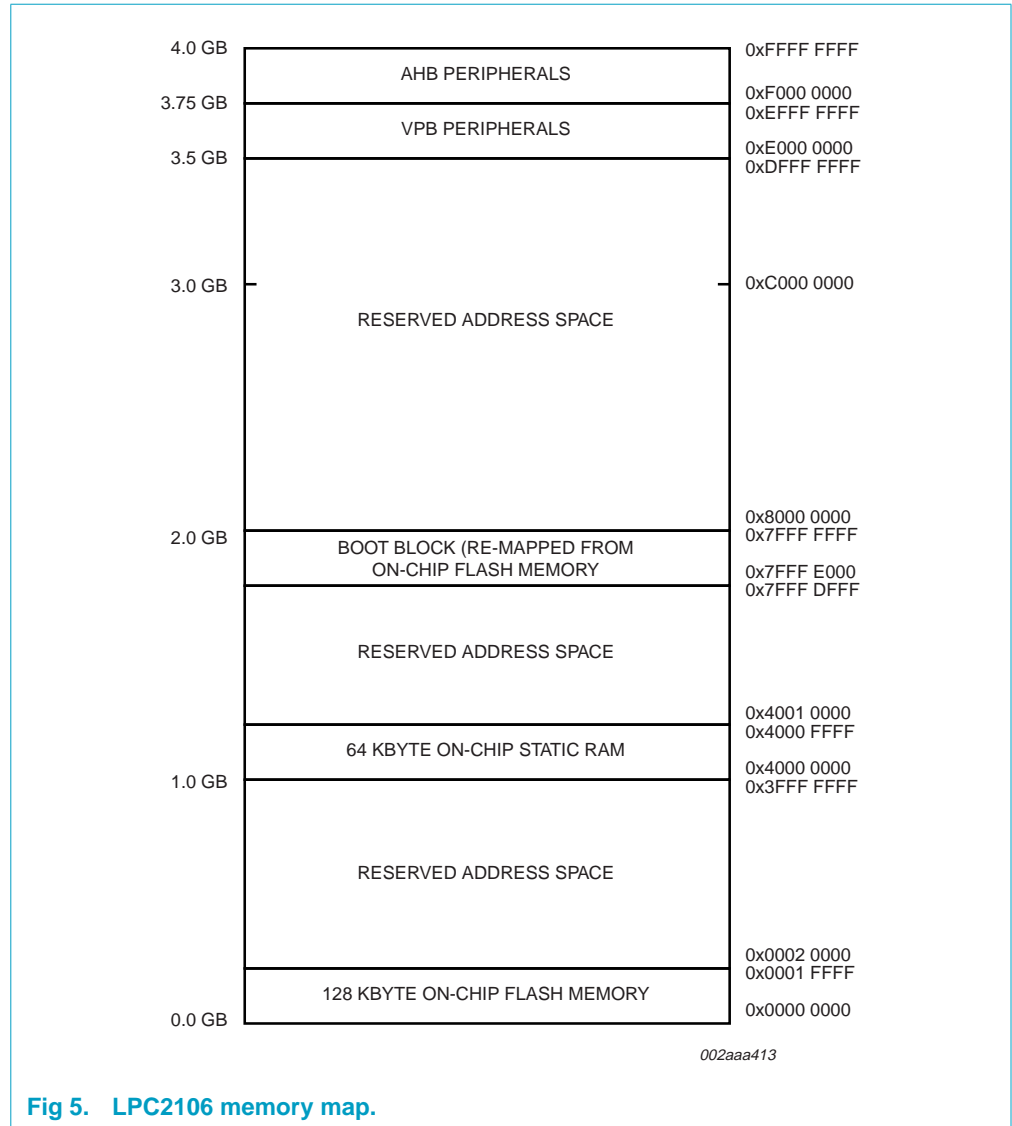

Fig 5. LPC2106 memory map.

6.5 Interrupt controller

The Vectored Interrupt Controller (VIC) accepts all of the interrupt request inputs and categorizes, them as FIQ, vectored IRQ, and non-vectored IRQ as defined by programmable settings. The programmable assignment scheme means that priorities of interrupts from the various peripherals can be dynamically assigned and adjusted.

Fast Interrupt reQuest (FIQ) has the highest priority. If more than one request is assigned to FIQ, the VIC combines the requests to produce the FIQ signal to the ARM processor. The fastest possible FIQ latency is achieved when only one request is classified as FIQ, because then the FIQ service routine can simply start dealing with that device. But if more than one request is assigned to the FIQ class, the FIQ service routine can read a word from the VIC that identifies which FIQ source(s) is (are) requesting an interrupt.

Vectored IRQs have the middle priority. Sixteen of the interrupt requests can be assigned to this category. Any of the interrupt requests can be assigned to any of the 16 vectored IRQ slots, among which slot 0 has the highest priority and slot 15 has the lowest.

Non-vectored IRQs have the lowest priority.

The VIC combines the requests from all the vectored and non-vectored IRQs to produce the IRQ signal to the ARM processor. The IRQ service routine can start by reading a register from the VIC and jumping there. If any of the vectored IRQs are requesting, the VIC provides the address of the highest-priority requesting IRQs service routine, otherwise it provides the address of a default routine that is shared by all the non-vectored IRQs. The default routine can read another VIC register to see what IRQs are active.

6.5.1 Interrupt sources

Table 4 lists the interrupt sources for each peripheral function. Each peripheral device has one interrupt line connected to the Vectored Interrupt Controller, but may have several internal interrupt flags. Individual interrupt flags may also represent more than one interrupt source.

Table 4: Interrupt sources

Block	Flag(s)	VIC channel #
WDT	Watchdog Interrupt (WDINT)	0
-	Reserved for software interrupts only	1
ARM Core	Embedded ICE, DbgCommRx	2
ARM Core	Embedded ICE, DbgCommTx	3
Timer 0	Match 0 - 3 (MR0, MR1, MR2, MR3) Capture 0 - 3 (CR0, CR1, CR2, CR3)	4
Timer 1	Match 0 - 3 (MR0, MR1, MR2, MR3) Capture 0 - 3 (CR0, CR1, CR2, CR3)	5
UART 0	Rx Line Status (RLS) Transmit Holding Register empty (THRE) Rx Data Available (RDA) Character Time-out Indicator (CTI)	6
UART 1	Rx Line Status (RLS) Transmit Holding Register empty (THRE) Rx Data Available (RDA) Character Time-out Indicator (CTI) Modem Status Interrupt (MSI)	7
PWM0	Match 0 - 6 (MR0, MR1, MR2, MR3, MR4, MR5, MR6)	8
I ² C	SI (state change)	9
SPI	SPIF, MODF	10
-	reserved	11
PLL	PLL Lock (PLOCK)	12
RTC	RTCCIF (Counter Increment), RTCALF (Alarm)	13

Table 4: Interrupt sources...continued

Block	Flag(s)	VIC channel #
System Control	External Interrupt 0 (EINT0)	14
System Control	External Interrupt 1 (EINT1)	15
System Control	External Interrupt 2 (EINT2)	16

6.6 Pin connect block

The pin connect block allows selected pins of the microcontroller to have more than one function. Configuration registers control the multiplexers to allow connection between the pin and the on chip peripherals. Peripherals should be connected to the appropriate pins prior to being activated, and prior to any related interrupt(s) being enabled. Activity of any enabled peripheral function that is not mapped to a related pin should be considered undefined.

The Pin Control Module contains two registers as shown in [Table 5](#).

Table 5:

Address	Name	Description	Access
0xE002C000	PINSEL0	Pin function select register 0	Read/Write
0xE002C004	PINSEL1	Pin function select register 1	Read/Write

6.7 Pin function select register 0 (PINSEL0 - 0xE002C000)

The PINSEL0 register controls the functions of the pins as per the settings listed in [Table 6](#). The direction control bit in the IODIR register is effective only when the GPIO function is selected for a pin. For other functions, direction is controlled automatically. Settings other than those shown in [Table 6](#) are reserved, and should not be used

Table 6: Pin function select register 0 (PINSEL0 - 0xE002C000)

PINSEL0	Pin name	Value	Function	Value after Reset
1:0	P0.0	0	GPIO Port 0.0	0
		0	TxD (UART 0)	
		1	PWM1	
3:2	P0.1	0	GPIO Port 0.1	0
		0	RxD (UART 0)	
		1	PWM3	
5:4	P0.2	0	GPIO Port 0.2	0
		0	SCL (I ² C)	
		1	Capture 0.0 (Timer 0)	
7:6	P0.3	0	GPIO Port 0.3	0
		0	SDA (I ² C)	
		1	Match 0.0 (Timer 0)	
9:8	P0.4	0	GPIO Port 0.4	0
		0	SCK (SPI)	
		1	Capture 0.1 (Timer 0)	

Table 6: Pin function select register 0 (PINSELO - 0xE002C000)...*continued*

PINSELO	Pin name	Value		Function	Value after Reset
11:10	P0.5	0	0	GPIO Port 0.5	0
		0	1	MISO (SPI)	
		1	0	Match 0.1 (Timer 0)	
13:12	P0.6	0	0	GPIO Port 0.6	0
		0	1	MOSI (SPI)	
		1	0	Capture 0.2 (Timer 0)	
15:14	P0.7	0	0	GPIO Port 0.7	0
		0	1	SSEL (SPI)	
		1	0	PWM2	
17:16	P0.8	0	0	GPIO Port 0.8	0
		0	1	TxD UART 1	
		1	0	PWM4	
19:18	P0.9	0	0	GPIO Port 0.9	0
		0	1	RxD (UART 1)	
		1	0	PWM6	
21:20	P0.10	0	0	GPIO Port 0.10	0
		0	1	RTS (UART1)	
		1	0	Capture 1.0 (Timer 1)	
23:22	P0.11	0	0	GPIO Port 0.11	0
		0	1	CTS (UART1)	
		1	0	Capture 1.1 (Timer 1)	
25:24	P0.12	0	0	GPIO Port 0.12	0
		0	1	DSR (UART1)	
		1	0	Match 1.0 (Timer 1)	
27:26	P0.13	0	0	GPIO Port 0.13	0
		0	1	DTR (UART 1)	
		1	0	Match 1.1 (Timer 1)	
29:28	P0.14	0	0	GPIO Port 0.14	0
		0	1	CD (UART 1)	
		1	0	EINT1	
31:30	P0.15	0	0	GPIO Port 0.15	0
		0	1	RI (UART1)	
		1	0	EINT2	

6.8 Pin function select register 1 (PINSEL1 - 0xE002C004)

The PINSEL1 register controls the functions of the pins as per the settings listed in [Table 7](#). The direction control bit in the IODIR register is effective only when the GPIO function is selected for a pin. For other functions direction is controlled automatically. Function control for the pins P0.17 - P0.31 is effective only when the DBGSEL input is pulled LOW during RESET.

Table 7: Pin function select register 1 (PINSEL1 - 0xE002C004)

PINSEL1	Pin Name	Value		Function	Value after Reset
1:0	P0.16	0	0	GPIO Port 0.16	0
		0	1	EINT0	
		1	0	Match 0.2 (Timer 0)	
3:2	P0.17	0	0	GPIO Port 0.17	0
		0	1	Capture 1.2 (Timer 1)	
5:4	P0.18	0	0	GPIO Port 0.18	0
		0	1	Capture 1.3 (Timer 1)	
7:6	P0.19	0	0	GPIO Port 0.19	0
		0	1	Match 1.2 (Timer 1)	
9:8	P0.20	0	0	GPIO Port 0.20	0
		0	1	Match 1.3 (Timer 1)	
11:10	P0.21	0	0	GPIO Port 0.21	0
		0	1	PWM5	
13:12	P0.22	0	0	GPIO Port 0.22	0
15:14	P0.23	0	0	GPIO Port 0.23	0
17:16	P0.24	0	0	GPIO Port 0.24	0
19:18	P0.25	0	0	GPIO Port 0.25	0
21:20	P0.26	0	0	GPIO Port 0.26	0
23:22	P0.27	0	0	GPIO Port 0.27	0
		0	1	TRST	
25:24	P0.28	0	0	GPIO Port 0.28	0
		0	1	TMS	
27:26	P0.29	0	0	GPIO Port 0.29	0
		0	1	TCK	
29:28	P0.30	0	0	GPIO Port 0.30	0
		0	1	TDI	
31:30	P0.31	0	0	GPIO Port 0.31	0
		0	1	TDO	

6.9 General purpose parallel I/O

Device pins that are not connected to a specific peripheral function are controlled by the GPIO registers. Pins may be dynamically configured as inputs or outputs. Separate registers allow setting or clearing any number of outputs simultaneously. The value of the output register may be read back, as well as the current state of the port pins.

6.9.1 Features

- Direction control of individual bits.
- Separate control of output set and clear.
- All I/O default to inputs after reset.

6.10 UARTs

The LPC2104, LPC2105 and LPC2106 each contain two UARTs. One UART provides a full modem control handshake interface, the other provides only transmit and receive data lines.

6.10.1 Features

- 16 byte Receive and Transmit FIFOs.
- Register locations conform to '550 industry standard.
- Receiver FIFO trigger points at 1, 4, 8, and 14 bytes
- Built-in baud rate generator.
- Standard modem interface signals included on UART 1.

6.11 I²C serial I/O controller

I²C is a bi-directional bus for inter-IC control using only two wires: a serial clock line (SCL), and a serial data line (SDA). Each device is recognized by a unique address and can operate as either a receiver-only device (e.g. an LCD driver or a transmitter with the capability to both receive and send information (such as memory). Transmitters and/or receivers can operate in either master or slave mode, depending on whether the chip has to initiate a data transfer or is only addressed. I²C is a multi-master bus, it can be controlled by more than one bus master connected to it.

I²C implemented in LPC2104, LPC2105 and LPC2106 supports bit rate up to 400 kbit/s (Fast I²C).

6.11.1 Features

- Standard I²C compliant bus interface.
- Easy to configure as Master, Slave, or Master/Slave.
- Programmable clocks allow versatile rate control.
- Bidirectional data transfer between masters and slaves.
- Multi-master bus (no central master).
- Arbitration between simultaneously transmitting masters without corruption of serial data on the bus.
- Serial clock synchronization allows devices with different bit rates to communicate via one serial bus.
- Serial clock synchronization can be used as a handshake mechanism to suspend and resume serial transfer.
- The I²C bus may be used for test and diagnostic purposes.

6.12 SPI serial I/O controller

The SPI is a full duplex serial interface, designed to be able to handle multiple masters and slaves connected to a given bus. Only a single master and a single slave can communicate on the interface during a given data transfer. During a data transfer the master always sends a byte of data to the slave, and the slave always sends a byte of data to the master.

6.12.1 Features

- Compliant with Serial Peripheral Interface (SPI) specification.
- Synchronous, Serial, Full Duplex, Communication.
- Combined SPI master and slave.
- Maximum data bit rate of one eighth of the input clock rate.

6.13 General purpose timers

The Timer is designed to count cycles of the peripheral clock (PCLK) and optionally generate interrupts or perform other actions at specified timer values, based on four match registers. It also includes four capture inputs to trap the timer value when an input signal transitions, optionally generating an interrupt.

6.13.1 Features

- A 32-bit Timer/Counter with a programmable 32-bit Prescaler.
- Up to four (Timer 1) and three (Timer 0) 32-bit capture channels, that can take a snapshot of the timer value when an input signal transitions. A capture event may also optionally generate an interrupt.
- Four 32-bit match registers that allow:
 - Continuous operation with optional interrupt generation on match.
 - Stop timer on match with optional interrupt generation.
 - Reset timer on match with optional interrupt generation.
- Up to four (Timer 1) and three (Timer 0) external outputs corresponding to match registers, with the following capabilities:
 - Set LOW on match.
 - Set HIGH on match.
 - Toggle on match.
 - Do nothing on match.

6.14 Watchdog timer

The purpose of the Watchdog is to reset the microcontroller within a reasonable amount of time if it enters an erroneous state. When enabled, the Watchdog will generate a system reset if the user program fails to 'feed' (or reload) the Watchdog within a predetermined amount of time.

6.14.1 Features

- Internally resets chip if not periodically reloaded.
- Debug mode.
- Enabled by software but requires a hardware reset or a Watchdog reset/interrupt to be disabled.
- Incorrect/Incomplete feed sequence causes reset/interrupt if enabled.
- Flag to indicate Watchdog reset.
- Programmable 32-bit timer with internal pre-scaler.
- Selectable time period from ($t_{\text{pclk}} \times 256 \times 4$) to ($t_{\text{pclk}} \times 2^{32} \times 4$) in multiples of $t_{\text{pclk}} \times 4$.

6.15 Real time clock

The Real Time Clock (RTC) is designed to provide a set of counters to measure time when normal or idle operating mode is selected. The RTC has been designed to use little power, making it suitable for battery powered systems where the CPU is not running continuously (Idle mode).

6.15.1 Features

- Measures the passage of time to maintain a calendar and clock.
- Ultra Low Power design to support battery powered systems.
- Provides Seconds, Minutes, Hours, Day of Month, Month, Year, Day of Week, and Day of Year.
- Programmable Reference Clock Divider allows adjustment of the RTC to match various crystal frequencies.

6.16 Pulse width modulator

The PWM is based on the standard Timer block and inherits all of its features, although only the PWM function is pinned out on the LPC2104, LPC2105 and LPC2106. The Timer is designed to count cycles of the peripheral clock (PCLK) and optionally generate interrupts or perform other actions when specified timer values occur, based on seven match registers. It also includes four capture inputs to save the timer value when an input signal transitions, and optionally generate an interrupt when those events occur. The PWM function is in addition to these features, and is based on match register events.

The ability to separately control rising and falling edge locations allows the PWM to be used for more applications. For instance, multi-phase motor control typically requires three non-overlapping PWM outputs with individual control of all three pulse widths and positions.

Two match registers can be used to provide a single edge controlled PWM output. One match register (MR0) controls the PWM cycle rate, by resetting the count upon match. The other match register controls the PWM edge position. Additional single

edge controlled PWM outputs require only one match register each, since the repetition rate is the same for all PWM outputs. Multiple single edge controlled PWM outputs will all have a rising edge at the beginning of each PWM cycle, when an MR0 match occurs.

Three match registers can be used to provide a PWM output with both edges controlled. Again, the MR0 match register controls the PWM cycle rate. The other match registers control the two PWM edge positions. Additional double edge controlled PWM outputs require only two match registers each, since the repetition rate is the same for all PWM outputs.

With double edge controlled PWM outputs, specific match registers control the rising and falling edge of the output. This allows both positive going PWM pulses (when the rising edge occurs prior to the falling edge), and negative going PWM pulses (when the falling edge occurs prior to the rising edge).

6.16.1 Features

- Seven match registers allow up to six single edge controlled or three double edge controlled PWM outputs, or a mix of both types.
- The match registers also allow:
 - Continuous operation with optional interrupt generation on match.
 - Stop timer on match with optional interrupt generation.
 - Reset timer on match with optional interrupt generation.
- Supports single edge controlled and/or double edge controlled PWM outputs. Single edge controlled PWM outputs all go HIGH at the beginning of each cycle unless the output is a constant LOW. Double edge controlled PWM outputs can have either edge occur at any position within a cycle. This allows for both positive going and negative going pulses.
- Pulse period and width can be any number of timer counts. This allows complete flexibility in the trade-off between resolution and repetition rate. All PWM outputs will occur at the same repetition rate.
- Double edge controlled PWM outputs can be programmed to be either positive going or negative going pulses.
- Match register updates are synchronized with pulse outputs to prevent generation of erroneous pulses. Software must “release” new match values before they can become effective.
- May be used as a standard timer if the PWM mode is not enabled.
- A 32-bit Timer/Counter with a programmable 32-bit Prescaler.

6.17 System control

6.17.1 Crystal oscillator

The oscillator supports crystals in the range of 1 MHz to 30 MHz. The oscillator output frequency is called FOSC and the ARM processor clock frequency is referred to as cclk for purposes of rate equations, etc. FOSC and cclk are the same value unless the PLL is running and connected. Refer to [Section 6.17.2 “PLL”](#) for additional information.

6.17.2 PLL

The PLL accepts an input clock frequency in the range of 10 MHz to 25 MHz. The input frequency is multiplied up into the range of 10 MHz to 60 MHz with a Current Controlled Oscillator (CCO). The multiplier can be an integer value from 1 to 32 (in practice, the multiplier value cannot be higher than 6 on this family of microcontrollers due to the upper frequency limit of the CPU). The CCO operates in the range of 156 MHz to 320 MHz, so there is an additional divider in the loop to keep the CCO within its frequency range while the PLL is providing the desired output frequency. The output divider may be set to divide by 2, 4, 8, or 16 to produce the output clock. Since the minimum output divider value is 2, it is insured that the PLL output has a 50% duty cycle. The PLL is turned off and bypassed following a chip Reset and may be enabled by software. The program must configure and activate the PLL, wait for the PLL to Lock, then connect to the PLL as a clock source.

6.17.3 Reset and wake-up timer

Reset has two sources on the LPC2104, LPC2105 and LPC2106: the $\overline{\text{RST}}$ pin and Watchdog Reset. The $\overline{\text{RST}}$ pin is a Schmitt trigger input pin with an additional glitch filter. Assertion of chip Reset by any source starts the Wake-up Timer (see Wake-up Timer description below), causing the internal chip reset to remain asserted until the external Reset is de-asserted, the oscillator is running, a fixed number of clocks have passed, and the on-chip Flash controller has completed its initialization.

When the internal Reset is removed, the processor begins executing at address 0, which is the Reset vector. At that point, all of the processor and peripheral registers have been initialized to predetermined values.

The wake-up timer ensures that the oscillator and other analog functions required for chip operation are fully functional before the processor is allowed to execute instructions. This is important at power on, all types of Reset, and whenever any of the aforementioned functions are turned off for any reason. Since the oscillator and other functions are turned off during Power-down mode, any wake-up of the processor from Power-down mode makes use of the Wake-up Timer.

The Wake-up Timer monitors the crystal oscillator as the means of checking whether it is safe to begin code execution. When power is applied to the chip, or some event caused the chip to exit Power-down mode, some time is required for the oscillator to produce a signal of sufficient amplitude to drive the clock logic. The amount of time depends on many factors, including the rate of V_{DD} ramp (in the case of power on), the type of crystal and its electrical characteristics (if a quartz crystal is used), as well as any other external circuitry (e.g. capacitors), and the characteristics of the oscillator itself under the existing ambient conditions.

6.17.4 External interrupt inputs

The LPC2104, LPC2105 and LPC2106 include three External Interrupt Inputs as selectable pin functions. The External Interrupt Inputs can optionally be used to wake up the processor from Power-down mode.

6.17.5 Memory Mapping Control

The Memory Mapping Control alters the mapping of the interrupt vectors that appear beginning at address 0x00000000. Vectors may be mapped to the bottom of the on-chip Flash memory, or to the on-chip static RAM. This allows code running in different memory spaces to have control of the interrupts.

6.17.6 Power Control

The LPC2104, LPC2105 and LPC2106 support two reduced power modes: Idle mode and Power-down mode. In Idle mode, execution of instructions is suspended until either a Reset or interrupt occurs. Peripheral functions continue operation during Idle mode and may generate interrupts to cause the processor to resume execution. Idle mode eliminates power used by the processor itself, memory systems and related controllers, and internal buses.

In Power-down mode, the oscillator is shut down and the chip receives no internal clocks. The processor state and registers, peripheral registers, and internal SRAM values are preserved throughout Power-down mode and the logic levels of chip output pins remain static. The Power-down mode can be terminated and normal operation resumed by either a Reset or certain specific interrupts that are able to function without clocks. Since all dynamic operation of the chip is suspended, Power-down mode reduces chip power consumption to nearly zero.

A Power Control for Peripherals feature allows individual peripherals to be turned off if they are not needed in the application, resulting in additional power savings.

6.17.7 VPB bus

The VPB Divider determines the relationship between the processor clock (cclk) and the clock used by peripheral devices (PCLK). The VPB Divider serves two purposes. The first is that the VPB bus cannot operate at the highest speeds of the CPU. In order to compensate for this, the VPB bus may be slowed down to one half or one fourth of the processor clock rate. The default condition at reset is for the VPB bus to run at one quarter of the CPU clock. The second purpose of the VPB Divider is to allow power savings when an application does not require any peripherals to run at the full processor rate. Because the VPB Divider is connected to the PLL output, the PLL remains active (if it was running) during Idle mode.

6.18 Emulation and debugging

The LPC2104, LPC2105 and LPC2106 support emulation and debugging via a JTAG serial port. A trace port allows tracing program execution. Each of these functions requires a trade-off of debugging features versus device pins. Because the LPC2104, LPC2105 and LPC2106 are provided in a small package, there is no room for permanently assigned JTAG or Trace pins. An alternate JTAG port allows an option to debug functions assigned to the pins used by the primary JTAG port.

6.18.1 Embedded ICE

Standard ARM EmbeddedICE logic provides on-chip debug support. The debugging of the target system requires a host computer running the debugger software and an EmbeddedICE protocol convertor. EmbeddedICE protocol convertor converts the Remote Debug Protocol commands to the JTAG data needed to access the ARM core.

The ARM core has a Debug Communication Channel function in-built. The debug communication channel allows a program running on the target to communicate with the host debugger or another separate host without stopping the program flow or even entering the debug state. The debug communication channel is accessed as a co-processor 14 by the program running on the ARM7TDMI-S core. The debug communication channel allows the JTAG port to be used for sending and receiving data without affecting the normal program flow. The debug communication channel data and control registers are mapped in to addresses in the EmbeddedICE logic.

6.18.2 Embedded trace

Since the LPC2104, LPC2105 and LPC2106 have significant amounts of on-chip memory, it is not possible to determine how the processor core is operating simply by observing the external pins. The Embedded Trace Macrocell provides real-time trace capability for deeply embedded processor cores. It outputs information about processor execution to the trace port.

The ETM is connected directly to the ARM core and not to the main AMBA system bus. It compresses the trace information and exports it through a narrow trace port. An external trace port analyzer must capture the trace information under software debugger control. Instruction trace (or PC trace) shows the flow of execution of the processor and provides a list of all the instructions that were executed. Instruction trace is significantly compressed by only broadcasting branch addresses as well as a set of status signals that indicate the pipeline status on a cycle by cycle basis. Trace information generation can be controlled by selecting the trigger resource. Trigger resources include address comparators, counters and sequencers. Since trace information is compressed the software debugger requires a static image of the code being executed. Self-modifying code can not be traced because of this restriction.

6.18.3 RealMonitor™

RealMonitor is a configurable software module, developed by ARM Inc., which enables real time debug. It is a lightweight debug monitor that runs in the background while users debug their foreground application. It communicates with the host using the DCC (Debug Communications Channel), which is present in the EmbeddedICE logic. The LPC2104, LPC2105 and LPC2106 contain a specific configuration of RealMonitor software programmed into the on-chip Flash memory.

7. Limiting values

Table 8: Limiting values

In accordance with the Absolute Maximum Rating System (IEC 60134).

Symbol	Parameter	Conditions	Min	Max	Unit
$V_{DD1.8}$	Supply voltage, internal rail		-0.5	+2.5	V
V_{DD3}	Supply voltage, external rail		-0.5	+3.6	V
V_i	DC input voltage, 5 V tolerant I/O pins ^{[3][4]}		-0.5	6.0	V
V_i	DC input voltage, other I/O pins ^{[2][3]}		-0.5	$V_{DD3} + 0.5$	V
I	DC supply current per supply pin ^[5]		-	100	mA
I	DC ground current per ground pin ^[5]		-	100	mA
T_{stg}	Storage temperature ^[6]		-40	125	°C
P	Power dissipation (based on package heat transfer, not device power consumption)		1.5	-	W

[1] The following applies to the Limiting values:

- a) Stresses above those listed under Limiting values may cause permanent damage to the device. This is a stress rating only and functional operation of the device at these or any conditions other than those described in [Section 8 "Static characteristics"](#) and [Section 9 "Dynamic characteristics"](#) of this specification is not implied.
- b) This product includes circuitry specifically designed for the protection of its internal devices from the damaging effects of excessive static charge. Nonetheless, it is suggested that conventional precautions be taken to avoid applying greater than the rated maximum.
- c) Parameters are valid over operating temperature range unless otherwise specified. All voltages are with respect to V_{SS} unless otherwise noted.

[2] Not to exceed 4.6 V.

[3] Including voltage on outputs in 3-state mode.

[4] Only valid when the V_{DD3} supply voltage is present.

[5] The peak current is limited to 25 times the corresponding maximum current.

[6] Dependent on package type.

8. Static characteristics

Table 9: Static characteristics

$T_{amb} = 0\text{ }^{\circ}\text{C}$ to $+70\text{ }^{\circ}\text{C}$ for commercial, unless otherwise specified.

Symbol	Parameter	Conditions	Min	Typ ^[1]	Max	Unit
$V_{DD1.8}$	Supply voltage		1.65	1.8	1.95	V
V_{DD3}	External rail supply voltage		3.0	3.3	3.6	V
Standard Port pins, RST, RTCK, and DBGSEL						
I_{IL}	LOW level input current, no pull-up	$V_i = 0$	-	-	3	μA
I_{IH}	HIGH level input current, no pull down	$V_i = V_{DD3}$	-	-	3	μA
I_{OZ}	3-state output leakage, no pull-up/down	$V_o = 0, V_o = V_{DD3}$	-	-	3	μA
$I_{latchup}$	I/O latch-up current	$-(0.5 V_{DD3}) < V < (1.5 V_{DD3})$ $T_j < 125\text{ }^{\circ}\text{C}$	100	-	-	mA
V_i	Input voltage ^{[3][4][5]}		0	-	5.5	V
V_o	Output voltage, output active		0	-	V_{DD3}	V
V_{IH}	HIGH level input voltage		2.0	-	-	V
V_{IL}	LOW level input voltage		-	-	0.8	V
V_{hys}	Hysteresis voltage		-	0.4	-	V
V_{OH}	HIGH level output voltage ^[6]	$I_{OH} = -4\text{ mA}$	$V_{DD3} - 0.4$	-	-	V
V_{OL}	LOW level output voltage ^[6]	$I_{OL} = -4\text{ mA}$	-	-	0.4	V
I_{OH}	HIGH level output current ^[6]	$V_{OH} = V_{DD3} - 0.4\text{ V}$	-4	-	-	mA
I_{OL}	LOW level output current ^[6]	$V_{OL} = 0.4\text{ V}$	4	-	-	mA
I_{OH}	HIGH level short circuit current ^[7]	$V_{OH} = 0$	-	-	-45	mA
I_{OL}	LOW level short circuit current ^[7]	$V_{OL} = V_{DD3}$	-	-	50	mA
I_{PD}	Pull-down current (applies to DBGSEL)	$V_i = 5\text{ V}$ ^[8]	20	50	100	μA
I_{PU}	Pull-up current (applies to P0.22 - P0.31)	$V_i = 0$	-25	-50	-65	μA
		$V_{DD3} < V_i < 5\text{ V}$ ^[8]	0	0	0	μA
$I_{DD1.8}$	Active Mode	$V_{DD1.8} = 1.8\text{ V}$, cclk = 60 MHz, $T_{amb} = 25\text{ }^{\circ}\text{C}$, code while(1){}	-	30	-	mA
		executed from FLASH, no active peripherals				
		Power-down Mode	$V_{DD1.8} = 1.8\text{ V}$, $T_{amb} = +25\text{ }^{\circ}\text{C}$,	-	10	-
		$V_{DD1.8} = 1.8\text{ V}$, $T_{amb} = +85\text{ }^{\circ}\text{C}$	-	50	500	μA
I²C pins						
V_{IH}	HIGH level input voltage	V_{TOL} is from 4.5 V to 5.5 V	$0.7 V_{TOL}$	-	-	V
V_{IL}	LOW level input voltage	V_{TOL} is from 4.5 V to 5.5 V	-	-	$0.3 V_{TOL}$	V
V_{hys}	Hysteresis voltage	V_{TOL} is from 4.5 V to 5.5 V	-	$0.5 V_{TOL}$	-	V
V_{OL}	LOW level output voltage ^[6]	$I_{OL} = 3\text{ mA}$	-	-	0.4	V

Table 9: Static characteristics...continued $T_{amb} = 0\text{ }^{\circ}\text{C}$ to $+70\text{ }^{\circ}\text{C}$ for commercial, unless otherwise specified.

Symbol	Parameter	Conditions	Min	Typ ^[1]	Max	Unit
I_{lkg}	Input leakage to V_{SS}	$V_i = V_{DD3}$	-	2	4	μA
		$V_i = 5\text{ V}$	-	10	22	μA
Oscillator pins						
	X1 input Voltages		0	-	$V_{DD1.8}$	
	X2 output Voltages		0	-	$V_{DD1.8}$	

[1] Typical ratings are not guaranteed. The values listed are at room temperature ($+25\text{ }^{\circ}\text{C}$), nominal supply voltages.

[2] Pin capacitance is characterized but not tested.

[3] Including voltage on outputs in 3-state mode.

[4] V_{DD3} supply voltages must be present.

[5] 3-state outputs go into 3-state mode when V_{DD3} is grounded.

[6] Accounts for 100 mV voltage drop in all supply lines.

[7] Only allowed for a short time period.

[8] Minimum condition for $V_i = 4.5\text{ V}$, maximum condition for $V_i = 5.5\text{ V}$.

9. Dynamic characteristics

Table 10: Characteristics

$T_{amb} = 0\text{ }^{\circ}\text{C}$ to $+70\text{ }^{\circ}\text{C}$ for commercial, $-40\text{ }^{\circ}\text{C}$ to $+85\text{ }^{\circ}\text{C}$ for industrial, $V_{DD1,8}$, V_{DD3} over specified ranges^[1]

Symbol	Parameter	Conditions	Min	Typ ^[1]	Max	Unit
External Clock						
f_{osc}	Oscillator frequency supplied by an external oscillator (signal generator)		1	-	50	MHz
	External clock frequency supplied by an external crystal oscillator		1	-	30	MHz
	External clock frequency if on-chip PLL is used		10	-	25	MHz
	External clock frequency if ISP is used for initial code download		10	-	25	MHz
t_c	External oscillator clock period		20	-	1000	ns
t_{CHCX}	Clock HIGH time		$t_c \times 0.4$	-	-	ns
t_{CLCX}	Clock LOW time		$t_c \times 0.4$	-	-	ns
t_{CLCH}	Clock rise time		-	-	5	ns
t_{CHCL}	Clock fall time		-	-	5	ns
Port Pins						
t_{RISE}	Port output rise time (except P0.2, P0.3)		-	-	-	ns
t_{FALL}	Port output fall time (except P0.2, P0.3)		-	-	-	ns
I²C pins						
t_f	Output fall time from V_{IH} to V_{IL}		20 + $0.1 \times C_b$ ^[2]	-	-	ns

[1] Parameters are valid over operating temperature range unless otherwise specified.

[2] Bus capacitance C_b in pF, from 10 pF to 400 pF.

9.1 Timing

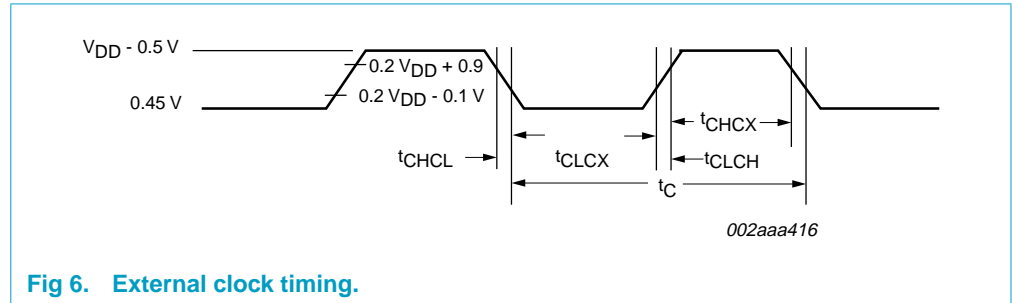

Fig 6. External clock timing.

10. Package outline

LQFP48: plastic low profile quad flat package; 48 leads; body 7 x 7 x 1.4 mm

SOT313-2

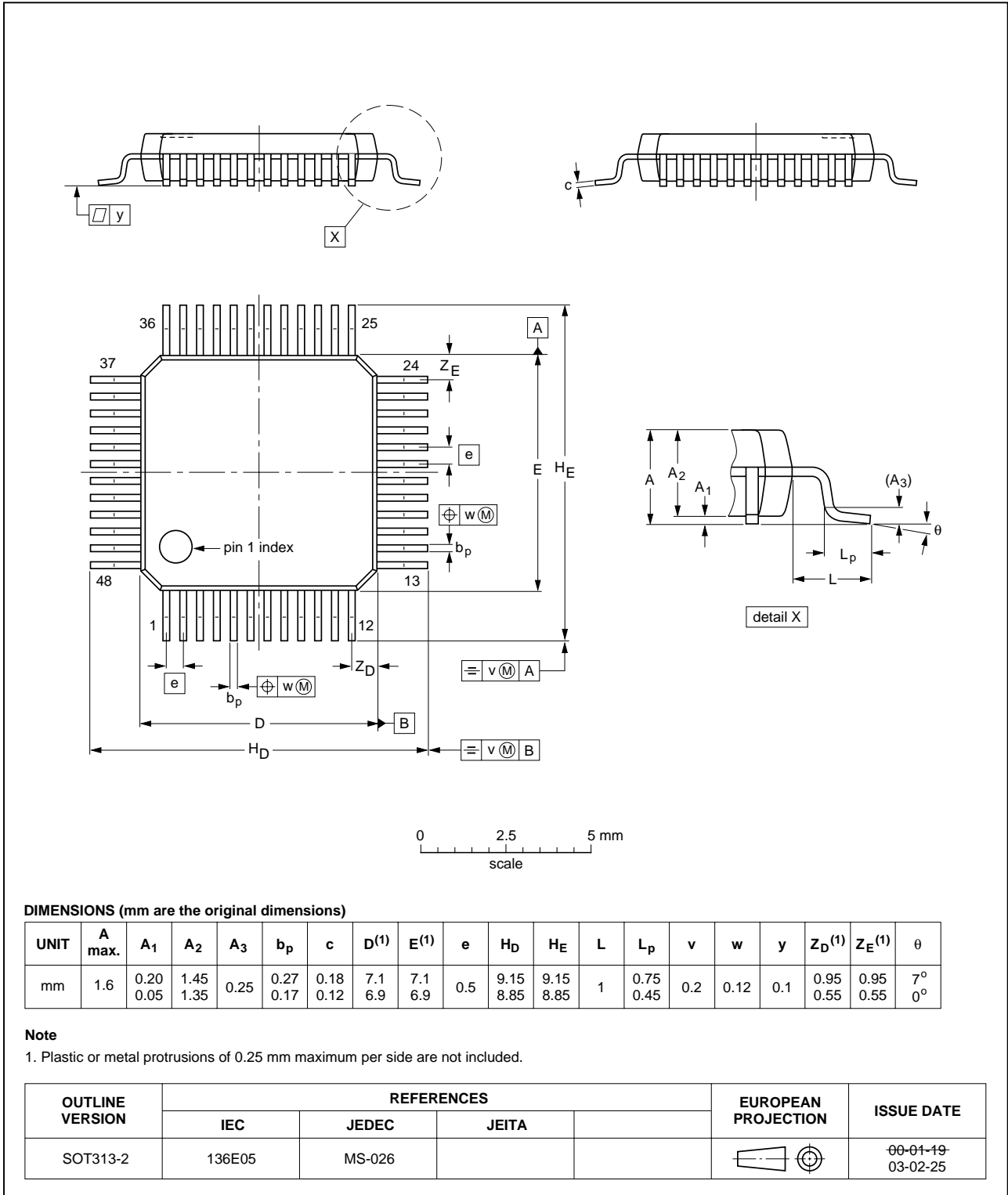

Fig 7. SOT313-2

HVQFN48: plastic thermal enhanced very thin quad flat package; no leads;
48 terminals; body 7 x 7 x 0.85 mm

SOT619-1

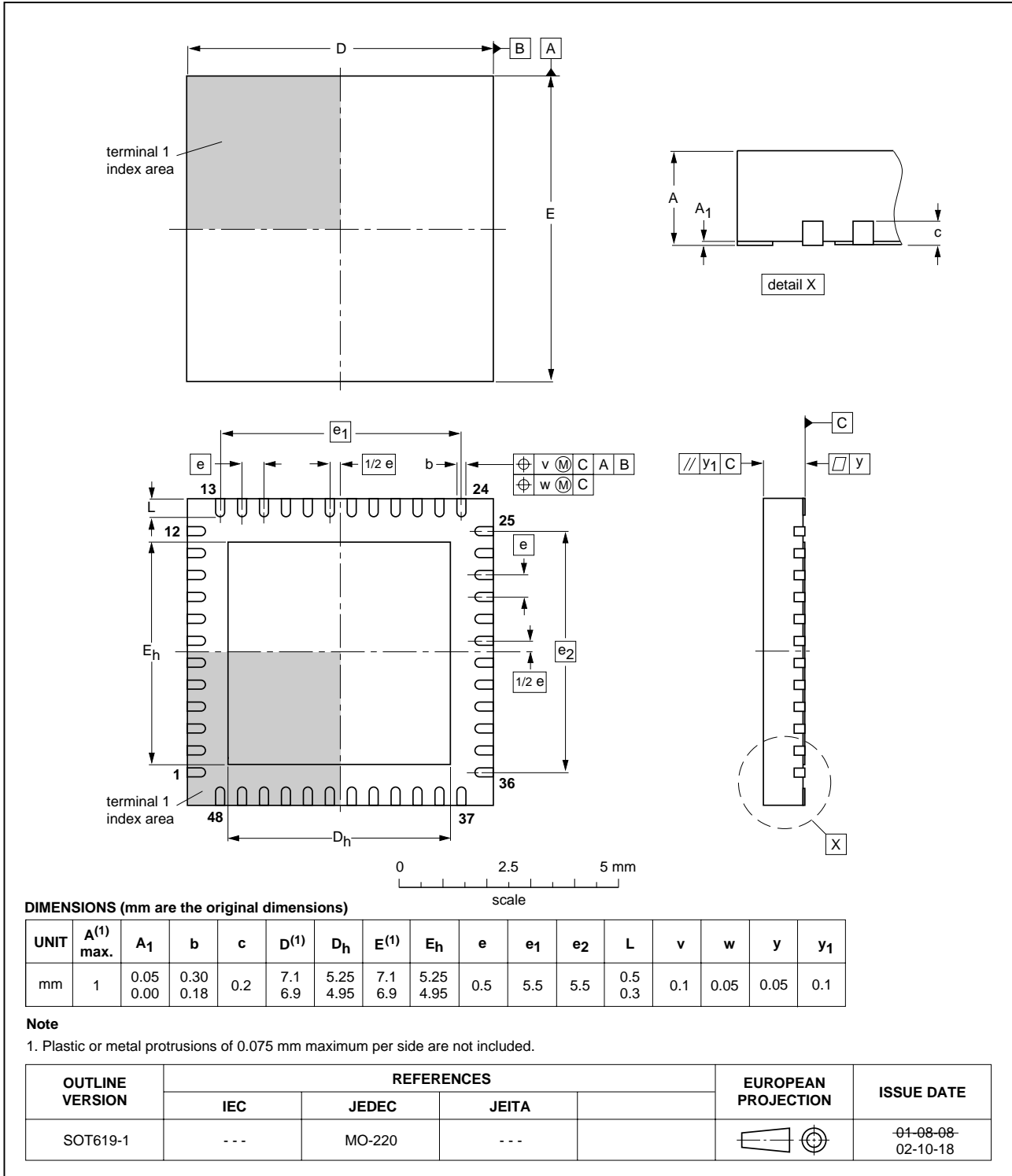

Fig 8. SOT619-1

11. Revision history

Table 11: Revision history

Rev	Date	CPCN	Description
04	20040205	-	Product data (9397 750 12792); 853-2425 ECN 01-A15458f of 28 January 2004 Modifications: <ul style="list-style-type: none">• Table 4 “Interrupt sources” on page 12; removed line in PWM.• Table 10 “Characteristics” on page 26; adjusted values for f_{OSC} and t_C.• Added HVQFN48 package.• On-chip crystal oscillator operating range changed from “10 MHz to 25 MHz” to “1 MHz to 30 MHz”
03	20031007	-	Product data (9397 750 12142); ECN 853-2425 30389 of 30 September 2003
02	20030611	-	Product data (9397 750 11499); ECN 853-2425 29919 of 09 May 2003
01	20030425	-	Product data (9397 750 11414); ECN 853-2425 29855 of 22 April 2003

12. Data sheet status

Level	Data sheet status ^[1]	Product status ^{[2][3]}	Definition
I	Objective data	Development	This data sheet contains data from the objective specification for product development. Philips Semiconductors reserves the right to change the specification in any manner without notice.
II	Preliminary data	Qualification	This data sheet contains data from the preliminary specification. Supplementary data will be published at a later date. Philips Semiconductors reserves the right to change the specification without notice, in order to improve the design and supply the best possible product.
III	Product data	Production	This data sheet contains data from the product specification. Philips Semiconductors reserves the right to make changes at any time in order to improve the design, manufacturing and supply. Relevant changes will be communicated via a Customer Product/Process Change Notification (CPCN).

[1] Please consult the most recently issued data sheet before initiating or completing a design.

[2] The product status of the device(s) described in this data sheet may have changed since this data sheet was published. The latest information is available on the Internet at URL <http://www.semiconductors.philips.com>.

[3] For data sheets describing multiple type numbers, the highest-level product status determines the data sheet status.

13. Definitions

Short-form specification — The data in a short-form specification is extracted from a full data sheet with the same type number and title. For detailed information see the relevant data sheet or data handbook.

Limiting values definition — Limiting values given are in accordance with the Absolute Maximum Rating System (IEC 60134). Stress above one or more of the limiting values may cause permanent damage to the device. These are stress ratings only and operation of the device at these or at any other conditions above those given in the Characteristics sections of the specification is not implied. Exposure to limiting values for extended periods may affect device reliability.

Application information — Applications that are described herein for any of these products are for illustrative purposes only. Philips Semiconductors make no representation or warranty that such applications will be suitable for the specified use without further testing or modification.

14. Disclaimers

Life support — These products are not designed for use in life support appliances, devices, or systems where malfunction of these products can reasonably be expected to result in personal injury. Philips Semiconductors customers using or selling these products for use in such applications do so at their own risk and agree to fully indemnify Philips Semiconductors for any damages resulting from such application.

Right to make changes — Philips Semiconductors reserves the right to make changes in the products - including circuits, standard cells, and/or software - described or contained herein in order to improve design and/or performance. When the product is in full production (status 'Production'), relevant changes will be communicated via a Customer Product/Process Change Notification (CPCN). Philips Semiconductors assumes no responsibility or liability for the use of any of these products, conveys no licence or title under any patent, copyright, or mask work right to these products, and makes no representations or warranties that these products are free from patent, copyright, or mask work right infringement, unless otherwise specified.

15. Licenses

Purchase of Philips I²C components



Purchase of Philips I²C components conveys a license under the Philips' I²C patent to use the components in the I²C system provided the system conforms to the I²C specification defined by Philips. This specification can be ordered using the code 9398 393 40011.

16. Trademarks

RealMonitor — is a trademark of ARM, Inc.

Contact information

For additional information, please visit <http://www.semiconductors.philips.com>.

For sales office addresses, send e-mail to: sales.addresses@www.semiconductors.philips.com.

Fax: +31 40 27 24825

Contents

1	General description	1	7	Limiting values	23
2	Features	1	8	Static characteristics	24
2.1	Key features	1	9	Dynamic characteristics	26
3	Ordering information	2	9.1	Timing	27
3.1	Ordering options	2	10	Package outline	28
4	Block diagram	3	11	Revision history	30
5	Pinning information	4	12	Data sheet status	31
5.1	Pinning	4	13	Definitions	31
5.2	Pin description	5	14	Disclaimers	31
6	Functional description	8	15	Licenses	31
6.1	Architectural overview	8	16	Trademarks	31
6.2	On-Chip Flash program memory	8			
6.3	On-Chip static RAM	8			
6.4	Memory map	9			
6.5	Interrupt controller	11			
6.5.1	Interrupt sources	12			
6.6	Pin connect block	13			
6.7	Pin function select register 0 (PINSEL0 - 0xE002C000)	13			
6.8	Pin function select register 1 (PINSEL1 - 0xE002C004)	14			
6.9	General purpose parallel I/O	15			
6.9.1	Features	15			
6.10	UARTs	16			
6.10.1	Features	16			
6.11	I ² C serial I/O controller	16			
6.11.1	Features	16			
6.12	SPI serial I/O controller	17			
6.12.1	Features	17			
6.13	General purpose timers	17			
6.13.1	Features	17			
6.14	Watchdog timer	17			
6.14.1	Features	18			
6.15	Real time clock	18			
6.15.1	Features	18			
6.16	Pulse width modulator	18			
6.16.1	Features	19			
6.17	System control	20			
6.17.1	Crystal oscillator	20			
6.17.2	PLL	20			
6.17.3	Reset and wake-up timer	20			
6.17.4	External interrupt inputs	21			
6.17.5	Memory Mapping Control	21			
6.17.6	Power Control	21			
6.17.7	VPB bus	21			
6.18	Emulation and debugging	21			
6.18.1	Embedded ICE	22			
6.18.2	Embedded trace	22			
6.18.3	RealMonitor™	22			

© Koninklijke Philips Electronics N.V. 2004.
Printed in the U.S.A.

All rights are reserved. Reproduction in whole or in part is prohibited without the prior written consent of the copyright owner.

The information presented in this document does not form part of any quotation or contract, is believed to be accurate and reliable and may be changed without notice. No liability will be accepted by the publisher for any consequence of its use. Publication thereof does not convey nor imply any license under patent- or other industrial or intellectual property rights.

Date of release: 05 February 2004

Document order number: 9397 750 12792



PHILIPS

Let's make things better.