

LM3089 FM Receiver IF System

General Description

The LM3089 has been designed to provide all the major functions required for modern FM IF designs of automotive, high-fidelity and communications receivers.

Features

- Three stage IF amplifier/limiter provides 12 μV (typ) -3 dB limiting sensitivity
- Balanced product detector and audio amplifier provide 400 mV (typ) of recovered audio with distortion as low as 0.1% with proper external coil designs.
- Four internal carrier level detectors provide delayed AGC signal to tuner, IF level meter drive current and interchannel mute control
- AFC amplifier provides AFC current for tuner and/or center tuning meters
- Improved operating and temperature performance, especially when using high Q quadrature coils in narrow band FM communications receivers
- No mute circuit latchup problems
- A direct replacement for CA3089E

Connection Diagram

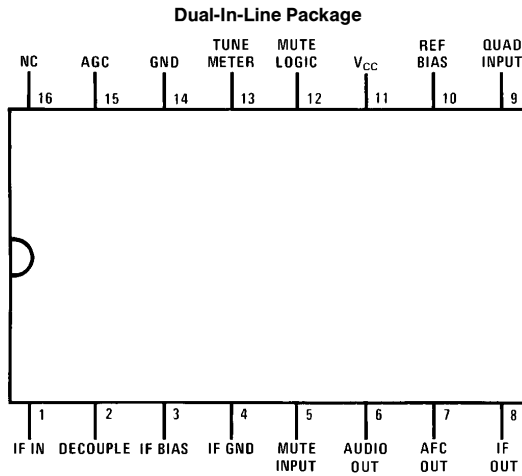

TL/H/7149-2

Top View

Order Number LM3089N
See NS Package Number N16E

Block Diagram

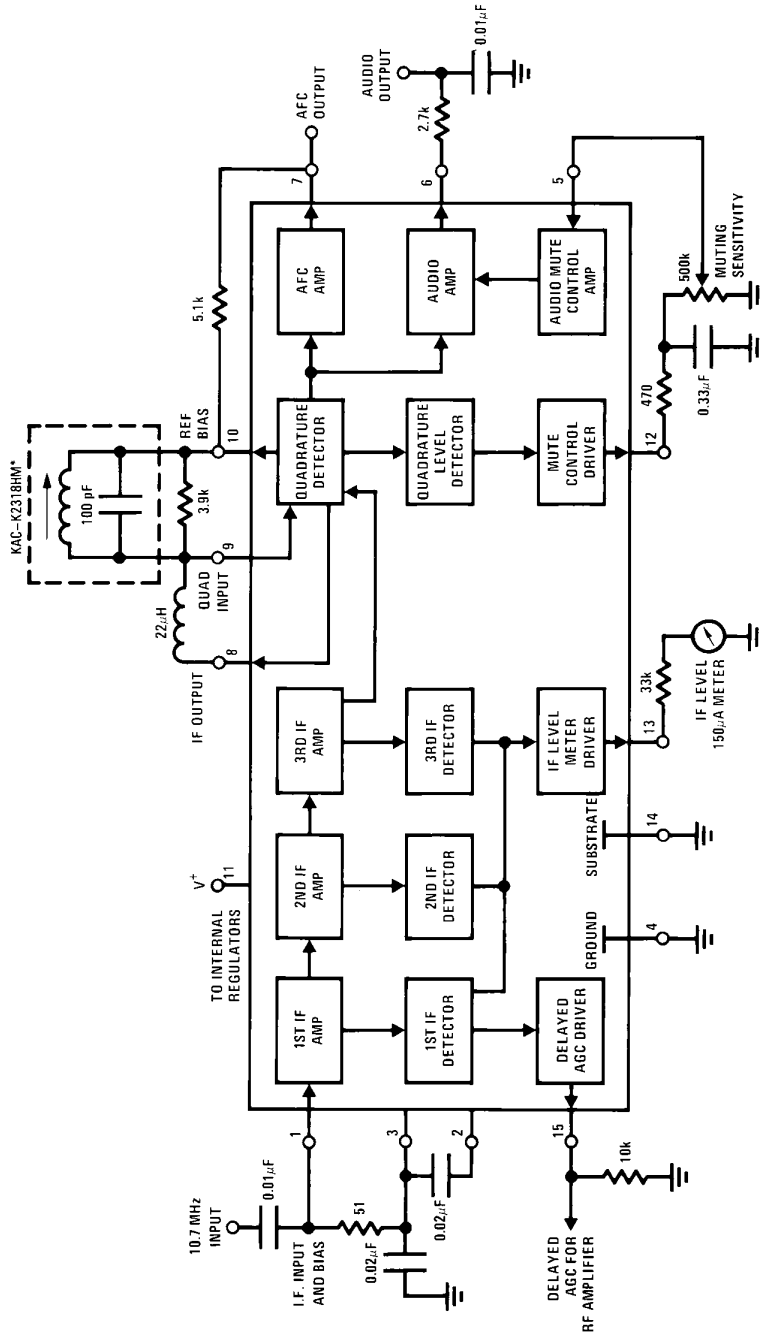

TL/H7149-1

Toko America
1250 Feshtanville Drive
Mount Prospect, IL 60056
(812) 287-0070

Absolute Maximum Ratings

If Military/Aerospace specified devices are required, please contact the National Semiconductor Sales Office/Distributors for availability and specifications.

Supply Voltage Between Pin 11 and Pins 4, 14	+ 16V
DC Current Out of Pin 12	5 mA
DC Current Out of Pin 13	5 mA
DC Current Out of Pin 15	2 mA

Power Dissipation (Note 2)	1500 mW
Operating Temperature Range	-40°C to +85°C
Storage Temperature Range	-65°C to +150°C
Lead Temperature (Soldering, 10 seconds)	260°C

Electrical Characteristics (T_A = 25°C, V_{CC} = +12V, see Test Circuit)

Symbol	Parameter	Conditions	Min	Typ	Max	Units
DC CHARACTERISTICS (V_{IN} = 0, NOT MUTED)						
I ₁₁	Supply Current		16	23	30	mA
V _{1, 2, 3}	IF Input and Bias		1.2	1.9	2.4	V
V ₆	Audio Output		5.0	5.6	6.0	V
V ₇	AFC Output		5.0	5.6	6.0	V
V ₁₀	Reference Bias		5.0	5.6	6.0	V
V ₁₂	Mute Control		5.0	5.4	6.0	V
V ₁₃	IF Level			0	0.5	V
V ₁₅	Delayed AGC		4.2	4.7	5.3	V
DYNAMIC CHARACTERISTICS f_o = 10.7 MHz, Δf = ±75 kHz @ 400 Hz						
V _{IN} (LIM)	Input Limiting -3 dB			12	25	μV
AMR	AM Rejection	V _{IN} = 100 mV, AM: 30%	45	55		-dB
V _O (AF)	Recovered Audio	V _{IN} = 10 mV	300	400	500	mVrms
THD	Total Harmonic Distortion					
	Single Tuned (Note 1)	V _{IN} = 100 mV		0.5	1.0	%
	Double Tuned (Note 1)	V _{IN} = 100 mV		0.1	0.3	%
S+N/N	Signal to Noise Ratio	V _{IN} = 100 mV	60	70		dB
V ₁₂	Mute Control	V _{IN} = 100 mV		0	0.5	V
V ₁₃	IF Level	V _{IN} = 100 mV	4.0	5.0	6.0	V
V ₁₃	IF Level	V _{IN} = 500 μV	1.0	1.5	2.0	V
V ₁₅	Delayed AGC	V _{IN} = 100 mV		0.1	0.5	V
V ₁₅	Delayed AGC	V _{IN} = 30 mV		2.5		V
V _O (AF)	Audio Muted	V _{IN} = 100 mV, V ₅ = +2.5V		60		-dB

Note 1: Distortion is a function of quadrature coil used.

Note 2: For operation in ambient temperatures above 25°C, the device must be derated based on a 150°C maximum junction temperature and a thermal resistance of 80°C/W junction to ambient.

Typical Performance Characteristics

Typical S + N/N and IF Limiting Sensitivity vs IF Input Signal

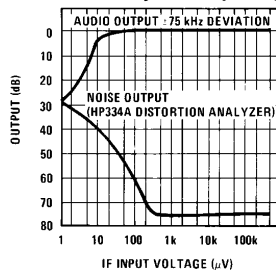

Typical AGC (Pin 15) and Meter Output (Pin 13) vs IF Input Signal

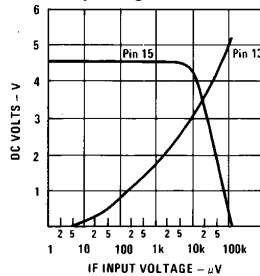

AM Rejection (30% Mod) vs IF Input Signal

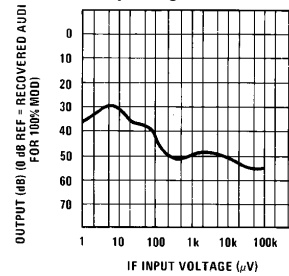

TL/H/7149-3

Schematic Diagram

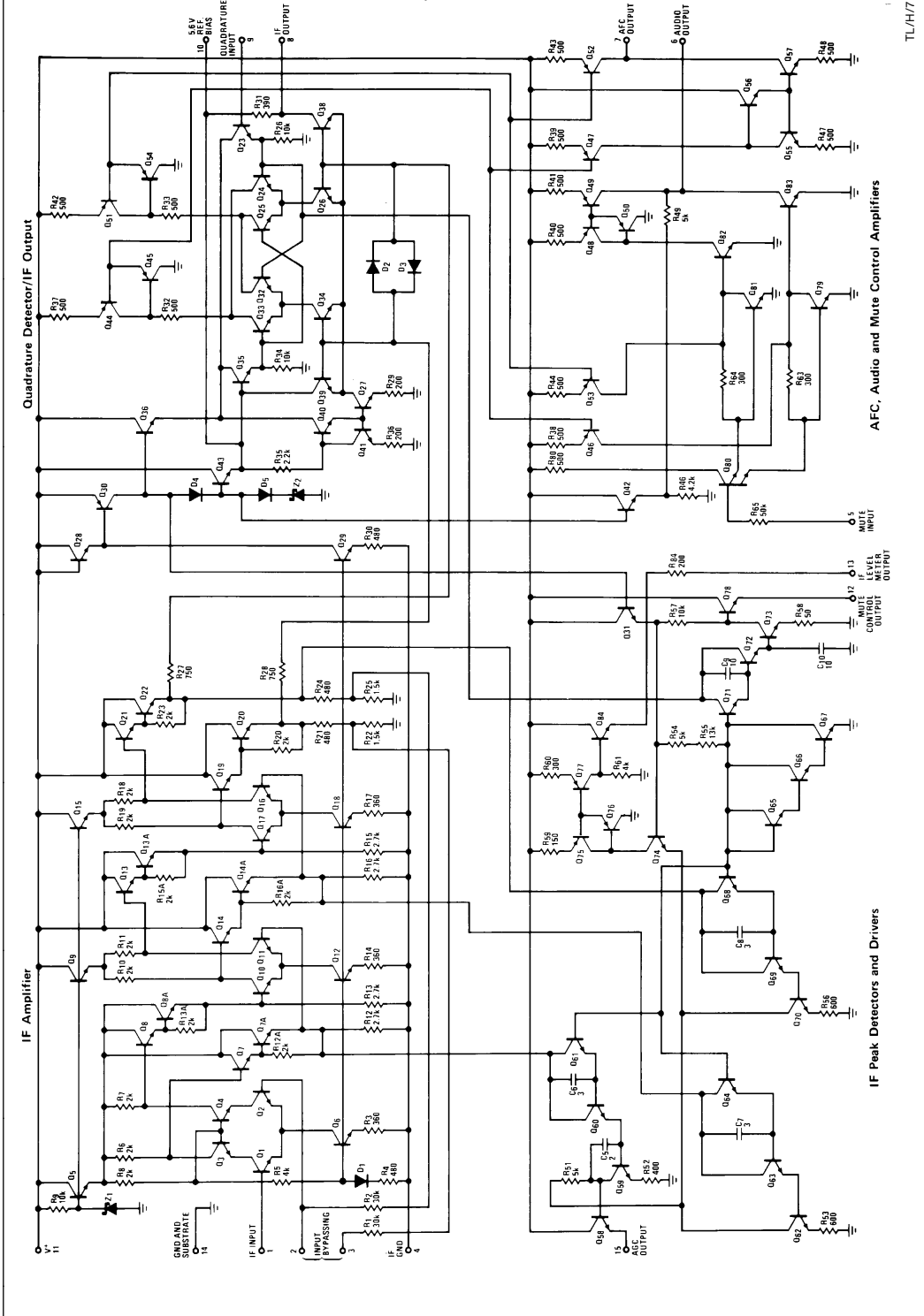

TL/H7149-4

Typical Performance Characteristics

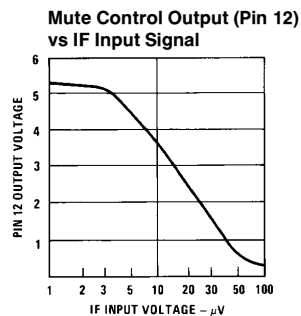
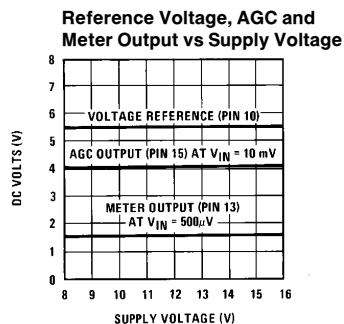
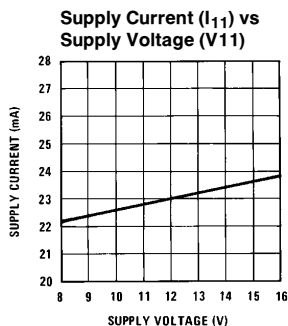

TL/H/7149-5

Typical Audio Attenuation (Pin 6) vs Mute Input Voltage (Pin 5)

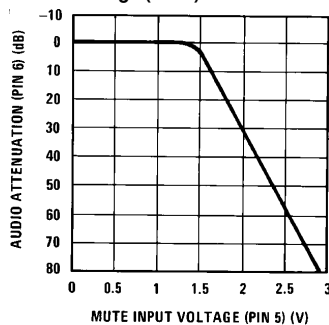

TL/H/7149-6

DC Test Circuit

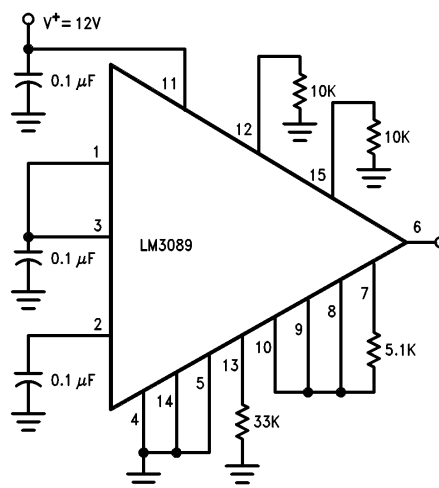

TL/H/7149-7

AC Test Circuit

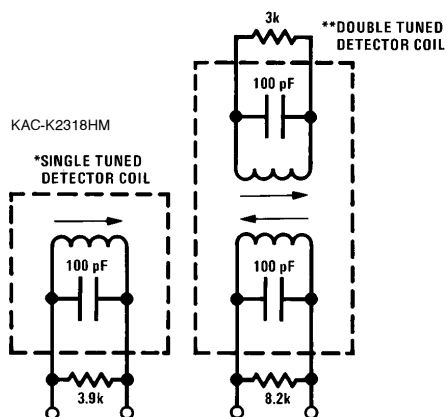

*For single tuned detector coil:
 L_0 tunes with 100 pF at 10.7 MHz
 Q_{UL} (unloaded) ≈ 75
 Q_L (loaded) ≈ 13 for $V_9 \approx 150$ mVrms

**For double tuned detector coil:
 $Q_{ULPRI} = Q_{ULSEC} \approx 75$
 $kQ \approx 0.7$ for $V_9 \approx 150$ mVrms

Note:

The recovered audio output voltage will be approximately 0.5 dB less when using the double tuned detector coil.

For proper operation of the mute circuit, the RF voltage at pin 9 should be 150 mVrms ± 30 mV.

TL/H/7149-8

AC Test Circuit (Continued)

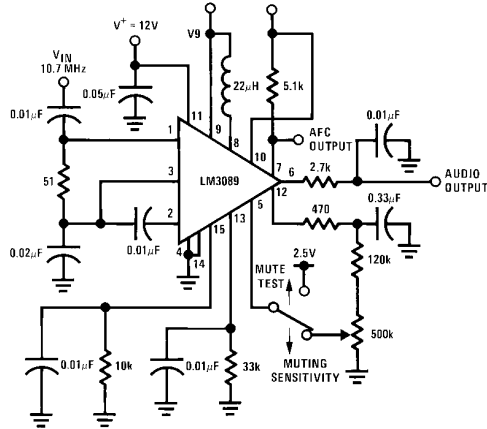

TL/H/7149-9

Physical Dimensions inches (millimeters)

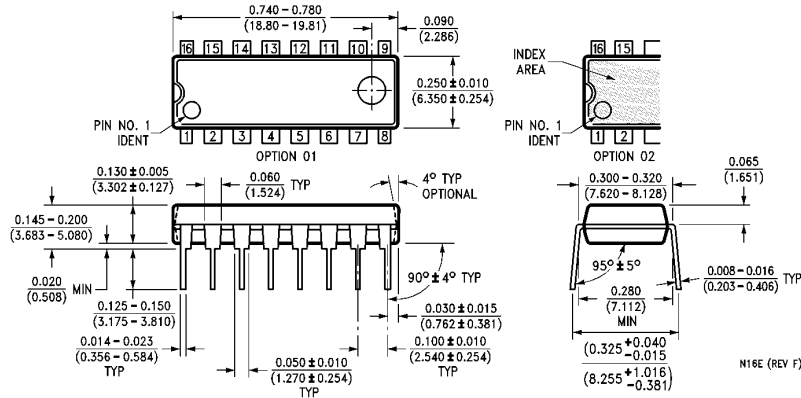

Dual-In-Line Package (N)
Order Number LM3089N
See NS Package Number N16E

LIFE SUPPORT POLICY

NATIONAL'S PRODUCTS ARE NOT AUTHORIZED FOR USE AS CRITICAL COMPONENTS IN LIFE SUPPORT DEVICES OR SYSTEMS WITHOUT THE EXPRESS WRITTEN APPROVAL OF THE PRESIDENT OF NATIONAL SEMICONDUCTOR CORPORATION. As used herein:

1. Life support devices or systems are devices or systems which, (a) are intended for surgical implant into the body, or (b) support or sustain life, and whose failure to perform, when properly used in accordance with instructions for use provided in the labeling, can be reasonably expected to result in a significant injury to the user.
2. A critical component is any component of a life support device or system whose failure to perform can be reasonably expected to cause the failure of the life support device or system, or to affect its safety or effectiveness.



National Semiconductor Corporation
 1111 West Bardin Road
 Arlington, TX 76017
 Tel: 1(800) 272-9959
 Fax: 1(800) 737-7018

National Semiconductor Europe
 Fax: (+49) 0-180-530 85 86
 Email: cnjwge@tevm2.nsc.com
 Deutsch Tel: (+49) 0-180-530 85 85
 English Tel: (+49) 0-180-532 78 32
 Français Tel: (+49) 0-180-532 93 58
 Italiano Tel: (+49) 0-180-534 16 80

National Semiconductor Hong Kong Ltd.
 19th Floor, Straight Block,
 Ocean Centre, 5 Canton Rd.
 Tsimshatsui, Kowloon
 Hong Kong
 Tel: (852) 2737-1600
 Fax: (852) 2736-9960

National Semiconductor Japan Ltd.
 Tel: 81-043-299-2309
 Fax: 81-043-299-2408

National does not assume any responsibility for use of any circuitry described, no circuit patent licenses are implied and National reserves the right at any time without notice to change said circuitry and specifications.