

NOISE

DIODES

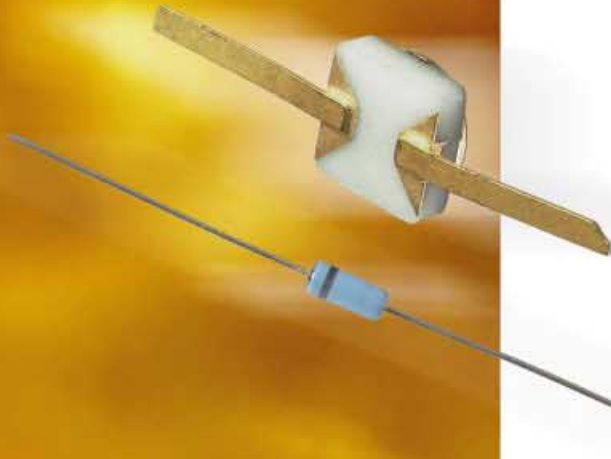

Noise Com's noise diodes are the fundamental building blocks of all noise systems. They are hand-picked for performance characteristics that make them ideally suited to broadband noise generation with flat response.

All Noise Com noise diodes deliver symmetrical white Gaussian noise and flat output power versus frequency. The diodes are burned-in for 168 hours, meet MIL-STD202, and are hermetically sealed. Noise Com noise diodes are available in a wide variety of package styles, and in special configurations on request.

The *NC100* and *NC200 Series* diodes are designed for audio and RF applications. The *NC300* and *NC400 Series* diodes are designed for microwave applications in which a 50-ohm impedance is required.

Typical small signal impedance of the *NC300* and *NC400 Series* is 10-20 ohms when a diode is turned on. Typically the output level is higher at low frequencies with low currents. Driving the diodes with more current results in more output at higher frequencies.

General Specifications:

Output	White Gaussian Noise
Operating temperature	0°C to +55°C for NC100 series -55°C to +125°C for all others
Storage temperature	-65°C to +150°C
Specifications subject to change without notice.	

Applications:

- Built-in test equipment (BITE)
- Dither circuitry for A/D converters

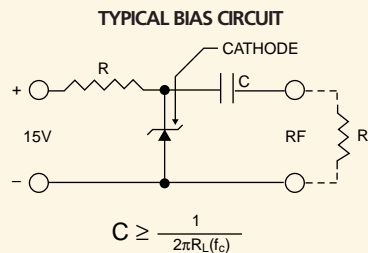

$$C \geq \frac{1}{2\pi R_L(f_c)}$$

f_c = low frequency cut-off

For NC100 Series
R = 150K

For NC200 Series
R = 15K

For NC300/400 Series
R = Adjust for performance

R_L = Load resistor
For recommended value,
see charts on page 31

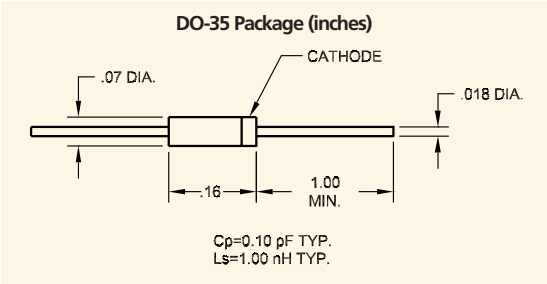
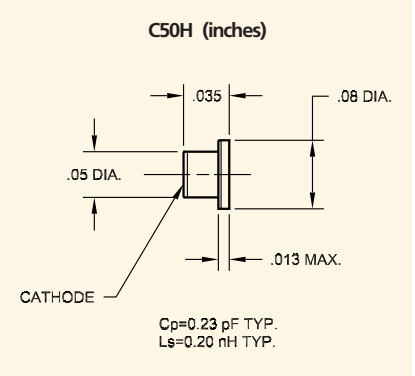
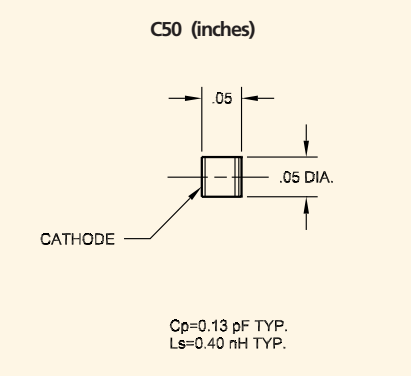
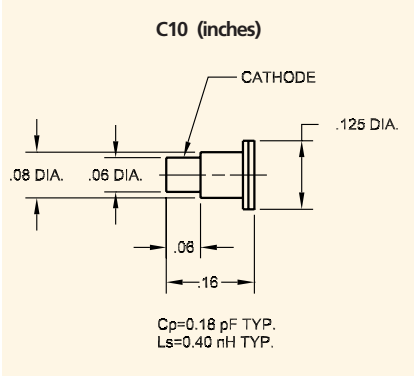
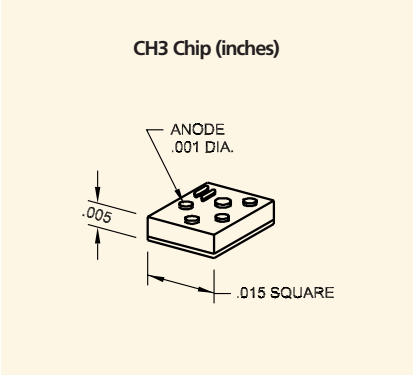
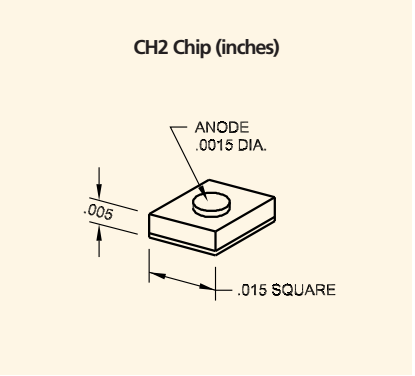
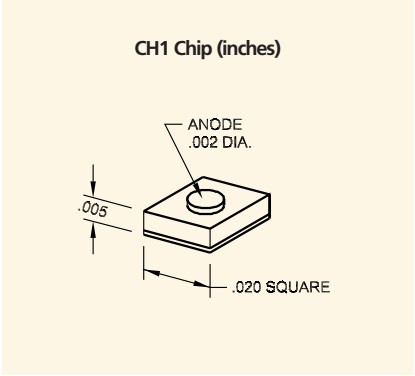

AUDIO & VHF TYPES						
MODEL	FREQUENCY RANGE	OPERATING CONDITIONS		MINIMUM OUTPUT		PACKAGE
		V _b (V)	I _{op}	R _L (Ω)	(μV/√Hz)	
NC101	0.1 Hz - 100 kHz	7 - 10	30 - 60 μA	2200	3.0	DO-35
NC102	0.1 Hz - 500 kHz	7 - 10	30 - 60 μA	2200	3.0	DO-35
NC103	0.1 Hz - 1 MHz	7 - 10	30 - 60 μA	2200	3.0	DO-35
NC104	0.1 Hz - 3 MHz	7 - 10	30 - 60 μA	2200	3.0	DO-35
NC201	0.1 Hz - 10 MHz	7 - 10	0.2 - 0.5 mA	2200	0.1	DO-35
NC202	0.1 Hz - 25 MHz	7 - 10	0.2 - 0.5 mA	2200	0.1	DO-35
NC203	0.1 Hz - 100 MHz	7 - 10	0.2 - 0.5 mA	50	0.05	DO-35

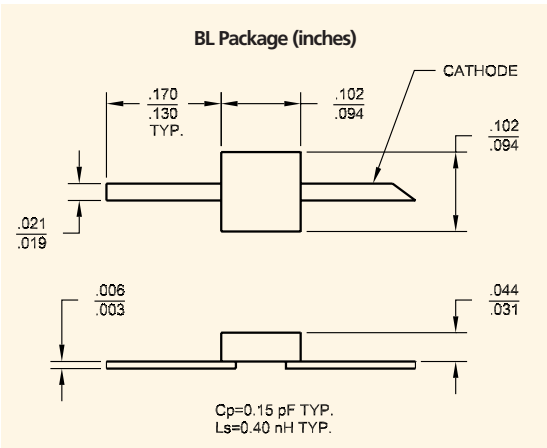

RF & MICROWAVE TYPES						
MODEL	FREQUENCY RANGE	OPERATING CONDITIONS			OUTPUT	PACKAGE
		V _b (V)	I _{op} (mA)	R _L (Ω)	ENR (dB)	
NC302L	10 Hz - 3 GHz	6 - 8	6	50	30 - 35	DO-35 BL CH1
NC303	10 Hz - 8 GHz	8 - 12	8	50	30 - 35	DO-35 BL CH1
NC305	10 MHz - 11 GHz	8 - 12	10	50	29 - 34	BL CH1
NC401	100 MHz - 18 GHz	8 - 12	10	50	30 - 35	C10 C50H CH2
NC403	100 MHz - 27 GHz	8 - 12	12	50	24 - 28	C50 CH3
NC404	18 GHz - 50 GHz	8 - 12	15	50	20 - 25	C50 CH3
NC405	18 GHz - 75 GHz	8 - 12	20	50	15 - 25	C50 CH3
NC406	18 GHz - 110 GHz	8 - 12	25	50	15 - 25	C50 CH3

1. For chip configuration, add suffix "C".
2. For beam lead configuration, add suffix "BL".
3. For C50H configuration, add suffix "H".