

## AUDIO PROCESSOR

### ■ GENERAL DESCRIPTION

The **NJW1145** is a audio processor with sound enhancement (BBE). It includes all of the functions processing audio signal for TV, such as tone control, balance, volume, mute, and AGC functions.

Also the **NJW1145** performs surround and sound enhancement. The sound enhancement regenerates high definitive and nearly real sound.

All of the internal status and variables are controlled by I<sup>2</sup>C BUS interface.

### ■ PACKAGE OUTLINE

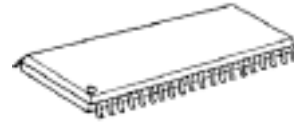

**NJW1145GK1**

### ■ FEATURES

- Operating Voltage 8 to 13V
- I<sup>2</sup>C BUS Interface
- BBE Sound Enhancement (Low Boost and High Boost: 15dB max.)
- Internal 6 Input Audio Selectors and Monitor Output
- The AGC circuit reduces volume difference among input sources.
- Variable AGC Compression Level via I<sup>2</sup>C (4-levels)
- NJRC Surround "eala" and Simulated Surround
- Variable Surround Effect Level via I<sup>2</sup>C
- Low Noise VCA
- Bi-CMOS Technology
- Package Outline SOP40-K1

### ■ BLOCK DIAGRAM

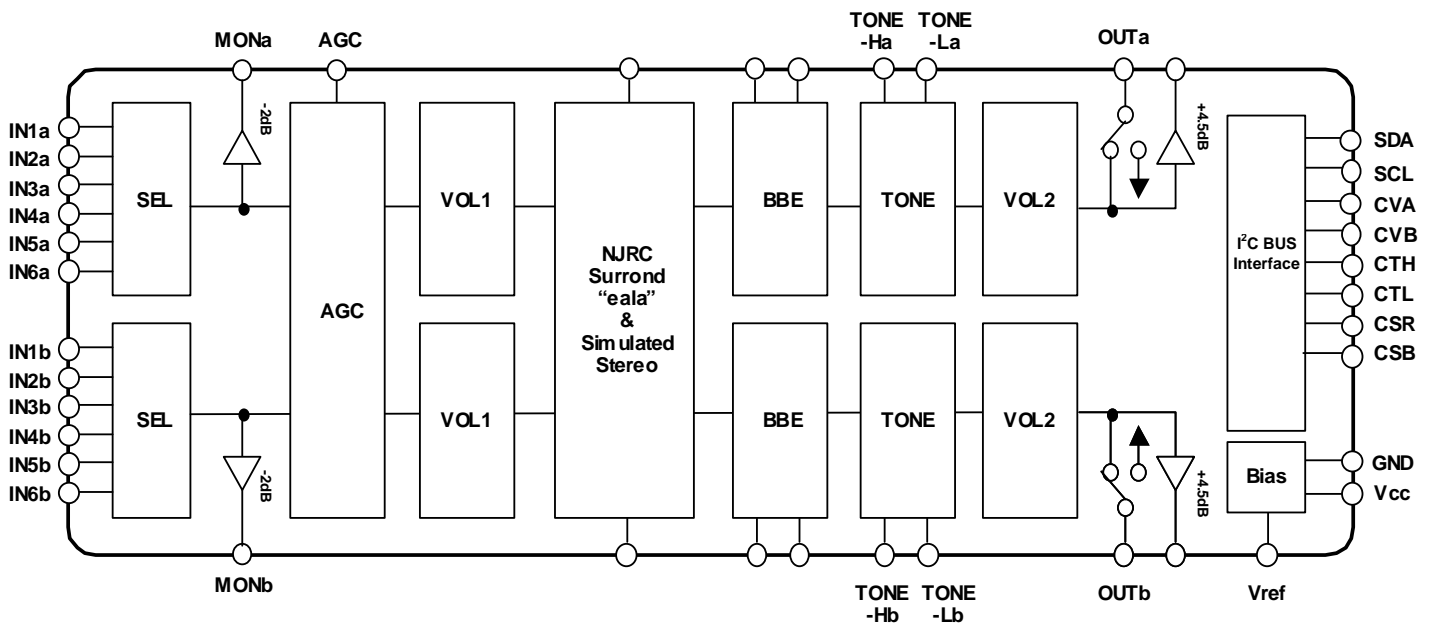

## ■ PIN CONFIGURATION

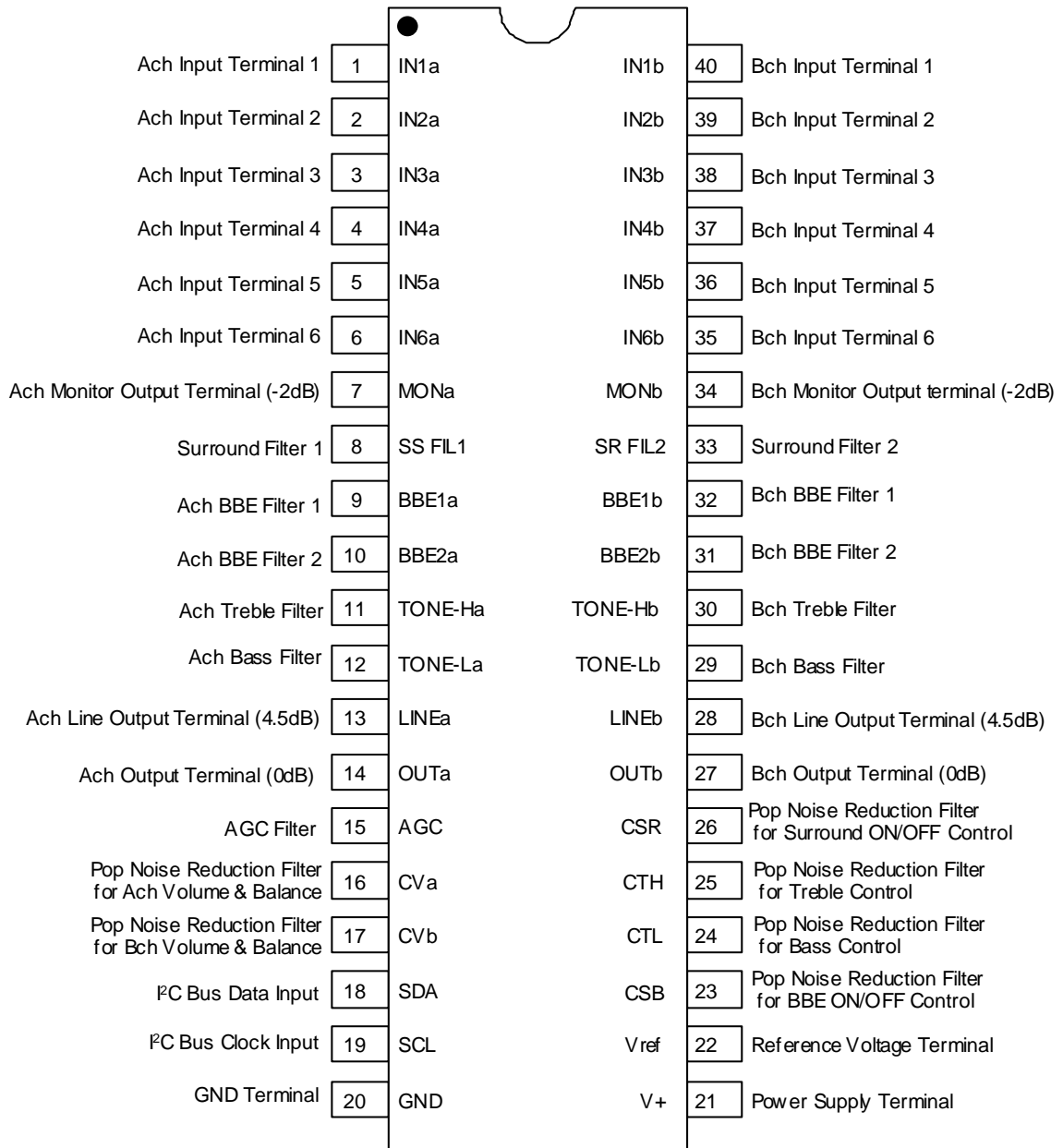

## ■ ABSOLUTE MAXIMUM RATING (Ta=25°C)

PARAMETER	SYMBOL	RATING	UNIT
Supply Voltage	V <sup>+</sup>	14	V
Power Dissipation	P <sub>D</sub>	700	mW
Operating Temperature Range	Topr	-20 to +75	°C
Storage Temperature Range	Tstg	-40 to +125	°C

## ■ ELECTRICAL CHARACTERISTICS ( Ta=25°C, V<sup>+</sup>=9V, R<sub>g</sub>=600Ω, R<sub>L</sub>=47kΩ, Vin=100mVrms/1kHz)

PARAMETER	SYMBOL	TEST CONDITION	MIN.	TYP.	MAX.	UNIT
Operating Voltage	V <sup>+</sup>		8.0	9.0	13.0	V
Supply Current	I <sub>CC</sub>	No Signal	-	13	25	mA
Reference Voltage	V <sub>REF</sub>	No Signal	4.0	4.5	5.0	V
Maximum Input Voltage	V <sub>IM</sub>	VOL=-20dB, THD=1%	2.8	3.0	-	Vrms
Maximum Output Voltage1	V <sub>OM1</sub>	OUTPUT VOL=0dB, THD=1%	-	2.5	-	Vrms
Maximum Output Voltage2	V <sub>OM2</sub>	LINEOUT VOL=0dB, THD=1%	-	2.5	-	Vrms
MON OUT Gain	G <sub>VMON</sub>	MON OUT	-	-2.0	-	dB
LINEOUT Gain	G <sub>VLINE</sub>	LINEOUT, VOL=0dB	2.5	4.5	6.5	dB
Maximum Gain	G <sub>VMAX</sub>	VOL=0dB	-2.0	0.0	2.0	dB
Minimum Gain	G <sub>VMIN</sub>	VOL=Mute, Vin=1Vrms BW=400Hz to 30kHz	-	-	-70	dB
Channel Balance	G <sub>CB</sub>	VOL=0dB	-1.5	0.0	1.5	dB
Balance Level A-A	BAL <sub>AA</sub>	CHS="0",BAL="11111"	-2.0	0.0	2.0	dB
Balance Level A-B	BAL <sub>AB</sub>	CHS="1",BAL="11111" Vin = 1Vrms BW=400Hz to 30kHz	-	-	-70	dB
Balance Level B-B	BAL <sub>BB</sub>	CHS="1",BAL="11111"	-2.0	0.0	2.0	dB
Balance Level B-A	BAL <sub>BA</sub>	CHS="0",BAL="11111" Vin = 1Vrms BW=400Hz to 30kHz	-	-	-70	dB
Total Harmonic Distortion	THD	Vo=0.5Vrms BW=400Hz to 30kHz	-	-	0.5	%
Input Selector Cross Talk	CT	Vin=1Vrms BW=400Hz to 30kHz	-	-	-70	dB
Channel Separation	CS	Vin=1Vrms BW=400Hz to 30kHz	-	-	-70	dB
Output Noise 1	V <sub>NO1</sub>	VOL=0dB BW=400Hz to 30kHz	-	-90 (31.6)	-85 (56.2)	dBV (μVrms)
Output Noise 2	V <sub>NO2</sub>	VOL=Mute BW=400Hz to 30kHz	-	-106 (5.0)	-96 (15.8)	dBV (μVrms)
Output Noise 3	V <sub>NO3</sub>	LINEOUT, VOL=0dB BW=400Hz to 30kHz	-	-85 (56.2)	-80 (100)	dBV (μVrms)
Output Noise 4	V <sub>NO4</sub>	LINEOUT, VOL=Mute BW=400Hz to 30kHz	-	-101 (8.9)	-91 (28.2)	dBV (μVrms)

■ **ELECTRICAL CHARACTERISTICS** ( Ta=25°C, V<sup>+</sup>=9V, R<sub>g</sub>=600Ω, R<sub>L</sub>=47kΩ, V<sub>in</sub>=100mVrms/1kHz)

● **● TONE CONTROL** (Tone Control-ON)

PARAMETER	SYMBOL	TEST CONDITION	MIN.	TYP.	MAX.	UNIT
High Frequency Boost	HF <sub>BST</sub>	TREBLE=+15dB, f=10kHz	12.5	15.0	17.5	dB
High Frequency Flat	HF <sub>FLT</sub>	TRBE=0dB, f=10kHz	-2.0	0.0	2.0	dB
High Frequency Cut	HF <sub>CUT</sub>	TREBLE=-15dB, f=10kHz	-17.5	-15.0	-12.5	dB
Low Frequency Boost	LF <sub>BST</sub>	BASS=+15dB, f=100Hz	12.5	15.0	17.5	dB
Low Frequency Flat	LF <sub>FLT</sub>	BASS=0dB, f=100Hz	-2.0	0.0	2.0	dB
Low Frequency Cut	LF <sub>CUT</sub>	BASS=-15dB, f=100Hz	-17.5	-15.0	-12.5	dB

● **● SUB-TONE CONTROL** (Sub-Tone Control-ON)

PARAMETER	SYMBOL	TEST CONDITION	MIN.	TYP.	MAX.	UNIT
High Frequency Boost	SHF <sub>BST</sub>	SUB-TREBLE=+3dB, f=10kHz	2.0	3.0	4.0	dB
High Frequency Flat	SHF <sub>FLT</sub>	SUB-TREBLE=0dB, f=10kHz	-2.0	0.0	2.0	dB
High Frequency Cut	SHF <sub>CUT</sub>	SUB-TREBLE=-3dB, f=10kHz	-4.0	-3.0	-2.0	dB
Low Frequency Boost	SLF <sub>BST</sub>	SUB-BASS=+3dB, f=100Hz	2.0	3.0	4.0	dB
Low Frequency Flat	SLF <sub>FLT</sub>	SUB-BASS=0dB, f=100Hz	-2.0	0.0	2.0	dB
Low Frequency Cut	SLF <sub>CUT</sub>	SUB-BASS=-3dB, f=100Hz	-4.0	-3.0	-2.0	dB

● **● AGC** (AGC-ON)

PARAMETER	SYMBOL	TEST CONDITION	MIN.	TYP.	MAX.	UNIT
AGC BOOST	AGC <sub>BST</sub>	V <sub>in</sub> =50mVrms	1.5	3.5	5.5	dB
AGC FLAT 1	AGC <sub>FLT1</sub>	V <sub>in</sub> =300mVrms	-2.5	0.0	2.5	dB
AGC FLAT 2	AGC <sub>FLT2</sub>	V <sub>in</sub> =400mVrms	-2.5	0.0	2.5	dB
AGC FLAT 3	AGC <sub>FLT3</sub>	V <sub>in</sub> =500mVrms	-2.5	0.0	2.5	dB
AGC FLAT 4	AGC <sub>FLT4</sub>	V <sub>in</sub> =600mVrms	-2.5	0.0	2.5	dB
AGC CUT	AGC <sub>CUT</sub>	V <sub>in</sub> =2Vrms	-14	-10	-6.0	dB

● **● BBE** (BBE-ON)

PARAMETER	SYMBOL	TEST CONDITION	MIN.	TYP.	MAX.	UNIT
BBE Low Frequency Boost Level	BBE <sub>LOW</sub>	BBE-Low=+15dB	-	15.0	-	dB
BBE High Frequency Boost Level	BBE <sub>HIGH</sub>	BBE-High=+15dB	-	15.0	-	dB

■ **ELECTRICAL CHARACTERISTICS** (  $T_a=25^{\circ}\text{C}$ ,  $V^+=9\text{V}$ ,  $R_g=600\Omega$ ,  $R_L=47\text{k}\Omega$ ,  $V_{in}=100\text{mV}_{rms}$ )

● **SURROUND**

PARAMETER	SYMBOL	TEST CONDITION	MIN.	TYP.	MAX.	UNIT
SURROUND SIM A	$SR_{SIMA}$	$A_{in}+B_{in} \rightarrow A_{out}$ , $f=1\text{kHz}$	1.0	3.0	5.0	dB
SURROUND SIM B	$SR_{SIMB}$	$A_{in}+B_{in} \rightarrow B_{out}$ , $f=1\text{kHz}$	1.0	3.0	5.0	dB
SURROUND 3D 1	$SR_{3D1}$	$A_{in} \rightarrow A_{out}$ , $f=100\text{Hz}$	8.0	10.0	12.0	dB
SURROUND 3D 2	$SR_{3D2}$	$A_{in} \rightarrow A_{out}$ , $f=10\text{kHz}$	-2.0	0.0	2.0	dB
SURROUND 3D 3	$SR_{3D3}$	$A_{in} \rightarrow B_{out}$ , $f=100\text{Hz}$	4.5	6.5	8.5	dB

## ■ I<sup>2</sup>C BUS Block CHARACTERISTICS (SDA, SCL)

PARAMETER	SYMBOL	MIN.	TYP.	MAX.	UNIT
High Level Input Voltage	V <sub>IH</sub>	3.0	-	5.0	V
Low Level Input Voltage	V <sub>IL</sub>	0	-	1.5	V
High Level Input Current	I <sub>IH</sub>	-	-	10	μA
Low Level Input Current	I <sub>IL</sub>	-	-	10	μA
Low Level Output Voltage (3mA at SDA pin)	V <sub>OL</sub>	0	-	0.4	V
Maximum Output Current	I <sub>OL</sub>	-3.0	-	-	mA
Maximum Clock Frequency	f <sub>SCL</sub>	-	-	100	kHz
Data Change Minimum Waiting Time	t <sub>BUF</sub>	4.7	-	-	μS
Data Transfer Start Minimum Waiting Time	t <sub>HD:STA</sub>	4.0	-	-	μS
Low Level Clock Pulse Width	t <sub>LOW</sub>	4.7	-	-	μS
High Level Clock Pulse Width	t <sub>HIGH</sub>	4.0	-	-	μS
Minimum Start Preparation Waiting Time	t <sub>SU:STA</sub>	4.7	-	-	μS
Minimum Data Hold Time	t <sub>HD:DAT</sub>	0	-	3.45	μS
Minimum Data Preparation Time	t <sub>SU:DAT</sub>	250	-	-	nS
Rise Time	t <sub>R</sub>	-	-	1.0	μS
Fall Time	t <sub>F</sub>	-	-	300	nS
Minimum Stop Preparation Waiting Time	t <sub>SU:STO</sub>	4.0	-	-	μS

I<sup>2</sup>C BUS Load Condition: Pull up resistance 4kΩ (Connected to +5V)  
Load capacitance 200pF (Connected to GND)

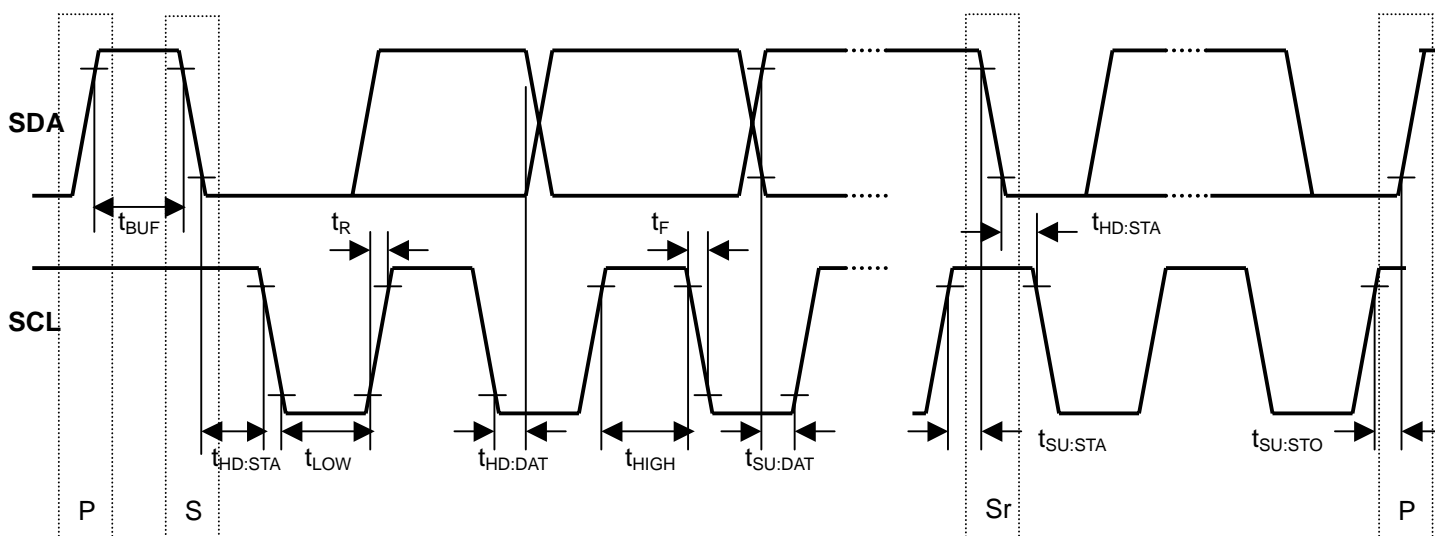

## ■ TERMINAL DESCRIPTION

No.	SYMBOL	FUNCTION	EQUIVALENT CIRCUIT	VOLTAGE
1 2 3 4 5 6 35 36 37 38 39 40	IN1a IN2a IN3a IN4a IN5a IN6a IN6b IN5b IN4b IN3b IN2b IN1b	Ach Input Terminal 1 Ach Input Terminal 2 Ach Input Terminal 3 Ach Input Terminal 4 Ach Input Terminal 5 Ach Input Terminal 6 Bch Input Terminal 6 Bch Input Terminal 5 Bch Input Terminal 4 Bch Input Terminal 3 Bch Input Terminal 2 Bch Input Terminal 1		V+/2
7 13 14 27 28 34	MONa LINEa OUTa OUTb LINEb MONb	Ach Monitor Output Terminal (-2dB) Ach Line Output Terminal (4.5dB) Ach Output Terminal (0dB) Bch Output Terminal (0dB) Bch Line Output Terminal (4.5dB) Bch Monitor Output Terminal (-2dB)		V+/2
8	SS FIL	Surround Filter 1		V+/2
9 10 31 32	BBE1a BBE2a BBE2b BBE1b	Ach BBE Filter 1 Ach BBE Filter 2 Bch BBE Filter 2 Bch BBE Filter 1		V+/2
11 30	TONE-Ha TONE-Hb	Ach Treble Filter Bch Treble Filter		V+/2

## ■TERMINAL DESCRIPTION

No.	SYMBOL	FUNCTION	EQUIVALENT CIRCUIT	VOLTAGE
12 29	TONE-La TONE-Lb	Ach Bass Filter Bch Bass Filter		V+/2
15	AGC	AGC Filter		0.9V
16 17	CVa CVb	Pop Noise Reduction Filter for Ach Volume & Balance Pop Noise Reduction Filter for Bch Volume & Balance		V+/2 - 0.7V
18 19	SDA SCL	I <sup>2</sup> C Bus Data Input I <sup>2</sup> C Bus Clock Input		-
20	GND	GND Terminal	—	0V
21	V+	Power Supply Terminal	—	GND



## ■ TERMINAL DESCRIPTION

No.	SYMBOL	FUNCTION	EQUIVALENT CIRCUIT	VOLTAGE
22	Vref	Reference Voltage		$V+ / 2$
23	CSB	Pop Noise Reduction Filter for BBE ON/OFF Control		$V+ / 2$
24 25	CTL CTH	Pop Noise Reduction Filter for Bass Control Pop Noise Reduction Filter for Treble Control		$V+ / 2$
26	CSR	Pop Noise Reduction Filter for Surround ON/OFF Control		$V+ / 2$
33	SR FI12	Surround Filter 2		$V+ / 2$

## APPLICATION CIRCUIT

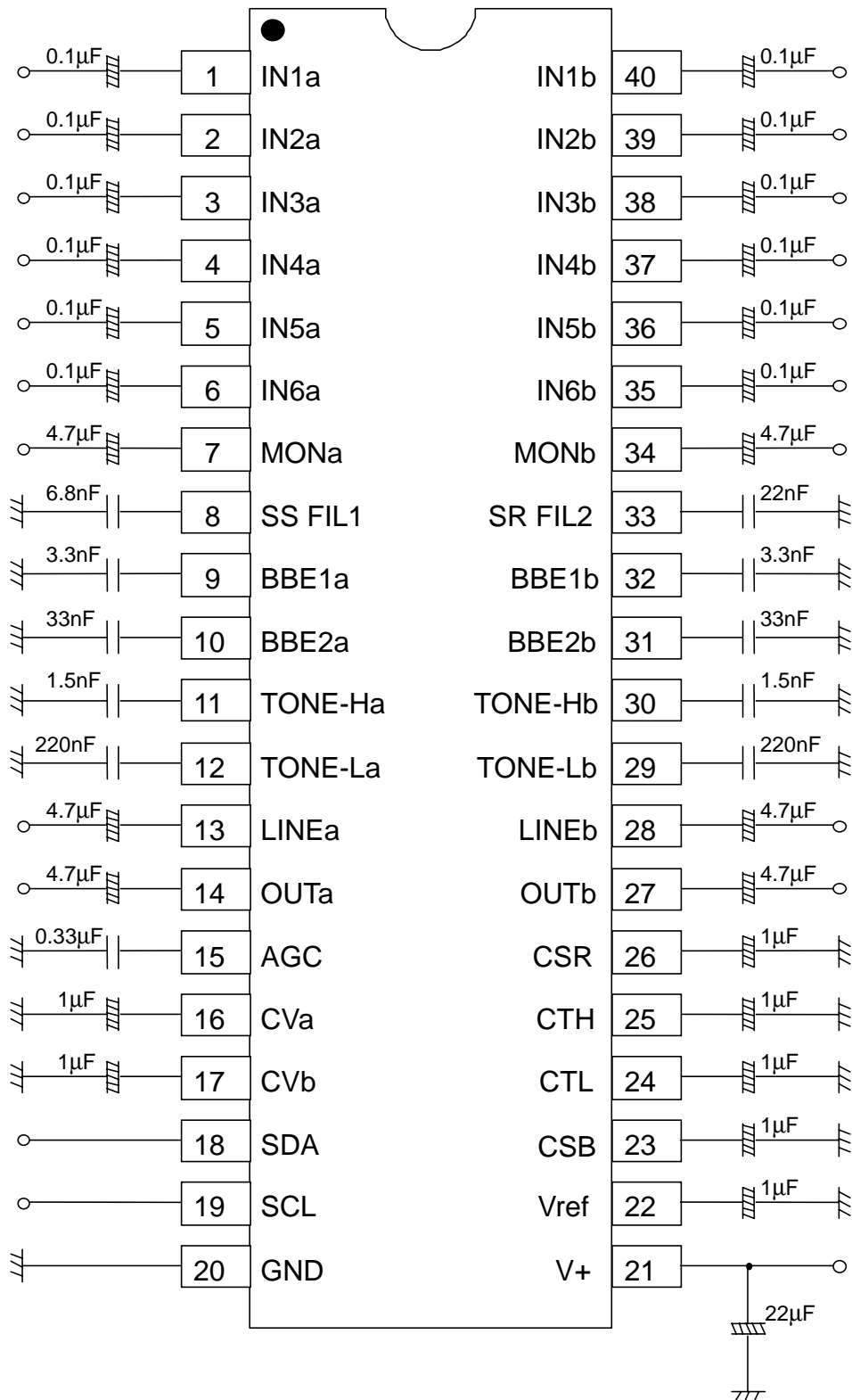

**(NOTE)**

1. Separate the I<sup>2</sup>C bus line from the following terminals for avoiding digital noise problem.

Pin No.	Symbol	Pin No.	Symbol	Pin No.	Symbol	Pin No.	Symbol	Pin No.	Symbol
8	SS FIL1	10	BBE2a	12	TONE-La	30	TONE-Hb	32	BBE1b
9	BBE1a	11	TONE-Ha	29	TONE-Lb	31	BBE2b	33	SR FIL2

## ■ DEFINITION OF I<sup>2</sup>C REGISTER

### ● I<sup>2</sup>C BUS FORMAT

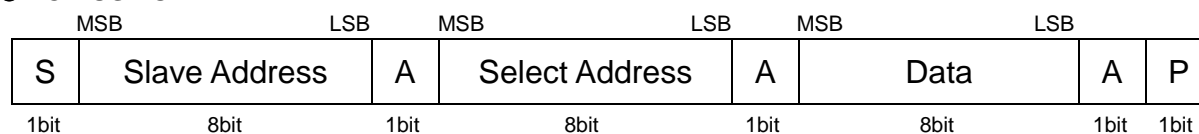

S: Starting Term  
A: Acknowledge Bit  
P: Ending Term

### ● SLAVE ADDRESS

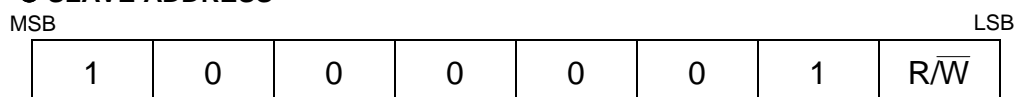

$\overline{R/W}=0$ : Write mode for register setting  
 $\overline{R/W}=1$ : Not available

### ● CONTROL REGISTER TABLE

Select Address	BIT							
	D7	D6	D5	D4	D3	D2	D1	D0
00H	VOL							
01H	CHS	BAL					SR1	SR0
02H	BCB	BASS			BCSB	SUB-BASS		
03H	BCT	TREB			BCST	SUB-TREB		
04H	BBE-Low				BBE-High			
05H	OUT	SEL			AGC1	AGC0	AGC	BBE

### ● CONTROL REGISTER DEFAULT VALUE

Select Address	BIT							
	D7	D6	D5	D4	D3	D2	D1	D0
00H	0	0	0	0	0	0	0	0
01H	0	0	0	0	0	0	0	0
02H	0	0	0	0	0	0	0	0
03H	0	0	0	0	0	0	0	0
04H	0	0	0	0	0	0	0	0
05H	0	0	0	0	0	0	0	0

## ■ I<sup>2</sup>C CONTROL COMMAND DESCRIPTION

### ● MASTER VOLUME CONTROL

Select Address	BIT							
	D7	D6	D5	D4	D3	D2	D1	D0
00H	VOL							

The attenuator is consisted of both the Volume1 and Volume2. The total attenuation level is summing of each attenuation level of the Volume1 and Volume2. The attenuation for both the Volume1 and Volume2 are always synchronized to have the same attenuation levels for each other, and are not controllable independently for each other.

- "VOL": Sets the total attenuation level for the both Ach and Bch (up to 84dB, 0.33dB/step)

### ● CHANNEL BALANCE AND SURROUND MODE CONTROL

Select Address	BIT							
	D7	D6	D5	D4	D3	D2	D1	D0
01H	CHS	BAL					SR1	SR0

#### ◆ Channel Balance Control

To control the balance between Ach and Bch, the both commands "CHS" and "BAL" should be set. For example, to move a sound image to Ach-side, Bch should be attenuated with no attenuation on Ach. The command "CHS" defines the channel should be attenuate, and the command "BAL" defines the attenuation level itself. The attenuation for the balance control is consisted of the both Volume1 and Volume2, has the same structure with Master Volume Control described above.

- "CHS": Defines the channel should be attenuated

The channel should be attenuated	CHS (D7)
Bch	0
Ach	1

- "BAL": Defines the attenuation level for the specified channel with command "CHS" (up to 30dB, 1dB/Step)

#### ◆ Surround Mode Control

- "SR1", "SR0": Surround Mode Switch

Surround Mode	SR1 (D1)	SR0 (D0)
Surround OFF (Bypass)	0	0
Simulated Surround	0	1
3D Surround – High Mode	1	0
3D Surround – Low Mode	1	1

## ●BASS-TONE CONTROL SETTING

Select Address	BIT							
	D7	D6	D5	D4	D3	D2	D1	D0
02H	BCB	BASS				BCSB	SUB-BASS	

- "BCB": Defines the Bass-Tone Control Mode as Boost or Cut

Bass Tone Control Mode	BCB (D7)
Cut	0
Boost	1

- "BASS": Sets the Cut or Boost level for Bass-Tone Control (up to 15dB, 1dB/Step)

- "BCSB": Defines the Sub-Bass-Tone Control Mode as Boost or Cut

Sub-Bass Tone Control Mode	BCSB (D2)
Cut	0
Boost	1

- "SUB-BASS": Sets the Cut or Boost level for Sub-Bass-Tone Control (up to 3dB, 1dB/Step)

## ●TREBLE-TONE CONTROL SETTING

Select Address	BIT							
	D7	D6	D5	D4	D3	D2	D1	D0
03H	BCT	TREB				BCST	SUB-TREB	

- "BCT": Defines the Treble-Tone Control Mode as Boost or Cut

Treble-Tone Control Mode	BCT (D7)
Cut	0
Boost	1

- "TREB": Sets the Cut or Boost level for Treble-Tone Control (up to 15dB, 1dB/Step)

- "BCST": Defines the Sub-Treble-Tone Control Mode as Boost or Cut

Sub-Treble-Tone Control Mode	BCST (D2)
Cut	0
Boost	1

- "SUB-TREB": Sets the Cut or Boost level for Sub-Treble-Tone Control (up to 3dB, 1dB/Step)

## ●BBE BOOST LEVEL SETTING

Select Address	BIT							
	D7	D6	D5	D4	D3	D2	D1	D0
04H	BBE-Low				BBE-High			

The command "BBE-Low" and "BBE-High" can set the only BBE boost level, not BBE ON/OFF control. To activate the BBE, the command "BBE" (Address=05H) must be ON.

- "BBE-Low": Sets the BBE low frequency boost level (up to 15dB, 1dB/Step)
- "BBE-High": Sets the BBE high frequency boost level (up to 15dB, 1dB/Step)

## ●OUTPUT ON/OFF, INPUT SELECTOR, AGC and BBE ON/OFF CONTROL

Select Address	BIT							
	D7	D6	D5	D4	D3	D2	D1	D0
05H	OUT	SEL			AGC1	AGC0	AGC	BBE

### ◆Output ON/OFF

- "OUT": Output ON/OFF Switch

Output	OUT (D7)
Output OFF (Mute)	0
Output ON	1

### ◆Input Selector

- "SEL": Input Selector Control

Input Select	SEL		
	D6	D5	D4
IN1a and IN1b	0	0	0
IN2a and IN2b	0	0	1
IN3a and IN3b	0	1	0
IN4a and IN4b	0	1	1
IN5a and IN5b	1	0	0
IN6a and IN6b	1	0	1

### ◆AGC Control

- "AGC1", "AGC0": Set the AGC Flat Level
- "AGC": AGC ON/OFF Switch

AGC Flat Level	AGC1 (D3)	AGC0 (D2)	AGC (D0)
300mVrms	0	0	1
400mVrms	0	1	1
500mVrms	1	0	1
600mVrms	1	1	1
AGC OFF	-	-	0

### ◆BBE ON/OFF Control

- "BBE": BBE ON/OFF Switch

BBE ON/OFF	BBE (D0)
BBE OFF	0
BBE ON	1

●MASTER VOLUME CONTROL (Select Address: 00H)

Gain (dB)	HEX	VOL							
		D7	D6	D5	D4	D3	D2	D1	D0
0	FF	1	1	1	1	1	1	1	1
-1	FC	1	1	1	1	1	1	0	0
-2	F9	1	1	1	1	1	0	0	1
-3	F6	1	1	1	1	0	1	1	0
-4	F3	1	1	1	1	0	0	1	1
-5	F0	1	1	1	1	0	0	0	0
-6	ED	1	1	1	0	1	1	0	1
-7	EA	1	1	1	0	1	0	1	0
-8	E7	1	1	1	0	0	1	1	1
-9	E4	1	1	1	0	0	1	0	0
-10	E1	1	1	1	0	0	0	0	1
-11	DE	1	1	0	1	1	1	1	0
-12	DB	1	1	0	1	1	0	1	1
-13	D8	1	1	0	1	1	0	0	0
-14	D5	1	1	0	1	0	1	0	1
-15	D2	1	1	0	1	0	0	1	0
-16	CF	1	1	0	0	1	1	1	1
-17	CC	1	1	0	0	1	1	0	0
-18	C9	1	1	0	0	1	0	0	1
-19	C6	1	1	0	0	0	1	1	0
-20	C3	1	1	0	0	0	0	1	1
-21	C0	1	1	0	0	0	0	0	0
-22	BD	1	0	1	1	1	1	0	1
-23	BA	1	0	1	1	1	0	1	0
-24	B7	1	0	1	1	0	1	1	1
-25	B4	1	0	1	1	0	1	0	0
-26	B1	1	0	1	1	0	0	0	1
-27	AE	1	0	1	0	1	1	1	0
-28	AB	1	0	1	0	1	0	1	1
-29	A8	1	0	1	0	1	0	0	0
-30	A5	1	0	1	0	0	1	0	1
-31	A2	1	0	1	0	0	0	1	0
-32	9F	1	0	0	1	1	1	1	1
-33	9C	1	0	0	1	1	1	0	0
-34	99	1	0	0	1	1	0	0	1
-35	96	1	0	0	1	0	1	1	0
-36	93	1	0	0	1	0	0	1	1
-37	90	1	0	0	1	0	0	0	0
-38	8D	1	0	0	0	1	1	0	1
-39	8A	1	0	0	0	1	0	1	0
-40	87	1	0	0	0	0	1	1	1

## ●MASTER VOLUME CONTROL (cont'd)

Gain (dB)	HEX	VOL							
		D7	D6	D5	D4	D3	D2	D1	D0
-41	84	1	0	0	0	0	1	0	0
-42	81	1	0	0	0	0	0	0	1
-43	7E	0	1	1	1	1	1	1	0
-44	7B	0	1	1	1	1	0	1	1
-45	78	0	1	1	1	1	0	0	0
-46	75	0	1	1	1	0	1	0	1
-47	72	0	1	1	1	0	0	1	0
-48	6F	0	1	1	0	1	1	1	1
-49	6C	0	1	1	0	1	1	0	0
-50	69	0	1	1	0	1	0	0	1
-51	66	0	1	1	0	0	1	1	0
-52	63	0	1	1	0	0	0	1	1
-53	60	0	1	1	0	0	0	0	0
-54	5D	0	1	0	1	1	1	0	1
-55	5A	0	1	0	1	1	0	1	0
-56	57	0	1	0	1	0	1	1	1
-57	54	0	1	0	1	0	1	0	0
-58	51	0	1	0	1	0	0	0	1
-59	4E	0	1	0	0	1	1	1	0
-60	4B	0	1	0	0	1	0	1	1
-61	48	0	1	0	0	1	0	0	0
-62	45	0	1	0	0	0	1	0	1
-63	42	0	1	0	0	0	0	1	0
-64	3F	0	0	1	1	1	1	1	1
-65	3C	0	0	1	1	1	1	0	0
-66	39	0	0	1	1	1	0	0	1
-67	36	0	0	1	1	0	1	1	0
-68	33	0	0	1	1	0	0	1	1
-69	30	0	0	1	1	0	0	0	0
-70	2D	0	0	1	0	1	1	0	1
-71	2A	0	0	1	0	1	0	1	0
-72	27	0	0	1	0	0	1	1	1
-73	24	0	0	1	0	0	1	0	0
-74	21	0	0	1	0	0	0	0	1
-75	1E	0	0	0	1	1	1	1	0
-76	1B	0	0	0	1	1	0	1	1
-77	18	0	0	0	1	1	0	0	0
-78	15	0	0	0	1	0	1	0	1
-79	12	0	0	0	1	0	0	1	0
-80	0F	0	0	0	0	1	1	1	1
-81	0C	0	0	0	0	1	1	0	0
-82	09	0	0	0	0	1	0	0	1
-83	06	0	0	0	0	0	1	1	0
-84	03	0	0	0	0	0	0	1	1
Mute	00	0	0	0	0	0	0	0	0



●CHANNEL BALANCE CONTROL (Select Address: 01H)

Gain (dB)	BAL				
	D6	D5	D4	D3	D2
0	0	0	0	0	0
-1	0	0	0	0	1
-2	0	0	0	1	0
-3	0	0	0	1	1
-4	0	0	1	0	0
-5	0	0	1	0	1
-6	0	0	1	1	0
-7	0	0	1	1	1
-8	0	1	0	0	0
-9	0	1	0	0	1
-10	0	1	0	1	0
-11	0	1	0	1	1
-12	0	1	1	0	0
-13	0	1	1	0	1
-14	0	1	1	1	0
-15	0	1	1	1	1
-16	1	0	0	0	0
-17	1	0	0	0	1
-18	1	0	0	1	0
-19	1	0	0	1	1
-20	1	0	1	0	0
-21	1	0	1	0	1
-22	1	0	1	1	0
-23	1	0	1	1	1
-24	1	1	0	0	0
-25	1	1	0	0	1
-26	1	1	0	1	0
-27	1	1	0	1	1
-28	1	1	1	0	0
-29	1	1	1	0	1
-30	1	1	1	1	0
Mute	1	1	1	1	1

●BASS-TONE CONTROL (Select Address: 02H)  
/ TREBLE-TONE CONTROL (Select Address: 03H)

		BASS TREB			
Cut Gain (dB)	Boost Gain (dB)	D6	D5	D4	D3
0	0	0	0	0	0
-1	1	0	0	0	1
-2	2	0	0	1	0
-3	3	0	0	1	1
-4	4	0	1	0	0
-5	5	0	1	0	1
-6	6	0	1	1	0
-7	7	0	1	1	1
-8	8	1	0	0	0
-9	9	1	0	0	1
-10	10	1	0	1	0
-11	11	1	0	1	1
-12	12	1	1	0	0
-13	13	1	1	0	1
-14	14	1	1	1	0
-15	15	1	1	1	1

●SUB-BASS-TONE CONTROL (Select Address: 02H)  
/ SUB-TREBLE-TONE CONTROL (Select Address: 03H)

		SUB-BASS SUB-TREB	
Cut Gain (dB)	Boost Gain (dB)	D1	D0
0	0	0	0
-1	1	0	1
-2	2	1	0
-3	3	1	1

●BBE Low-Frequency Boost Level (Select Address: 04H)

Boost Gain (dB)	BBE-Low			
	D6	D5	D4	D3
0	0	0	0	0
1	0	0	0	1
2	0	0	1	0
3	0	0	1	1
4	0	1	0	0
5	0	1	0	1
6	0	1	1	0
7	0	1	1	1
8	1	0	0	0
9	1	0	0	1
10	1	0	1	0
11	1	0	1	1
12	1	1	0	0
13	1	1	0	1
14	1	1	1	0
15	1	1	1	1

●BBE High-Frequency Boost Level (Select Address: 04H)

Boost Gain (dB)	BBE-High			
	D3	D2	D1	D0
0	0	0	0	0
1	0	0	0	1
2	0	0	1	0
3	0	0	1	1
4	0	1	0	0
5	0	1	0	1
6	0	1	1	0
7	0	1	1	1
8	1	0	0	0
9	1	0	0	1
10	1	0	1	0
11	1	0	1	1
12	1	1	0	0
13	1	1	0	1
14	1	1	1	0
15	1	1	1	1

## TYPICAL CHARACTERISTICS

### Supply Current vs Supply Voltage

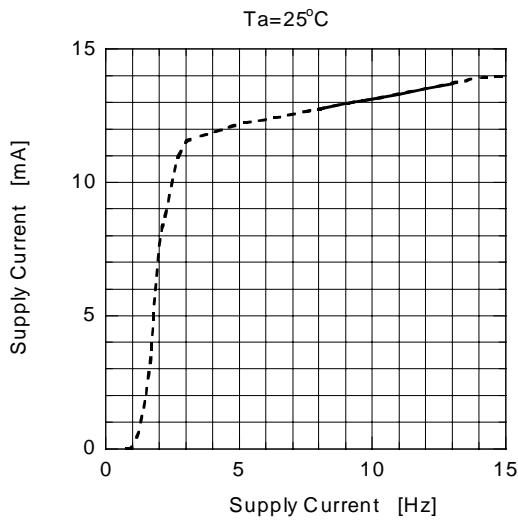

### Supply Current vs Temperature

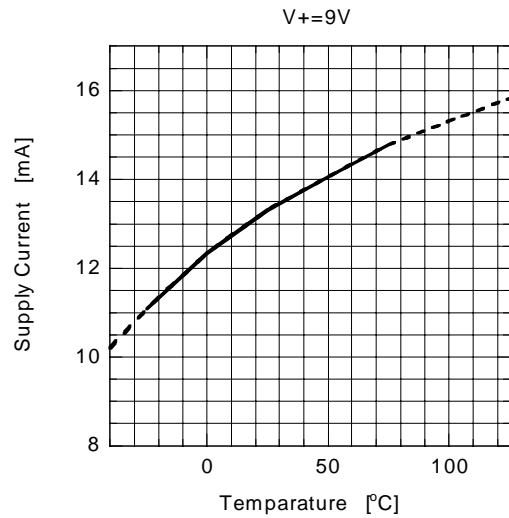

### Gain vs Volume Control

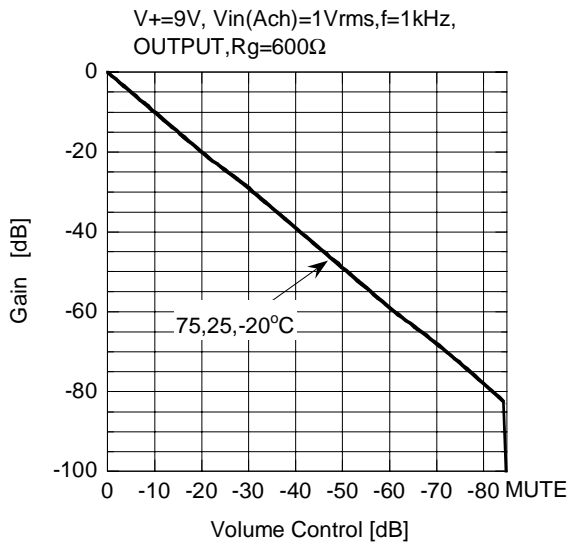

### Gain vs Balance Control

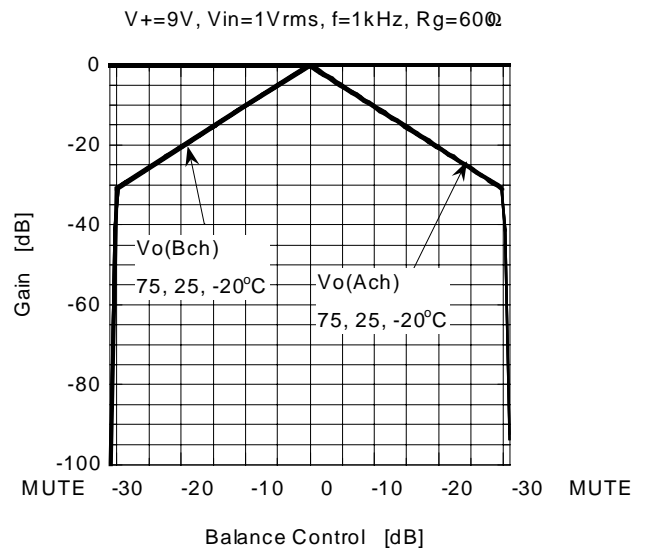

### Output Noise vs Volume Control

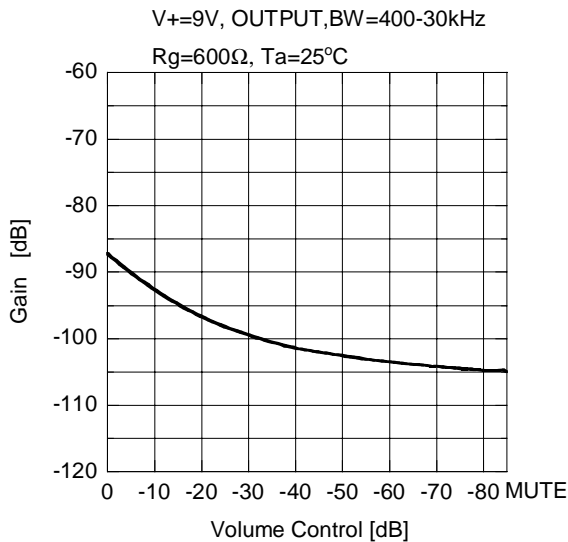

### Output Noise vs Temperature

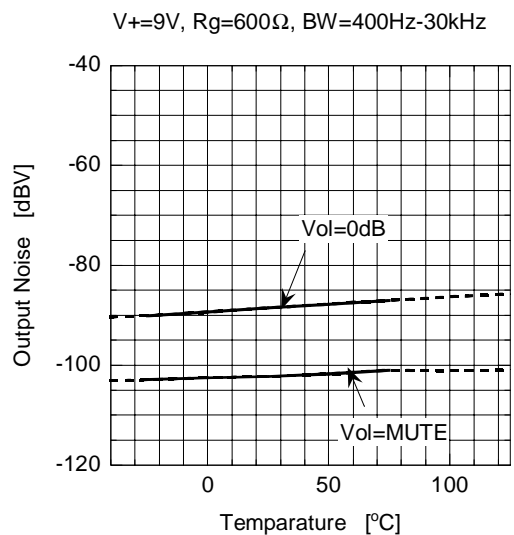

## TYPICAL CHARACTERISTICS

### THD+N vs Input Voltage

$V_{+}=9V$ ,  $V_{in}(Ach)$ ,  $f=1kHz$ ,  $V_{o}(Ach)OUTPUT$   
 $R_g=600\Omega$ ,  $BW=400Hz-30kHz$ ,  $T_a=25^{\circ}C$

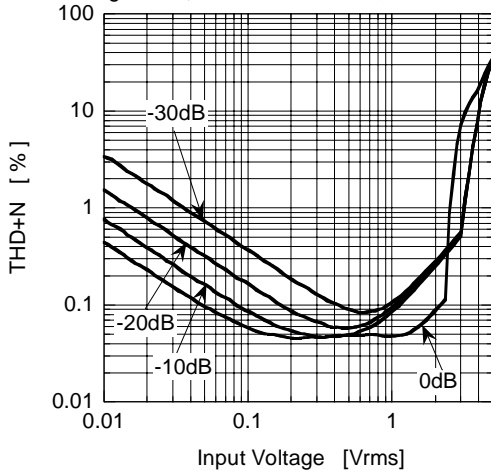

### THD+N vs Input Voltage

$V_{+}=9V$ ,  $V_{in}(Ach)$ ,  $f=1kHz$ ,  $V_{o}(Ach)OUTPUT$   
 $R_g=600\Omega$ ,  $BW=400Hz-30kHz$ ,  $V_{ol}=-20dB$

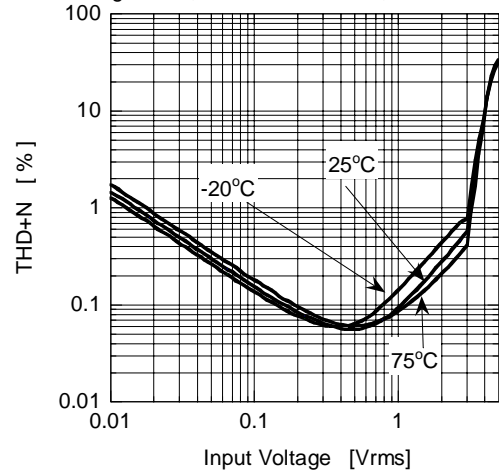

### THD+N vs Output Voltage

$V_{+}=9V$ ,  $V_{in}(Ach)$ ,  $f=1kHz$ ,  $V_{o}(Ach)OUTPUT$   
 $BW=400Hz-30kHz$ ,  $R_g=600\Omega$ ,  $T_a=25^{\circ}C$

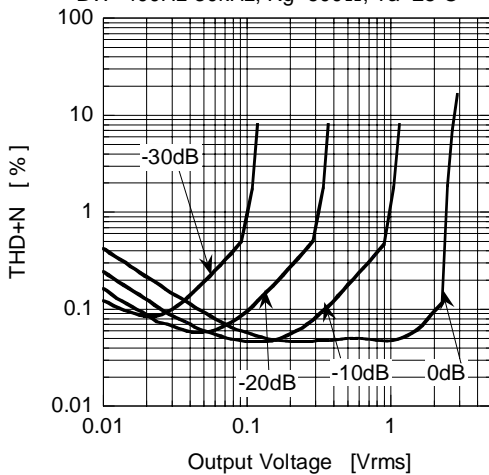

### THD+N vs Output Voltage

$V_{+}=9V$ ,  $V_{in}(Ach)$ ,  $f=1kHz$ ,  $V_{o}(Ach)OUTPUT$   
 $R_g=600\Omega$ ,  $BW=400Hz-30kHz$ ,  $V_{ol}=0dB$

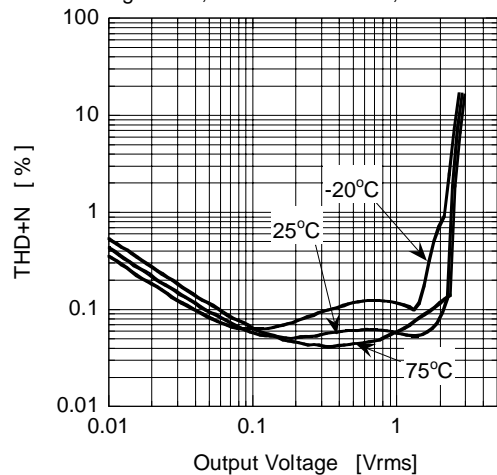

### MUTE Level vs Frequency

$V_{+}=9V$ ,  $V_{in}(Ach)=1V_{rms}$ ,  $V_{ol}=MUTE$   
 $V_{o}(Ach)OUTPUT$ ,  $R_g=600\Omega$ ,  $T_a=25^{\circ}C$

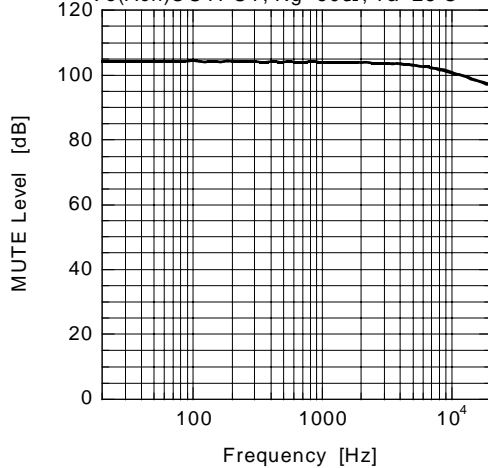

### Channel Separation vs Frequency

$V_{+}=9V$ ,  $V_{in}=1V_{rms}$ ,  $f=1kHz$ ,  $V_{o}=OUTPUT$   
 $R_g=600\Omega$ ,  $V_{ol}=0dB$ ,  $T_a=25^{\circ}C$

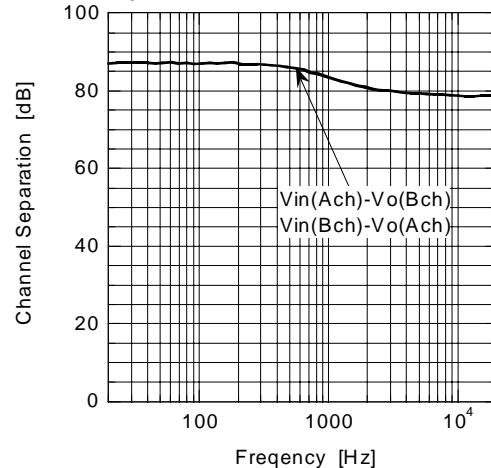

## TYPICAL CHARACTERISTICS

### Gain vs Frequency (TONE)

V+=9V, Vin(Ach+Bch)=0.1Vrms, Gv:3dB steps

Vo(Ach), Rg=600Ω, Ta=25°C

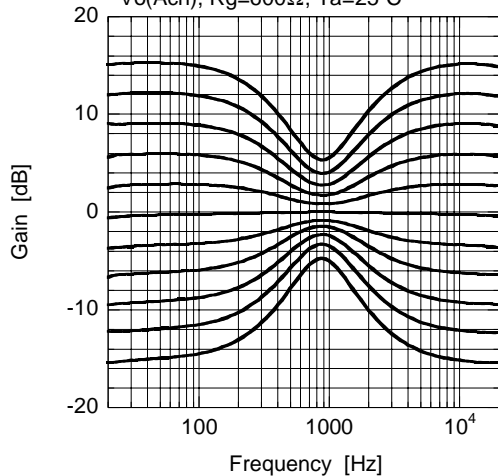

### AGC Control

V+=9V, Vin(Ach+Bch), f=1kHz, Vo(Ach)OUTPUT

Rg=600Ω, Ta=25°C

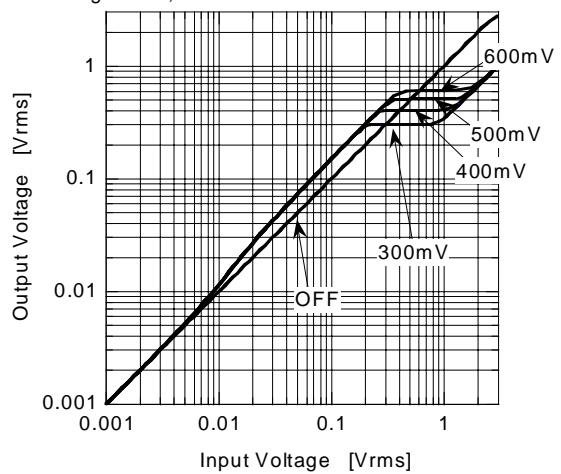

### AGC Attack Time (C:20pin=0.33μF)

V+=9V, Vin(Ach+Bch)=1Vrms, f=20kHz, Vo(Ach)OUTPUT

AGC level=0.3V, Rg=600Ω, Ta=25°C

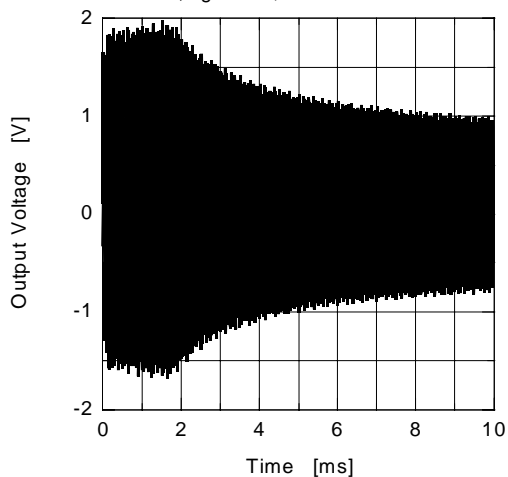

### AGC Recovery Time (C:20pin=0.33μF)

V+=9V, Vin(Ach+Bch)=1Vrms, f=10kHz, Vo(Ach)OUTPUT

AGC level=0.3V, Rg=600Ω, Ta=25°C

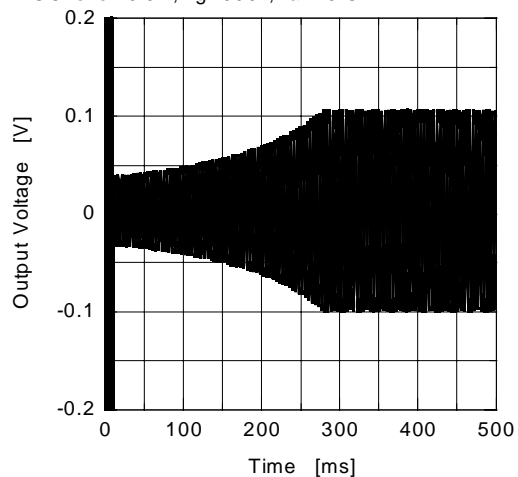

### Gain vs Frequency (eala&Simulated)

V+=9V, Vin=0.1Vrms, OUTPUT, Rg=600Ω,

Ta=25°C

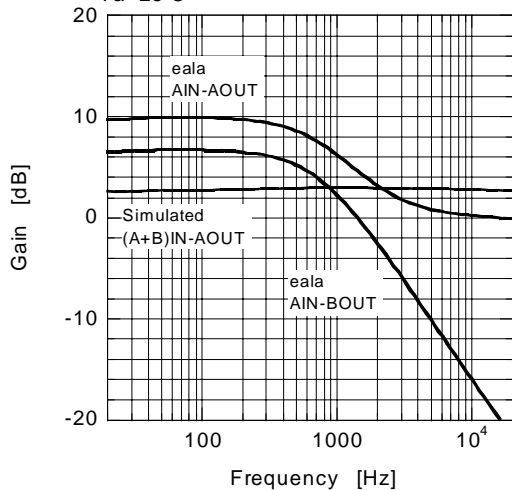

### Phase vs Frequency (Simulated)

V+=9V, Vin(A+Bch)=0.1Vrms, Rg=600Ω,

Ta=25°C

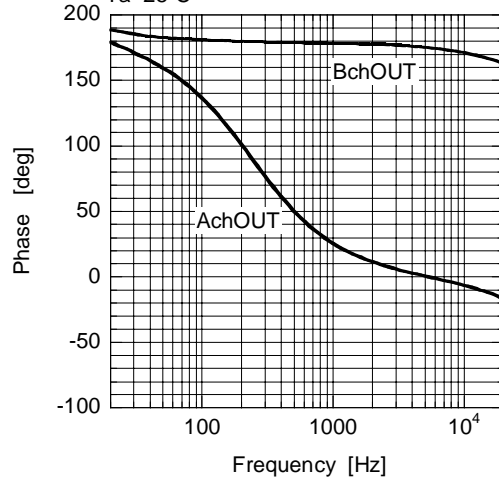

## ■ TYPICAL CHARACTERISTICS

### Gain vs Frequency (BBE)

$V_{+}=9V$ ,  $V_{in(Ach)}=0.1V_{rms}$ ,  $G_v=3dB$  steps  
 OUTPUT,  $R_g=60\Omega$ ,  $T_a=25^{\circ}C$

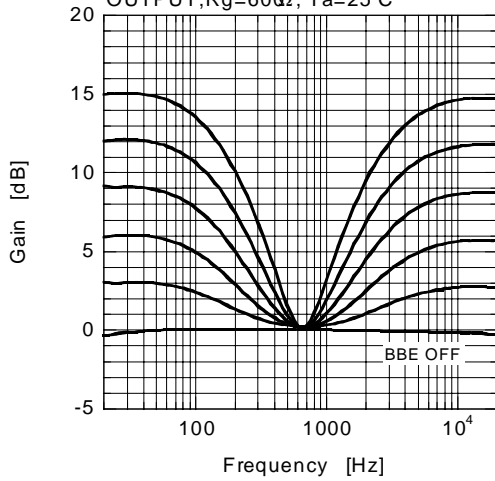

### Phase vs Frequency (BBE)

$V_{+}=9V$ ,  $V_{in(Ach)}=0.1V_{rms}$ ,  $V_{o(Ach)}$   
 $G_v=3dB$  steps,  $R_g=60\Omega$ ,  $T_a=25^{\circ}C$

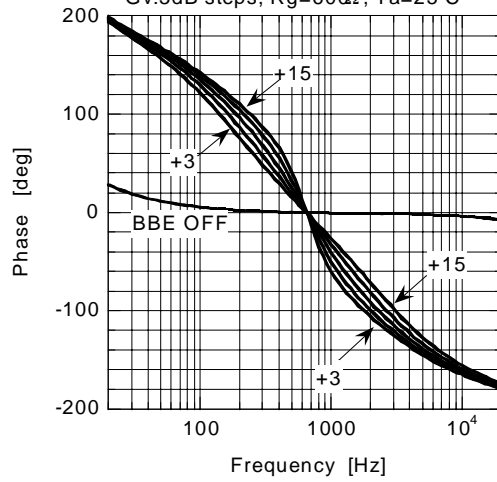

■ NOTE

1) The **NJW1145** is manufactured by New Japan Radio Co., Ltd. under license from BBE Sound Inc. BBE is a registered trademark of BBE Sound Inc. A license from BBE Sound Inc. must be required before the **NJW1145** can be purchased from New Japan Radio Co., Ltd.

BBE Sound, Inc.  
5381 Production Drive  
Huntington Beach, CA 92649 USA  
Tel: (714) 897-6766

Fax: (714) 896-0736

[CAUTION]

The specifications on this databook are only given for information, without any guarantee as regards either mistakes or omissions. The application circuits in this databook are described only to show representative usages of the product and not intended for the guarantee or permission of any right including the industrial rights.