

# MC33078 MC33079

## Dual/Quad Low Noise Operational Amplifiers

The MC33078/9 series is a family of high quality monolithic amplifiers employing Bipolar technology with innovative high performance concepts for quality audio and data signal processing applications. This family incorporates the use of high frequency PNP input transistors to produce amplifiers exhibiting low input voltage noise with high gain bandwidth product and slew rate. The all NPN output stage exhibits no deadband crossover distortion, large output voltage swing, excellent phase and gain margins, low open loop high frequency output impedance and symmetrical source and sink AC frequency performance.

The MC33078/9 family offers both dual and quad amplifier versions, tested over the automotive temperature range and available in the plastic DIP and SOIC packages (P and D suffixes).

- Dual Supply Operation:  $\pm 5.0\text{ V}$  to  $\pm 18\text{ V}$
- Low Voltage Noise:  $4.5\text{ nV}/\sqrt{\text{Hz}}$
- Low Input Offset Voltage:  $0.15\text{ mV}$
- Low T.C. of Input Offset Voltage:  $2.0\text{ }\mu\text{V}/^\circ\text{C}$
- Low Total Harmonic Distortion:  $0.002\%$
- High Gain Bandwidth Product:  $16\text{ MHz}$
- High Slew Rate:  $7.0\text{ V}/\mu\text{s}$
- High Open Loop AC Gain:  $800 @ 20\text{ kHz}$
- Excellent Frequency Stability
- Large Output Voltage Swing:  $+14.1\text{ V}/-14.6\text{ V}$
- ESD Diodes Provided on the Inputs

**Representative Schematic Diagram**  
(Each Amplifier)

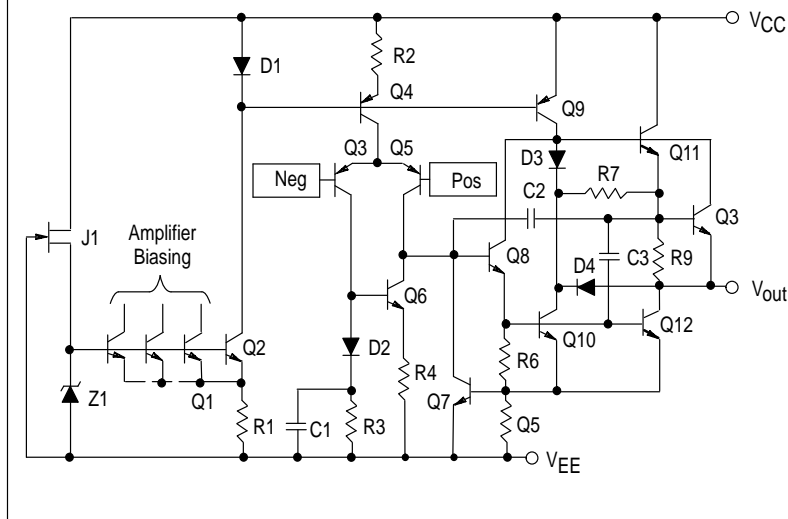

### DUAL/QUAD LOW NOISE OPERATIONAL AMPLIFIERS

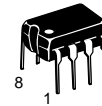

**DUAL**

**P SUFFIX**  
PLASTIC PACKAGE  
CASE 626



**D SUFFIX**  
PLASTIC PACKAGE  
CASE 751  
(SO-8)

#### PIN CONNECTIONS

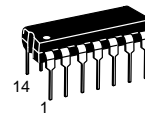
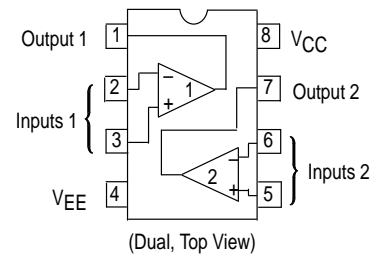

**QUAD**

**P SUFFIX**  
PLASTIC PACKAGE  
CASE 646

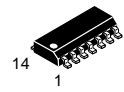

**D SUFFIX**  
PLASTIC PACKAGE  
CASE 751A  
(SO-14)

#### PIN CONNECTIONS

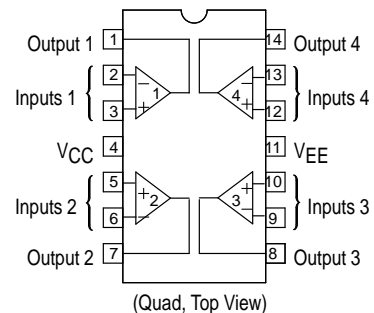

#### ORDERING INFORMATION

Device	Operating Temperature Range	Package
MC33078D MC33078P	$T_A = -40^\circ$ to $+85^\circ\text{C}$	SO-8 Plastic DIP
MC33079D MC33079P		SO-14 Plastic DIP

# MC33078 MC33079

## MAXIMUM RATINGS

Rating	Symbol	Value	Unit
Supply Voltage ( $V_{CC}$ to $V_{EE}$ )	$V_S$	+36	V
Input Differential Voltage Range	$V_{IDR}$	(Note 1)	V
Input Voltage Range	$V_{IR}$	(Note 1)	V
Output Short Circuit Duration (Note 2)	$t_{SC}$	Indefinite	sec
Maximum Junction Temperature	$T_J$	+150	°C
Storage Temperature	$T_{stg}$	-60 to +150	°C
Maximum Power Dissipation	$P_D$	(Note 2)	mW

- NOTES:** 1. Either or both input voltages must not exceed the magnitude of  $V_{CC}$  or  $V_{EE}$ .  
 2. Power dissipation must be considered to ensure maximum junction temperature ( $T_J$ ) is not exceeded (see Figure 1).

## DC ELECTRICAL CHARACTERISTICS ( $V_{CC} = +15$ V, $V_{EE} = -15$ V, $T_A = 25^\circ\text{C}$ , unless otherwise noted.)

Characteristics	Symbol	Min	Typ	Max	Unit
Input Offset Voltage ( $R_S = 10 \Omega$ , $V_{CM} = 0$ V, $V_O = 0$ V) (MC33078) $T_A = +25^\circ\text{C}$ $T_A = -40^\circ$ to $+85^\circ\text{C}$ (MC33079) $T_A = +25^\circ\text{C}$ $T_A = -40^\circ$ to $+85^\circ\text{C}$	$ V_{IO} $	—	0.15	2.0	mV
Average Temperature Coefficient of Input Offset Voltage $R_S = 10 \Omega$ , $V_{CM} = 0$ V, $V_O = 0$ V, $T_A = T_{low}$ to $T_{high}$	$\Delta V_{IO}/\Delta T$	—	2.0	—	$\mu\text{V}/^\circ\text{C}$
Input Bias Current ( $V_{CM} = 0$ V, $V_O = 0$ V) $T_A = +25^\circ\text{C}$ $T_A = -40^\circ$ to $+85^\circ\text{C}$	$I_{IB}$	—	300	750	nA
Input Offset Current ( $V_{CM} = 0$ V, $V_O = 0$ V) $T_A = +25^\circ\text{C}$ $T_A = -40^\circ$ to $+85^\circ\text{C}$	$I_{IO}$	—	25	150	nA
Common Mode Input Voltage Range ( $\Delta V_{IO} = 5.0$ mV, $V_O = 0$ V)	$V_{ICR}$	$\pm 13$	$\pm 14$	—	V
Large Signal Voltage Gain ( $V_O = \pm 10$ V, $R_L = 2.0$ k $\Omega$ ) $T_A = +25^\circ\text{C}$ $T_A = -40^\circ$ to $+85^\circ\text{C}$	$A_{VOL}$	90	110	—	dB
Output Voltage Swing ( $V_{ID} = \pm 1.0$ V) $R_L = 600 \Omega$ $R_L = 600 \Omega$ $R_L = 2.0$ k $\Omega$ $R_L = 2.0$ k $\Omega$ $R_L = 10$ k $\Omega$ $R_L = 10$ k $\Omega$	$V_{O+}$ $V_{O-}$ $V_{O+}$ $V_{O-}$ $V_{O+}$ $V_{O-}$	— — +13.2 — +13.5 —	+10.7 -11.9 +13.8 -13.7 +14.1 -14.6	— — — -13.2 — -14	V
Common Mode Rejection ( $V_{in} = \pm 13$ V)	CMR	80	100	—	dB
Power Supply Rejection (Note 3) $V_{CC}/V_{EE} = +15$ V / $-15$ V to $+5.0$ V / $-5.0$ V	PSR	80	105	—	dB
Output Short Circuit Current ( $V_{ID} = 1.0$ V, Output to Ground) Source Sink	$I_{SC}$	+15 -20	+29 -37	— —	mA
Power Supply Current ( $V_O = 0$ V, All Amplifiers) (MC33078) $T_A = +25^\circ\text{C}$ $T_A = -40^\circ$ to $+85^\circ\text{C}$ (MC33079) $T_A = +25^\circ\text{C}$ $T_A = -40^\circ$ to $+85^\circ\text{C}$	$I_D$	— — — —	4.1 — 8.4 —	5.0 5.5 10 11	mA

- NOTE:** 3. Measured with  $V_{CC}$  and  $V_{EE}$  differentially varied simultaneously.

# MC33078 MC33079

**AC ELECTRICAL CHARACTERISTICS** ( $V_{CC} = +15\text{ V}$ ,  $V_{EE} = -15\text{ V}$ ,  $T_A = 25^\circ\text{C}$ , unless otherwise noted.)

Characteristics	Symbol	Min	Typ	Max	Unit	
Slew Rate ( $V_{in} = -10\text{ V}$ to $+10\text{ V}$ , $R_L = 2.0\text{ k}\Omega$ , $C_L = 100\text{ pF}$ , $A_V = +1.0$ )	SR	5.0	7.0	—	V/ $\mu\text{s}$	
Gain Bandwidth Product ( $f = 100\text{ kHz}$ )	GBW	10	16	—	MHz	
Unity Gain Frequency (Open Loop)	$f_U$	—	9.0	—	MHz	
Gain Margin ( $R_L = 2.0\text{ k}\Omega$ )	$A_m$	$C_L = 0\text{ pF}$	—	-11	—	dB
		$C_L = 100\text{ pF}$	—	-6.0	—	
Phase Margin ( $R_L = 2.0\text{ k}\Omega$ )	$\phi_m$	$C_L = 0\text{ pF}$	—	55	—	Degrees
		$C_L = 100\text{ pF}$	—	40	—	
Channel Separation ( $f = 20\text{ Hz}$ to $20\text{ kHz}$ )	CS	—	-120	—	dB	
Power Bandwidth ( $V_O = 27\text{ V}_{pp}$ , $R_L = 2.0\text{ k}\Omega$ , $\text{THD} \leq 1.0\%$ )	$BW_p$	—	120	—	kHz	
Distortion ( $R_L = 2.0\text{ k}\Omega$ , $f = 20\text{ Hz}$ to $20\text{ kHz}$ , $V_O = 3.0\text{ V}_{rms}$ , $A_V = +1.0$ )	THD	—	0.002	—	%	
Open Loop Output Impedance ( $V_O = 0\text{ V}$ , $f = 9.0\text{ MHz}$ )	$ Z_O $	—	37	—	$\Omega$	
Differential Input Resistance ( $V_{CM} = 0\text{ V}$ )	$R_{IN}$	—	175	—	$\text{k}\Omega$	
Differential Input Capacitance ( $V_{CM} = 0\text{ V}$ )	$C_{IN}$	—	12	—	pF	
Equivalent Input Noise Voltage ( $R_S = 100\ \Omega$ , $f = 1.0\text{ kHz}$ )	$e_n$	—	4.5	—	$\text{nV}/\sqrt{\text{Hz}}$	
Equivalent Input Noise Current ( $f = 1.0\text{ kHz}$ )	$i_n$	—	0.5	—	$\text{pA}/\sqrt{\text{Hz}}$	

**Figure 1. Maximum Power Dissipation versus Temperature**

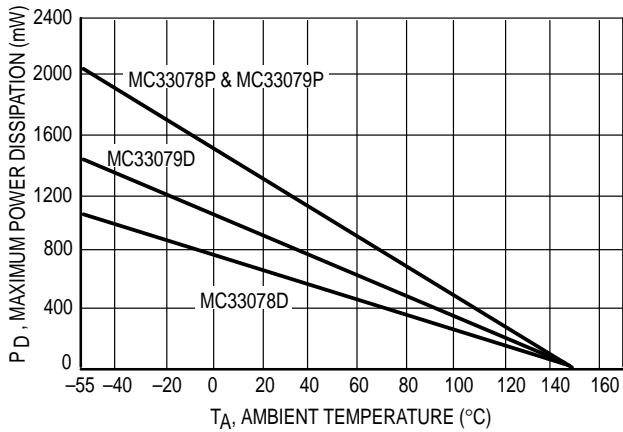

**Figure 2. Input Bias Current versus Supply Voltage**

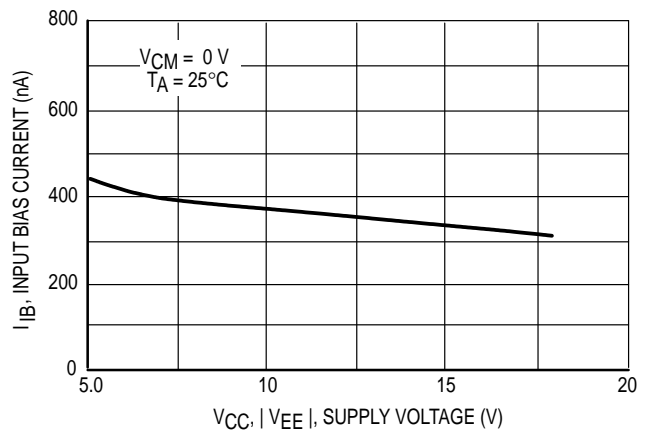

**Figure 3. Input Bias Current versus Temperature**

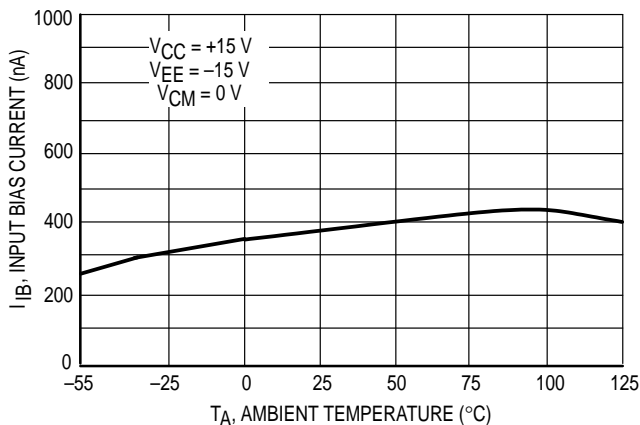

**Figure 4. Input Offset Voltage versus Temperature**

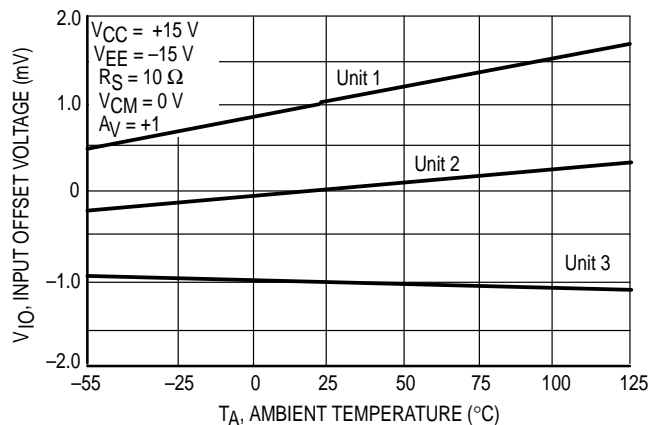

Figure 5. Input Bias Current versus Common Mode Voltage

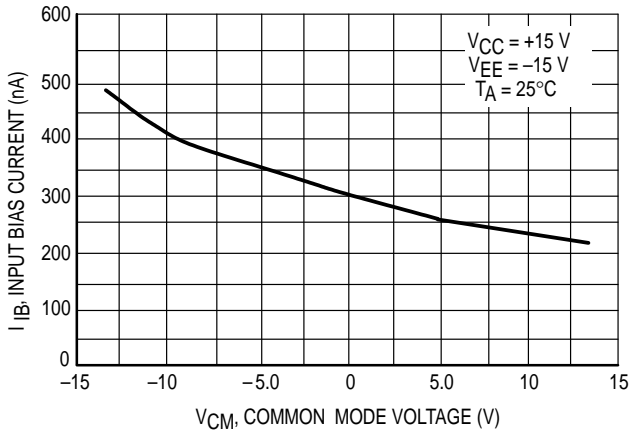

Figure 6. Input Common Mode Voltage Range versus Temperature

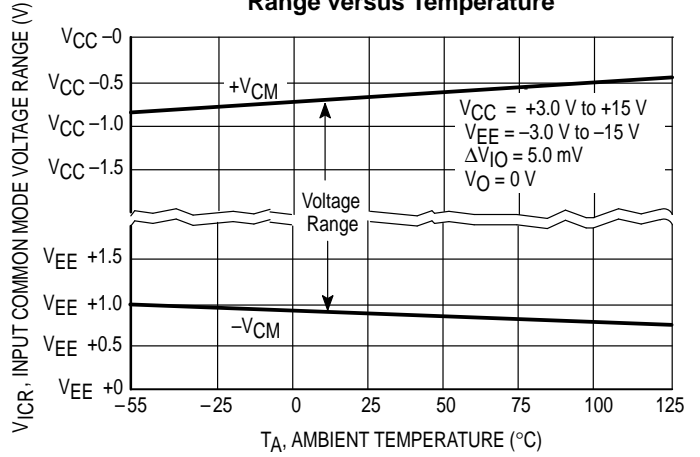

Figure 7. Output Saturation Voltage versus Load Resistance to Ground

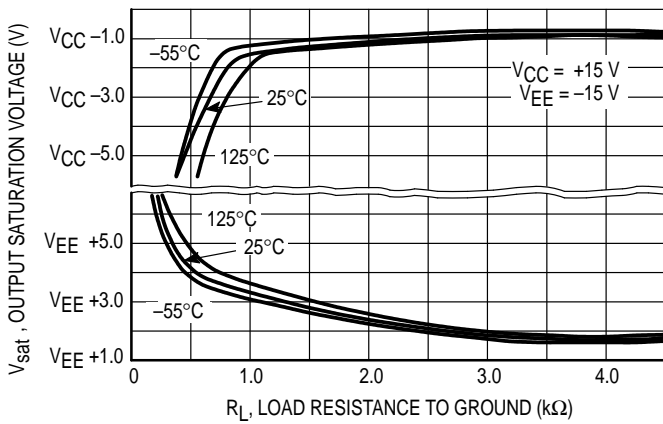

Figure 8. Output Short Circuit Current versus Temperature

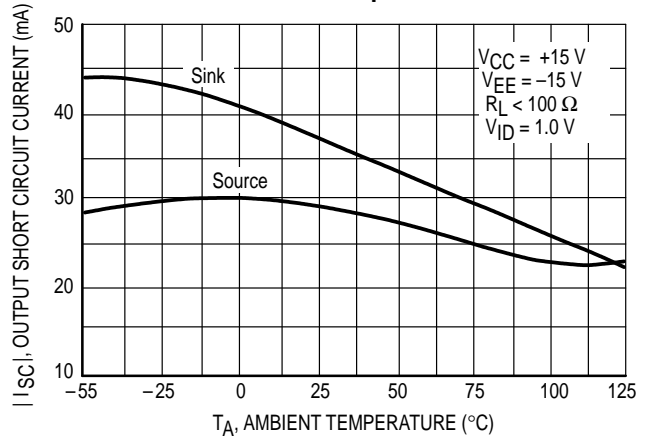

Figure 9. Supply Current versus Temperature

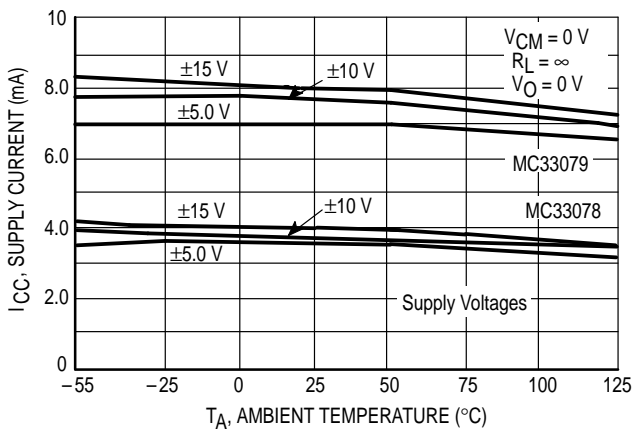

Figure 10. Common Mode Rejection versus Frequency

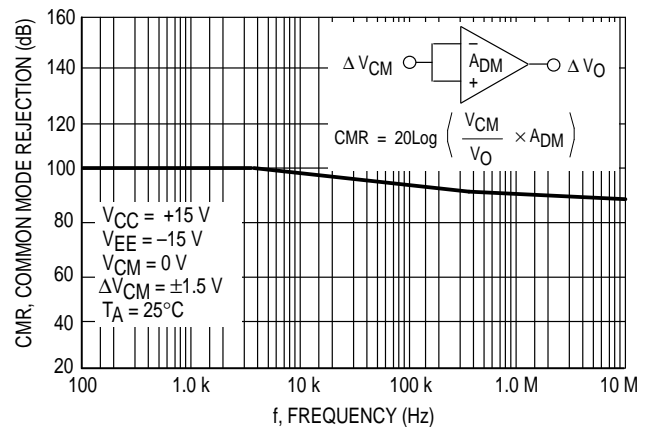

Figure 11. Power Supply Rejection versus Frequency

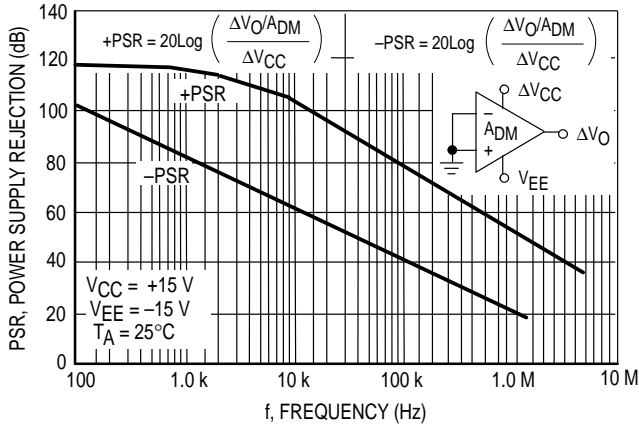

Figure 12. Gain Bandwidth Product versus Supply Voltage

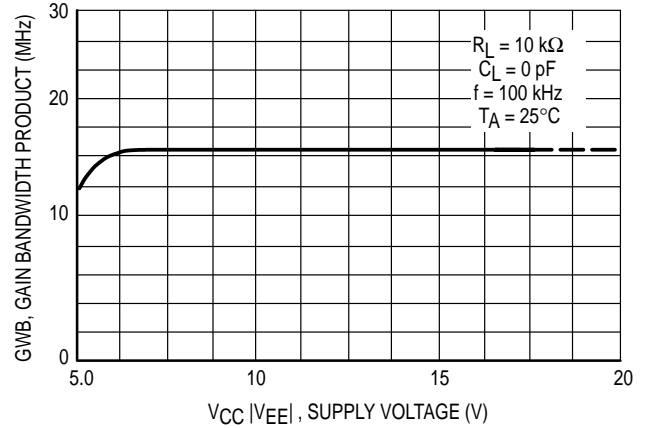

Figure 13. Gain Bandwidth Product versus Temperature

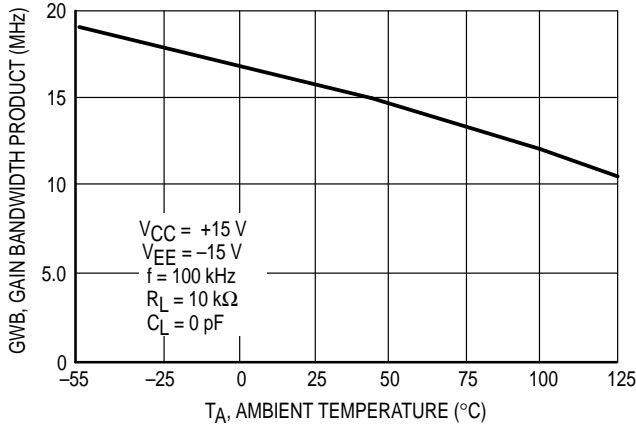

Figure 14. Maximum Output Voltage versus Supply Voltage

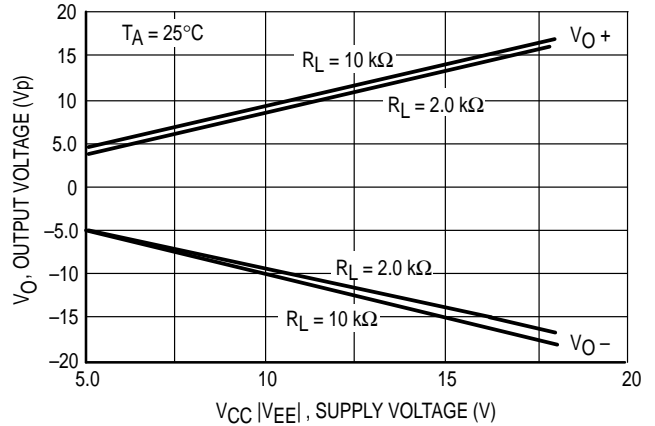

Figure 15. Output Voltage versus Frequency

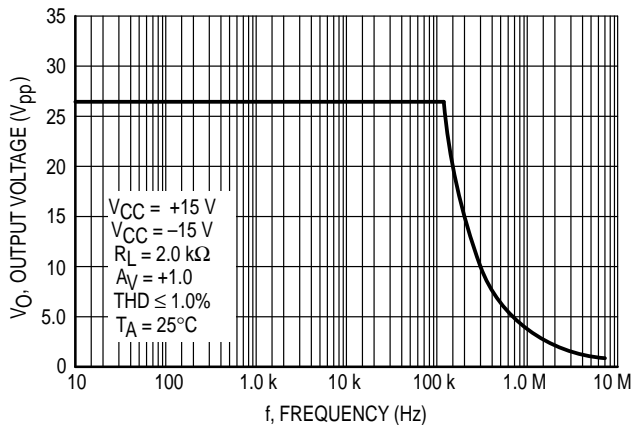

Figure 16. Open Loop Voltage Gain versus Supply Voltage

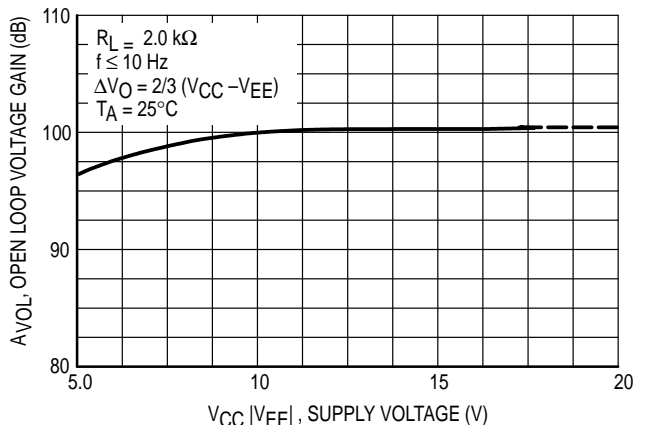

Figure 17. Open Loop Voltage Gain versus Temperature

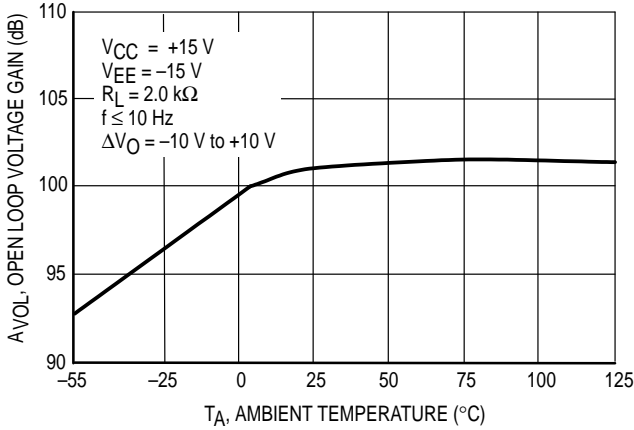

Figure 18. Output Impedance versus Frequency

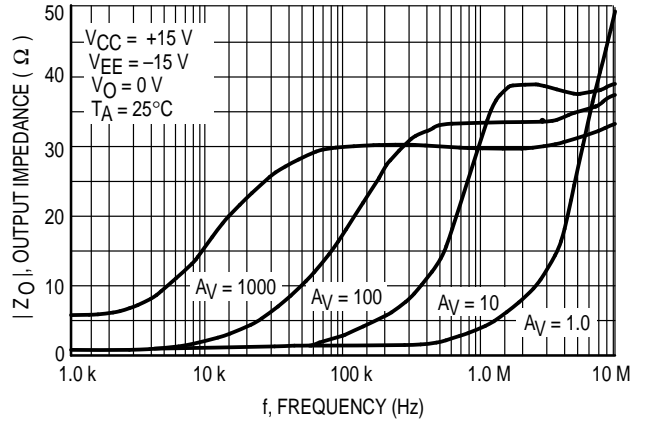

Figure 19. Channel Separation versus Frequency

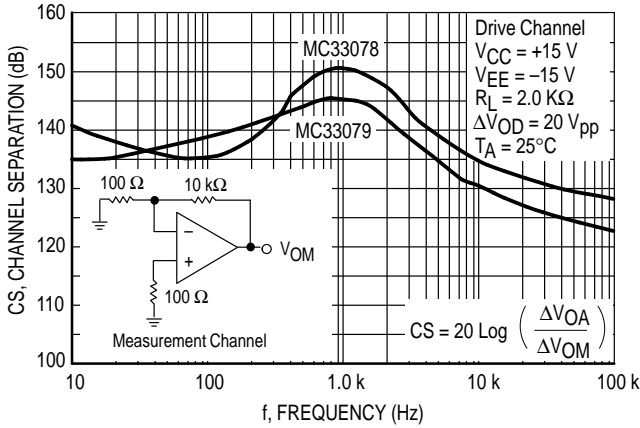

Figure 20. Total Harmonic Distortion versus Frequency

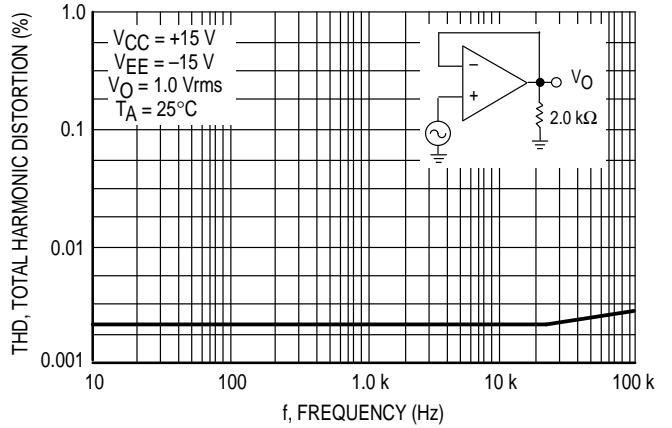

Figure 21. Total Harmonic Distortion versus Output Voltage

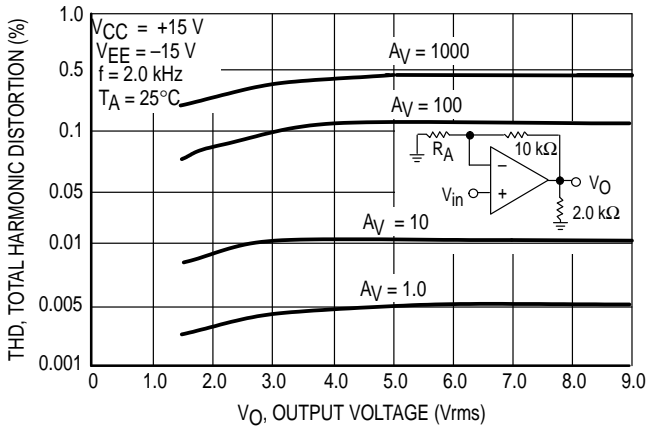

Figure 22. Slew Rate versus Supply Voltage

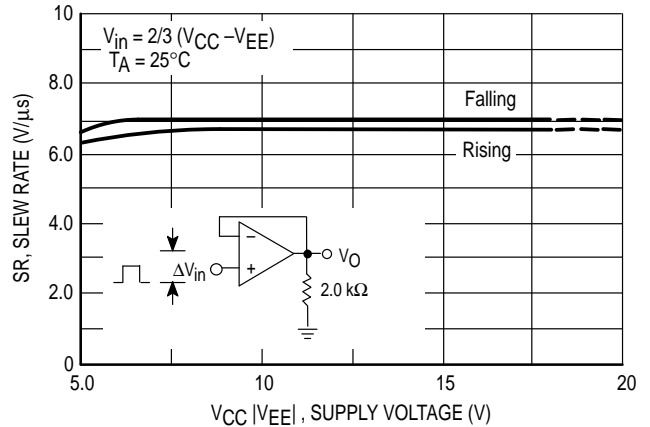

Figure 23. Slew Rate versus Temperature

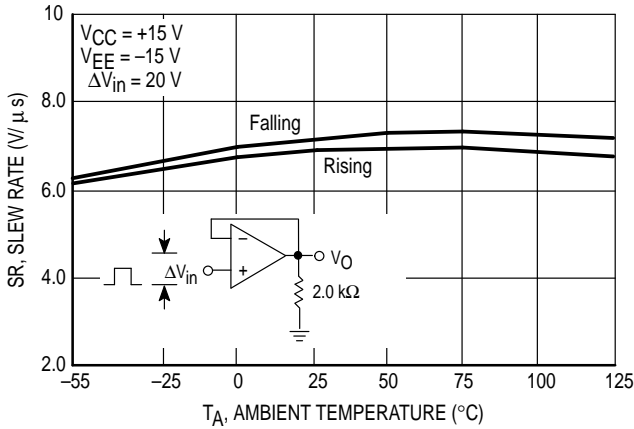

Figure 24. Voltage Gain and Phase versus Frequency

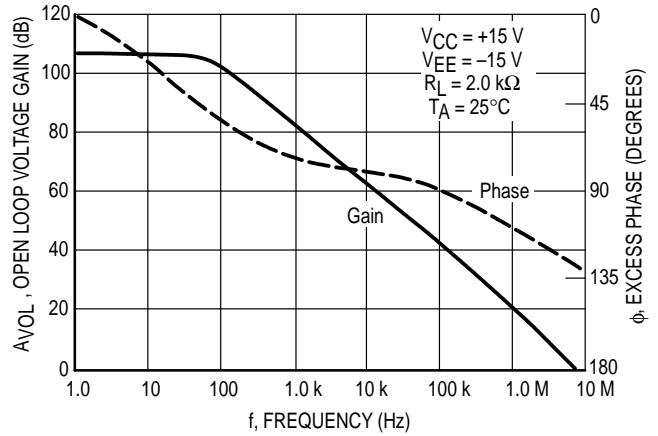

Figure 25. Open Loop Gain Margin and Phase Margin versus Load Capacitance

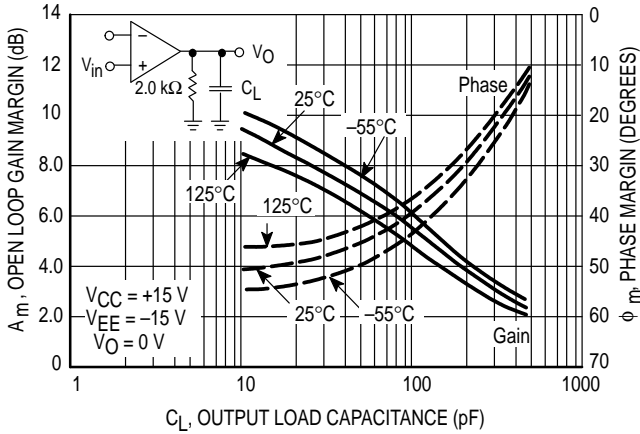

Figure 26. Overshoot versus Output Load Capacitance

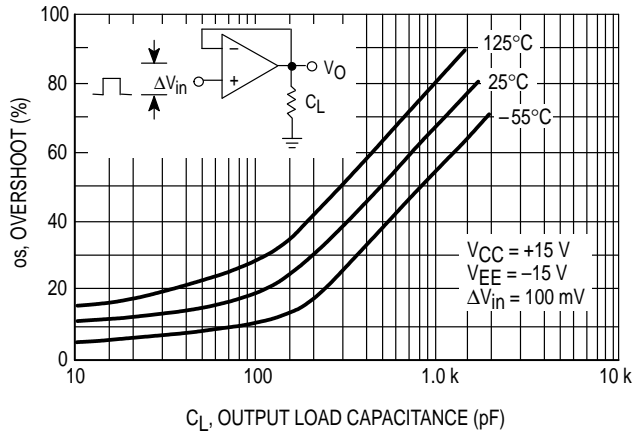

Figure 27. Input Referred Noise Voltage and Current versus Frequency

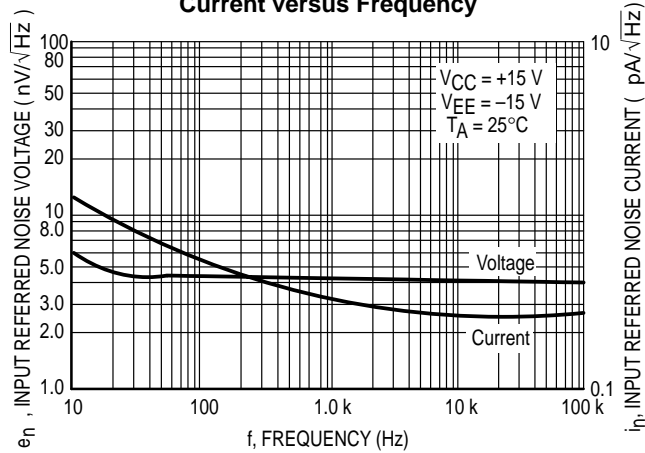

Figure 28. Total Input Referred Noise Voltage versus Source Resistance

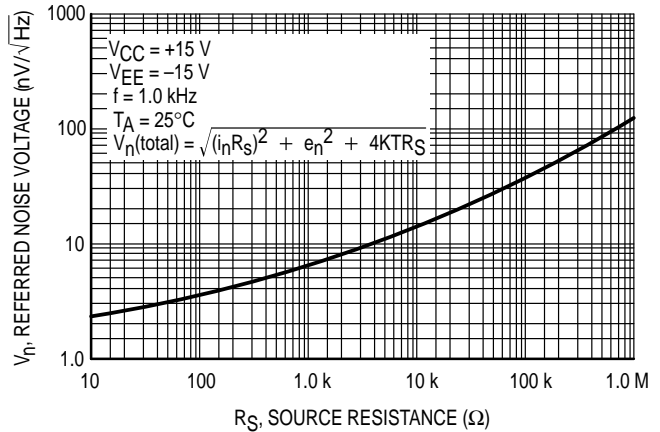

Figure 29. Phase Margin and Gain Margin versus Differential Source Resistance

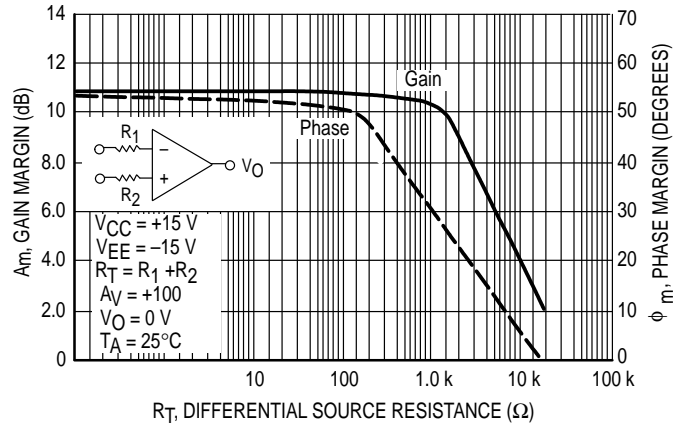

Figure 30. Inverting Amplifier Slew Rate

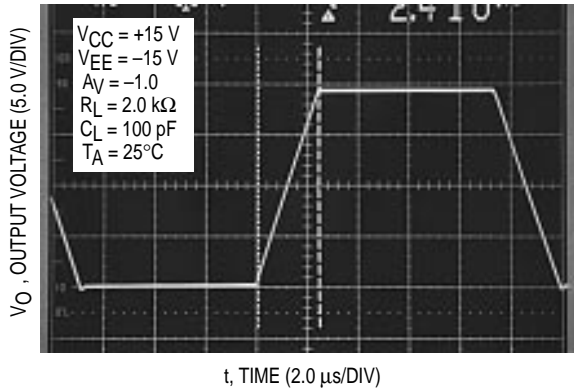

Figure 31. Noninverting Amplifier Slew Rate

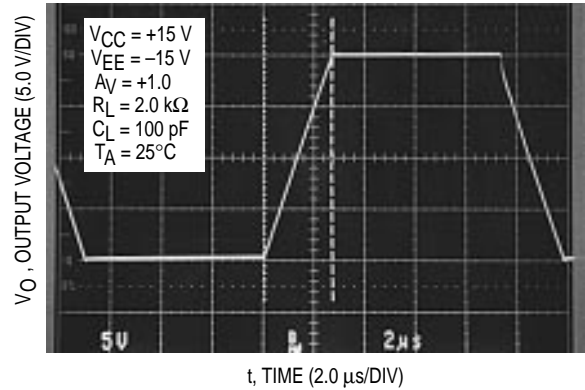

Figure 32. Noninverting Amplifier Overshoot

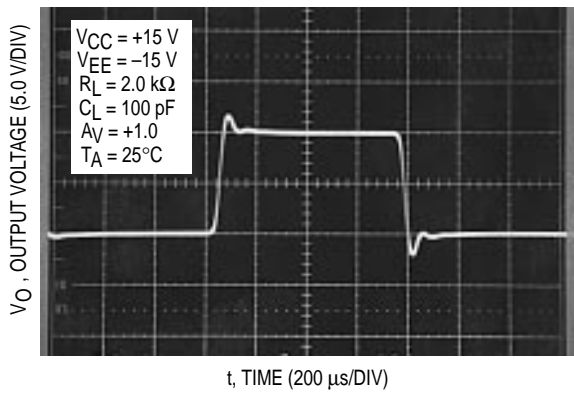
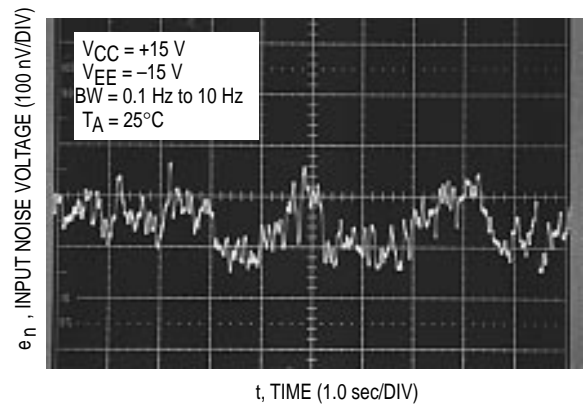

Figure 33. Low Frequency Noise Voltage versus Time





# MC33078 MC33079

Figure 34. Voltage Noise Test Circuit  
(0.1 Hz to 10 Hz<sub>p-p</sub>)

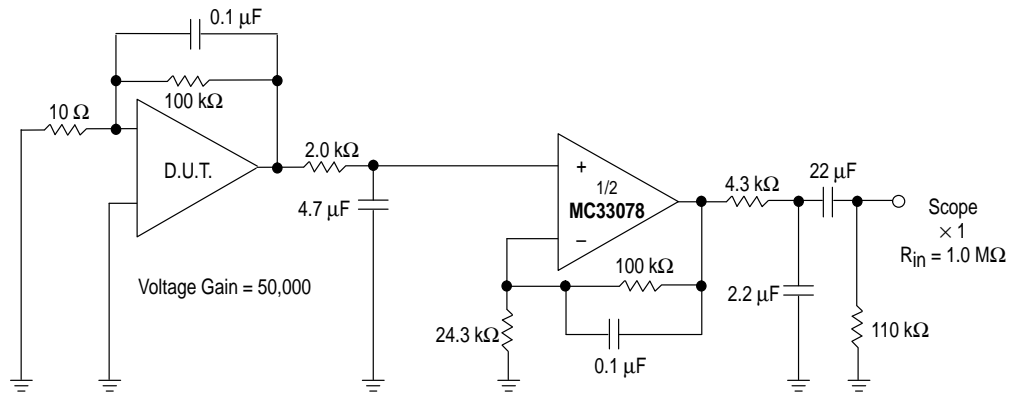

Note: All capacitors are non-polarized.

# MC33078 MC33079

## OUTLINE DIMENSIONS

### P SUFFIX PLASTIC PACKAGE CASE 626-05 ISSUE K

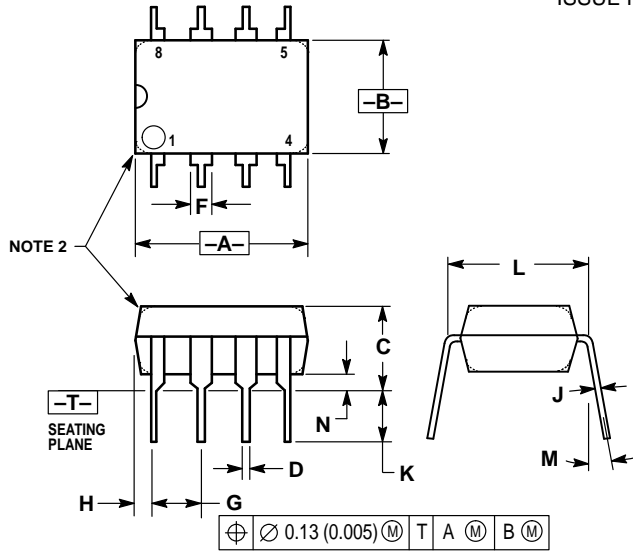

NOTES:

1. DIMENSION L TO CENTER OF LEAD WHEN FORMED PARALLEL.
2. PACKAGE CONTOUR OPTIONAL (ROUND OR SQUARE CORNERS).
3. DIMENSIONING AND TOLERANCING PER ANSI Y14.5M, 1982.

DIM	MILLIMETERS		INCHES	
	MIN	MAX	MIN	MAX
A	9.40	10.16	0.370	0.400
B	6.10	6.60	0.240	0.260
C	3.94	4.45	0.155	0.175
D	0.38	0.51	0.015	0.020
F	1.02	1.78	0.040	0.070
G	2.54 BSC		0.100 BSC	
H	0.76	1.27	0.030	0.050
J	0.20	0.30	0.008	0.012
K	2.92	3.43	0.115	0.135
L	7.62 BSC		0.300 BSC	
M	—		10°	
N	0.76	1.01	0.030	0.040

### D SUFFIX PLASTIC PACKAGE CASE 751-05 (SO-8) ISSUE R

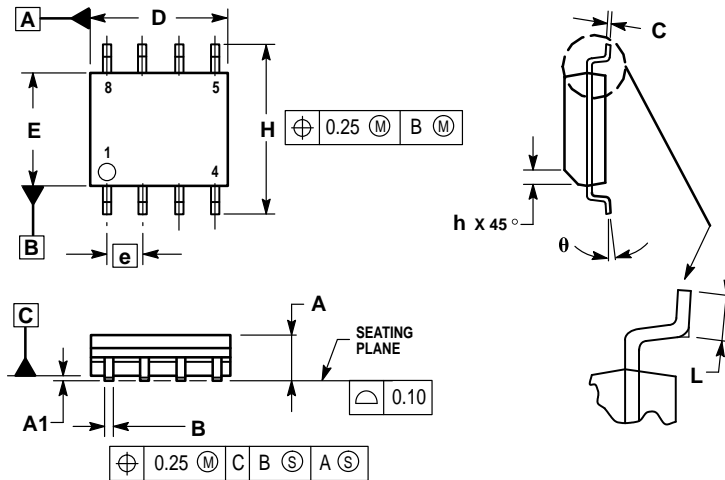

NOTES:

1. DIMENSIONING AND TOLERANCING PER ASME Y14.5M, 1994.
2. DIMENSIONS ARE IN MILLIMETERS.
3. DIMENSION D AND E DO NOT INCLUDE MOLD PROTRUSION.
4. MAXIMUM MOLD PROTRUSION 0.15 PER SIDE.
5. DIMENSION B DOES NOT INCLUDE MOLD PROTRUSION. ALLOWABLE DAMBAR PROTRUSION SHALL BE 0.127 TOTAL IN EXCESS OF THE B DIMENSION AT MAXIMUM MATERIAL CONDITION.

DIM	MILLIMETERS	
	MIN	MAX
A	1.35	1.75
A1	0.10	0.25
B	0.35	0.49
C	0.18	0.25
D	4.80	5.00
E	3.80	4.00
e	1.27 BSC	
H	5.80	6.20
h	0.25	0.50
L	0.40	1.25
θ	0° 7°	

# MC33078 MC33079

## OUTLINE DIMENSIONS

### P SUFFIX PLASTIC PACKAGE CASE 646-06 ISSUE L

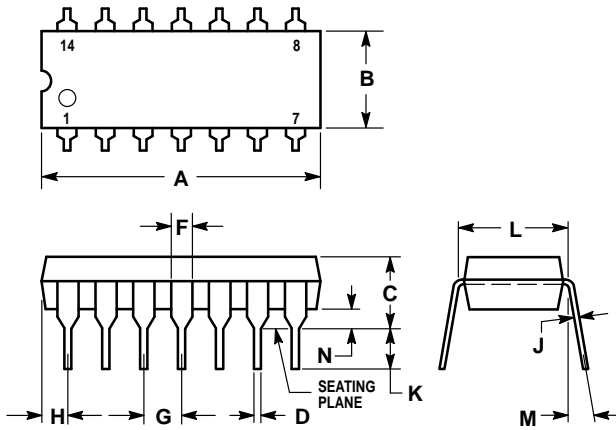

NOTES:

- LEADS WITHIN 0.13 (0.005) RADIUS OF TRUE POSITION AT SEATING PLANE AT MAXIMUM MATERIAL CONDITION.
- DIMENSION L TO CENTER OF LEADS WHEN FORMED PARALLEL.
- DIMENSION B DOES NOT INCLUDE MOLD FLASH.
- ROUNDED CORNERS OPTIONAL.

DIM	INCHES		MILLIMETERS	
	MIN	MAX	MIN	MAX
A	0.715	0.770	18.16	19.56
B	0.240	0.260	6.10	6.60
C	0.145	0.185	3.69	4.69
D	0.015	0.021	0.38	0.53
F	0.040	0.070	1.02	1.78
G	0.100 BSC		2.54 BSC	
H	0.052	0.095	1.32	2.41
J	0.008	0.015	0.20	0.38
K	0.115	0.135	2.92	3.43
L	0.300 BSC		7.62 BSC	
M	0°	10°	0°	10°
N	0.015	0.039	0.39	1.01

### D SUFFIX PLASTIC PACKAGE CASE 751A-03 (SO-14) ISSUE F

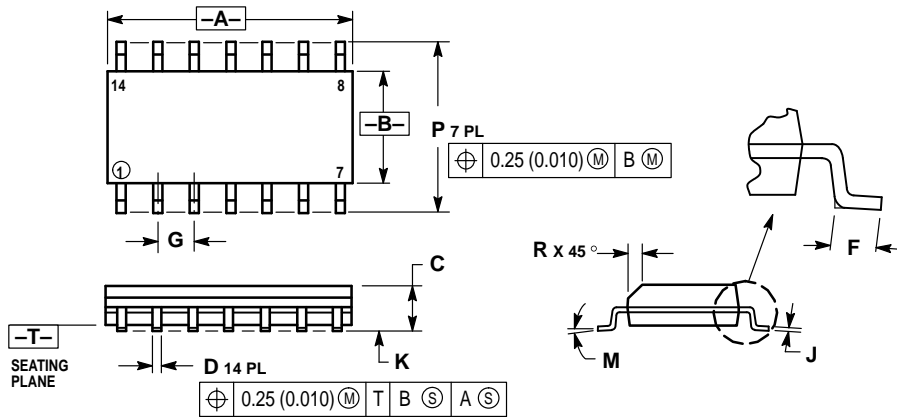

NOTES:

- DIMENSIONING AND TOLERANCING PER ANSI Y14.5M, 1982.
- CONTROLLING DIMENSION: MILLIMETER.
- DIMENSIONS A AND B DO NOT INCLUDE MOLD PROTRUSION.
- MAXIMUM MOLD PROTRUSION 0.15 (0.006) PER SIDE.
- DIMENSION D DOES NOT INCLUDE DAMBAR PROTRUSION. ALLOWABLE DAMBAR PROTRUSION SHALL BE 0.127 (0.005) TOTAL IN EXCESS OF THE D DIMENSION AT MAXIMUM MATERIAL CONDITION.

DIM	MILLIMETERS		INCHES	
	MIN	MAX	MIN	MAX
A	8.55	8.75	0.337	0.344
B	3.80	4.00	0.150	0.157
C	1.35	1.75	0.054	0.068
D	0.35	0.49	0.014	0.019
F	0.40	1.25	0.016	0.049
G	1.27 BSC		0.050 BSC	
J	0.19	0.25	0.008	0.009
K	0.10	0.25	0.004	0.009
M	0°	7°	0°	7°
P	5.80	6.20	0.228	0.244
R	0.25	0.50	0.010	0.019

Motorola reserves the right to make changes without further notice to any products herein. Motorola makes no warranty, representation or guarantee regarding the suitability of its products for any particular purpose, nor does Motorola assume any liability arising out of the application or use of any product or circuit, and specifically disclaims any and all liability, including without limitation consequential or incidental damages. "Typical" parameters which may be provided in Motorola data sheets and/or specifications can and do vary in different applications and actual performance may vary over time. All operating parameters, including "Typicals" must be validated for each customer application by customer's technical experts. Motorola does not convey any license under its patent rights nor the rights of others. Motorola products are not designed, intended, or authorized for use as components in systems intended for surgical implant into the body, or other applications intended to support or sustain life, or for any other application in which the failure of the Motorola product could create a situation where personal injury or death may occur. Should Buyer purchase or use Motorola products for any such unintended or unauthorized application, Buyer shall indemnify and hold Motorola and its officers, employees, subsidiaries, affiliates, and distributors harmless against all claims, costs, damages, and expenses, and reasonable attorney fees arising out of, directly or indirectly, any claim of personal injury or death associated with such unintended or unauthorized use, even if such claim alleges that Motorola was negligent regarding the design or manufacture of the part. Motorola and  are registered trademarks of Motorola, Inc. Motorola, Inc. is an Equal Opportunity/Affirmative Action Employer.

**How to reach us:**

**USA/EUROPE/Locations Not Listed:** Motorola Literature Distribution;  
P.O. Box 20912; Phoenix, Arizona 85036. 1-800-441-2447 or 602-303-5454

**JAPAN:** Nippon Motorola Ltd.; Tatsumi-SPD-JLDC, 6F Seibu-Butsuryu-Center,  
3-14-2 Tatsumi Koto-Ku, Tokyo 135, Japan. 03-81-3521-8315

**MFAX:** RMFAX0@email.sps.mot.com – TOUCHTONE 602-244-6609  
**INTERNET:** <http://Design-NET.com>

**ASIA/PACIFIC:** Motorola Semiconductors H.K. Ltd.; 8B Tai Ping Industrial Park,  
51 Ting Kok Road, Tai Po, N.T., Hong Kong. 852-26629298

