



5th-Order, Lowpass, Switched-Capacitor Filters

MAX7409/MAX7410/MAX7413/MAX7414

General Description

The MAX7409/MAX7410/MAX7413/MAX7414 5th-order, lowpass, switched-capacitor filters (SCFs) operate from a single +5V (MAX7409/MAX7410) or +3V (MAX7413/MAX7414) supply. These devices draw only 1.2mA of supply current and allow corner frequencies from 1Hz to 15kHz, making them ideal for low-power post-DAC filtering and anti-aliasing applications. They feature a shutdown mode, which reduces the supply current to 0.2µA.

Two clocking options are available on these devices: self-clocking (through the use of an external capacitor) or external clocking for tighter corner-frequency control. An offset adjust pin allows for adjustment of the DC output level.

The MAX7409/MAX7413 Bessel filters provide low overshoot and fast settling, while the MAX7410/MAX7414 Butterworth filters provide a maximally flat passband response. Their fixed response simplifies the design task to selecting a clock frequency.

Applications

- ADC Anti-Aliasing
- CT2 Base Stations
- DAC Postfiltering
- Speech Processing
- Air-Bag Electronics

Selector Guide

PART	FILTER RESPONSE	OPERATING VOLTAGE (V)
MAX7409	Bessel	+5
MAX7410	Butterworth	+5
MAX7413	Bessel	+3
MAX7414	Butterworth	+3

Pin Configuration

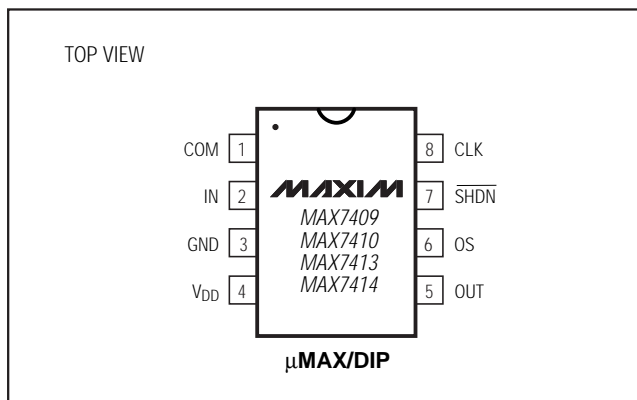

Features

- ◆ **5th-Order Lowpass Filters**
 Bessel Response (MAX7409/MAX7413)
 Butterworth Response (MAX7410/MAX7414)
- ◆ **Clock-Tunable Corner Frequency (1Hz to 15kHz)**
- ◆ **Single-Supply Operation**
 +5V (MAX7409/MAX7410)
 +3V (MAX7413/MAX7414)
- ◆ **Low Power**
 1.2mA (operating mode)
 0.2µA (shutdown mode)
- ◆ **Available in 8-Pin µMAX/DIP Packages**
- ◆ **Low Output Offset: ±4mV**

Ordering Information

PART	TEMP. RANGE	PIN-PACKAGE
MAX7409CUA	0°C to +70°C	8 µMAX
MAX7409CPA	0°C to +70°C	8 Plastic DIP
MAX7409EUA	-40°C to +85°C	8 µMAX
MAX7409EPA	-40°C to +85°C	8 Plastic DIP
MAX7410CUA	0°C to +70°C	8 µMAX
MAX7410CPA	0°C to +70°C	8 Plastic DIP
MAX7410EUA	-40°C to +85°C	8 µMAX
MAX7410EPA	-40°C to +85°C	8 Plastic DIP

Ordering Information continued at end of data sheet.

Typical Operating Circuit

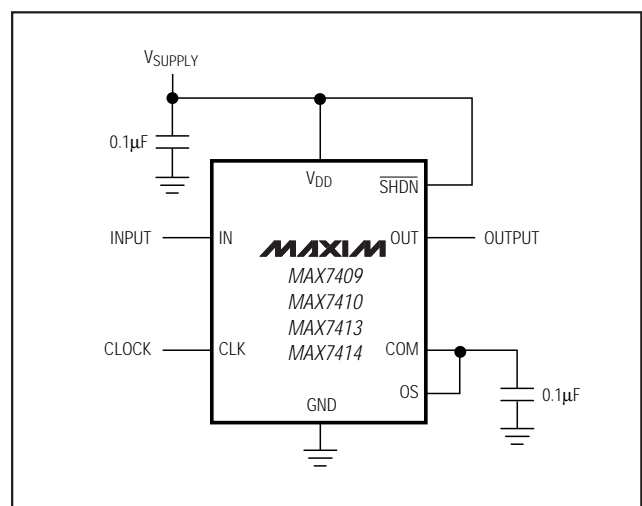

5th-Order, Lowpass, Switched-Capacitor Filters

ABSOLUTE MAXIMUM RATINGS

V _{DD} to GND	-0.3V to +6V
IN, OUT, COM, OS, CLK, SHDN	-0.3V to (V _{DD} + 0.3V)
OUT Short-Circuit Duration	1sec
Continuous Power Dissipation (T _A = +70°C)	
8-Pin DIP (derate 9.09mW/°C above +70°C)	727mW
8-Pin μMAX (derate 4.1mW/°C above +70°C)	330mW

Operating Temperature Ranges

MAX74 _ _C_A	0°C to +70°C
MAX74 _ _E_A	-40°C to +85°C
Storage Temperature Range	-65°C to +160°C
Lead Temperature (soldering, 10sec)	+300°C

Stresses beyond those listed under "Absolute Maximum Ratings" may cause permanent damage to the device. These are stress ratings only, and functional operation of the device at these or any other conditions beyond those indicated in the operational sections of the specifications is not implied. Exposure to absolute maximum rating conditions for extended periods may affect device reliability.

ELECTRICAL CHARACTERISTICS—MAX7409/MAX7410

(V_{DD} = +5V, filter output measured at OUT, 10kΩ || 50pF load to GND at OUT, OS = COM, 0.1μF capacitor from COM to GND, SHDN = V_{DD}, f_{CLK} = 100kHz, T_A = T_{MIN} to T_{MAX}, unless otherwise noted. Typical values are at T_A = +25°C.)

PARAMETER	SYMBOL	CONDITIONS	MIN	TYP	MAX	UNITS
FILTER CHARACTERISTICS						
Corner Frequency	f _c	(Note 1)	0.001 to 15			kHz
Clock-to-Corner Ratio	f _{CLK} / f _c		100:1			
Clock-to-Corner Tempco			10			ppm/°C
Output Voltage Range			0.25	V _{DD} - 0.25		V
Output Offset Voltage	V _{OFFSET}	V _{IN} = V _{COM} = V _{DD} / 2	±4		±25	mV
DC Insertion Gain with Output Offset Removed		V _{COM} = V _{DD} / 2 (Note 2)	-0.2	0	0.2	dB
Total Harmonic Distortion plus Noise	THD+N	f _{IN} = 200Hz, V _{IN} = 4Vp-p, measurement bandwidth = 22kHz	MAX7409		-85	dB
			MAX7410		-78	
Offset Voltage Gain	A _{OS}	OS to OUT	1			V/V
COM Voltage Range	V _{COM}	Input, COM externally driven	2.0	2.5	3.0	V
		Output, COM unconnected	2.3	2.5	2.7	
Input Voltage Range at OS	V _{OS}	Input, OS externally driven	V _{COM} ±0.1			V
Input Resistance at COM	R _{COM}		110	180		kΩ
Clock Feedthrough			5			mVp-p
Resistive Output Load Drive	R _L		10	1		kΩ
Maximum Capacitive Output Load Drive	C _L		50	500		pF
Input Leakage Current at COM		SHDN = GND, V _{COM} = 0 to V _{DD}	±0.1		±10	μA
Input Leakage Current at OS		V _{OS} = 0 to V _{DD}	±0.1		±10	μA
CLOCK						
Internal Oscillator Frequency	f _{OSC}	C _{OSC} = 1000pF (Note 3)	21	30	38	kHz
Clock Output Current (Internal Oscillator Mode)	I _{CLK}	V _{CLK} = 0 or 5V	±13.5		±20	μA
Clock Input High	V _{IH}		4.5			V
Clock Input Low	V _{IL}		0.5			V

5th-Order, Lowpass, Switched-Capacitor Filters

MAX7409/MAX7410/MAX7413/MAX7414

ELECTRICAL CHARACTERISTICS—MAX7409/MAX7410

($V_{DD} = +5V$, filter output measured at OUT, $10k\Omega \parallel 50pF$ load to GND at OUT, OS = COM, $0.1\mu F$ capacitor from COM to GND, $\overline{SHDN} = V_{DD}$, $f_{CLK} = 100kHz$, $T_A = T_{MIN}$ to T_{MAX} , unless otherwise noted. Typical values are at $T_A = +25^\circ C$.)

PARAMETER	SYMBOL	CONDITIONS	MIN	TYP	MAX	UNITS
POWER REQUIREMENTS						
Supply Voltage	V_{DD}		4.5		5.5	V
Supply Current	I_{DD}	Operating mode, no load		1.2	1.5	mA
Shutdown Current	$I_{\overline{SHDN}}$	$\overline{SHDN} = GND$		0.2	1	μA
Power-Supply Rejection Ratio	PSRR	IN = COM (Note 4)		70		dB
SHUTDOWN						
\overline{SHDN} Input High	V_{SDH}		4.5			V
\overline{SHDN} Input Low	V_{SDL}				0.5	V
\overline{SHDN} Input Leakage Current		$V_{\overline{SHDN}} = 0$ to V_{DD}		± 0.2	± 10	μA

ELECTRICAL CHARACTERISTICS—MAX7413/MAX7414

($V_{DD} = +3V$, filter output measured at OUT pin, $10k\Omega \parallel 50pF$ load to GND at OUT, OS = COM, $0.1\mu F$ capacitor from COM to GND, $\overline{SHDN} = V_{DD}$, $f_{CLK} = 100kHz$, $T_A = T_{MIN}$ to T_{MAX} , unless otherwise noted. Typical values are at $T_A = +25^\circ C$.)

PARAMETER	SYMBOL	CONDITIONS	MIN	TYP	MAX	UNITS
FILTER CHARACTERISTICS						
Corner Frequency	f_C	(Note 1)		0.001 to 15		kHz
Clock-to-Corner Ratio	f_{CLK} / f_C			100:1		
Clock-to-Corner Tempco				10		ppm/ $^\circ C$
Output Voltage Range			0.25	$V_{DD} - 0.25$		V
Output Offset Voltage	V_{OFFSET}	$V_{IN} = V_{COM} = V_{DD} / 2$		± 4	± 25	mV
DC Insertion Gain with Output Offset Removed		$V_{COM} = V_{DD} / 2$ (Note 2)	-0.2	0	+0.2	dB
Total Harmonic Distortion plus Noise	THD+N	$f_{IN} = 200Hz$, $V_{IN} = 2.5V_{p-p}$, measurement bandwidth = 22kHz		-83		dB
				-81		
Offset Voltage Gain	A_{OS}	OS to OUT		1		V/V
COM Voltage Range	V_{COM}	Input, COM externally driven	1.4	1.5	1.6	V
		Output, COM unconnected	1.4	1.5	1.6	V
Input Voltage Range at OS	V_{OS}	Input, OS externally driven		$V_{COM} \pm 0.1$		V
Input Resistance at COM	R_{COM}		110	180		$k\Omega$
Clock Feedthrough				3		mVp-p
Resistance Output Load Drive	R_L		10	1		$k\Omega$
Maximum Capacitive Output Load Drive	C_L		50	500		pF
Input Leakage Current at COM		$\overline{SHDN} = GND$, $V_{COM} = 0$ to V_{DD}		± 0.1	± 10	μA
Input Leakage Current at OS		$V_{OS} = 0$ to V_{DD}		± 0.1	± 10	μA

5th-Order, Lowpass, Switched-Capacitor Filters

ELECTRICAL CHARACTERISTICS—MAX7413/MAX7414 (continued)

($V_{DD} = +3V$, filter output measured at OUT pin, $10k\Omega \parallel 50pF$ load to GND at OUT, OS = COM, $0.1\mu F$ capacitor from COM to GND, $\overline{SHDN} = V_{DD}$, $f_{CLK} = 100kHz$, $T_A = T_{MIN}$ to T_{MAX} , unless otherwise noted. Typical values are at $T_A = +25^\circ C$.)

PARAMETER	SYMBOL	CONDITIONS	MIN	TYP	MAX	UNITS
CLOCK						
Internal Oscillator Frequency	f_{OSC}	$C_{OSC} = 1000pF$ (Note 3)	21	30	38	kHz
Clock Output Current (Internal Oscillator Mode)	I_{CLK}	$V_{CLK} = 0$ or $3V$		± 13.5	± 20	μA
Clock Input High	V_{IH}		2.5			V
Clock Input Low	V_{IL}				0.5	V
POWER REQUIREMENTS						
Supply Voltage	V_{DD}		2.7		3.6	V
Supply Current	I_{DD}	Operating mode, no load		1.2	1.5	mA
Shutdown Current	$I_{\overline{SHDN}}$	$\overline{SHDN} = GND$		0.2	1	μA
Power-Supply Rejection Ratio	PSRR	IN = COM (Note 4)		70		dB
SHUTDOWN						
\overline{SHDN} Input High	V_{SDH}		2.5			V
\overline{SHDN} Input Low	V_{SDL}				0.5	V
\overline{SHDN} Input Leakage Current		$V_{\overline{SHDN}} = 0$ to V_{DD}		0.2	± 10	μA

FILTER CHARACTERISTICS

($V_{DD} = +5V$ for MAX7409/MAX7410, $V_{DD} = +3V$ for MAX7413/MAX7414, filter output measured at OUT, $10k\Omega \parallel 50pF$ load to GND at OUT, $\overline{SHDN} = V_{DD}$, $f_{CLK} = 100kHz$, $T_A = T_{MIN}$ to T_{MAX} , unless otherwise noted.)

PARAMETER	CONDITIONS	MIN	TYP	MAX	UNITS
BESSEL FILTERS—MAX7409/MAX7413					
Insertion Gain Relative to DC Gain	$f_{IN} = 0.5f_C$	-1	-0.74		dB
	$f_{IN} = f_C$	-3.6	-3.0	-2.4	
	$f_{IN} = 4f_C$		-41.0	-35	
	$f_{IN} = 7f_C$		-64.3	-58	
BUTTERWORTH FILTERS—MAX7410/MAX7414					
Insertion Gain Relative to DC Gain	$f_{IN} = 0.5f_C$	-0.3	0		dB
	$f_{IN} = f_C$	-3.6	-3.0	-2.4	
	$f_{IN} = 3f_C$		-47.5	-43	
	$f_{IN} = 5f_C$		-70	-65	

Note 1: The maximum f_C is defined as the clock frequency $f_{CLK} = 100 \times f_C$ at which the peak S / (THD+N) drops to 68dB with a sinusoidal input at $0.2f_C$.

Note 2: DC insertion gain is defined as $\Delta V_{OUT} / \Delta V_{IN}$.

Note 3: f_{OSC} (kHz) $\cong 30 \times 10^3 / C_{OSC}$ (pF).

Note 4: PSRR is the change in output voltage from a V_{DD} of 4.5V and a V_{DD} of 5.5V.

5th-Order, Lowpass, Switched-Capacitor Filters

Typical Operating Characteristics

($V_{DD} = +5V$ for MAX7409/MAX7410, $V_{DD} = +3V$ for MAX7413/MAX7414, $f_{CLK} = 100kHz$, $\overline{SHDN} = V_{DD}$, $COM = OS = V_{DD} / 2$, $T_A = +25^\circ C$, unless otherwise noted.)

MAX7409/MAX7410/MAX7413/MAX7414

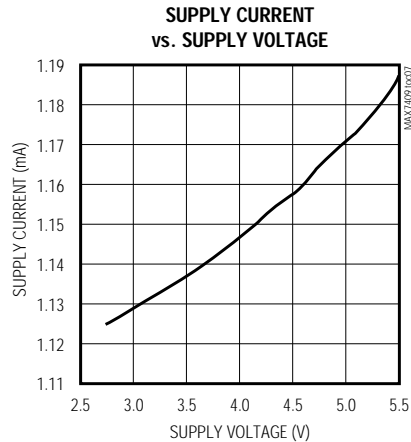
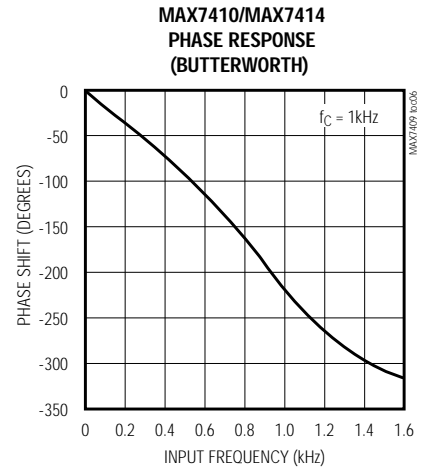
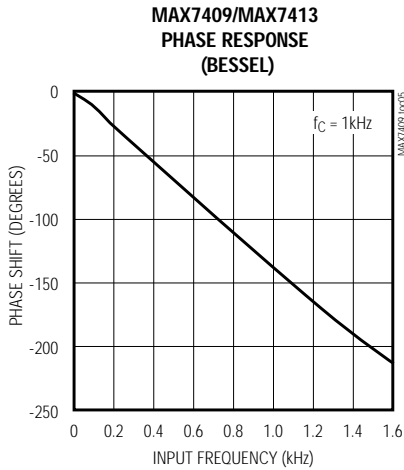
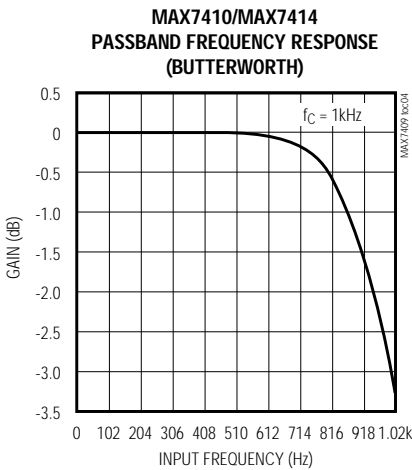
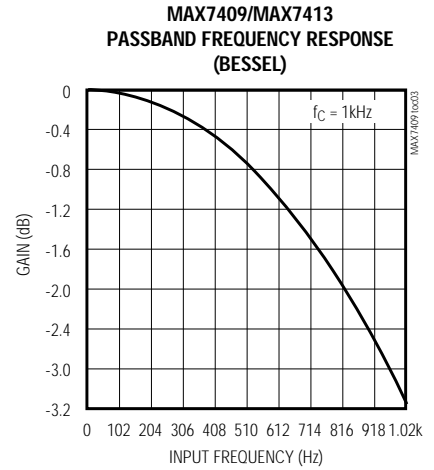
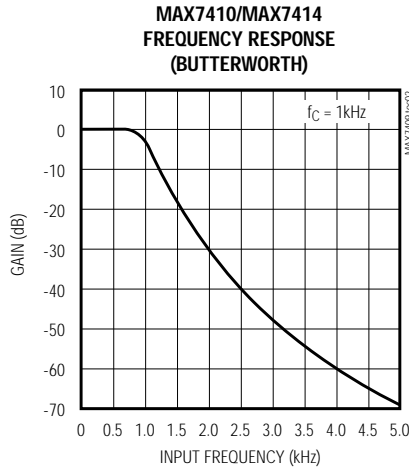
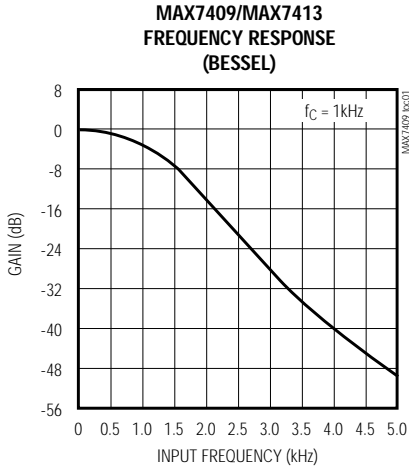

Table A. THD+N vs. Input Signal Amplitude Plot Characteristics

LABEL	f_{IN} (Hz)	f_c (kHz)	f_{CLK} (kHz)	MEASUREMENT BANDWIDTH (kHz)
A	200	1	100	22
B	1k	5	500	80

5th-Order, Lowpass, Switched-Capacitor Filters

Typical Operating Characteristics (continued)

($V_{DD} = +5V$ for MAX7409/MAX7410, $V_{DD} = +3V$ for MAX7413/MAX7414, $f_{CLK} = 100kHz$, $\overline{SHDN} = V_{DD}$, $COM = OS = V_{DD} / 2$, $T_A = +25^\circ C$, unless otherwise noted.)

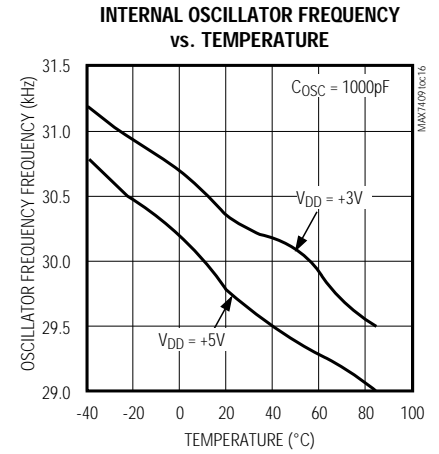
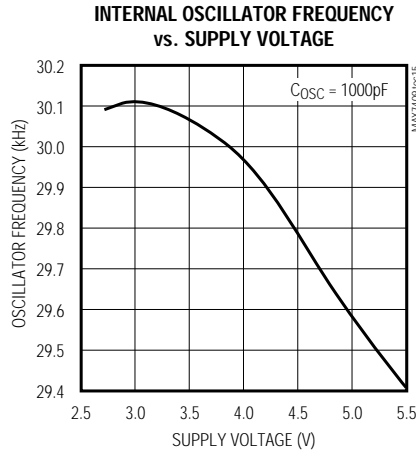
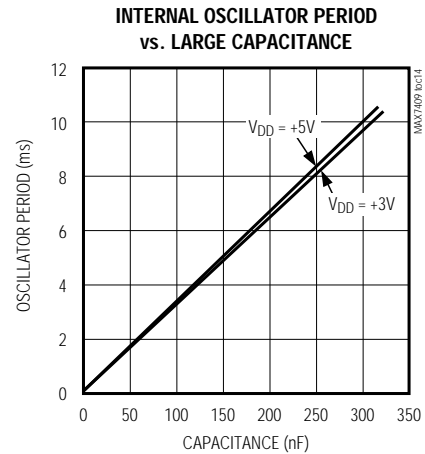
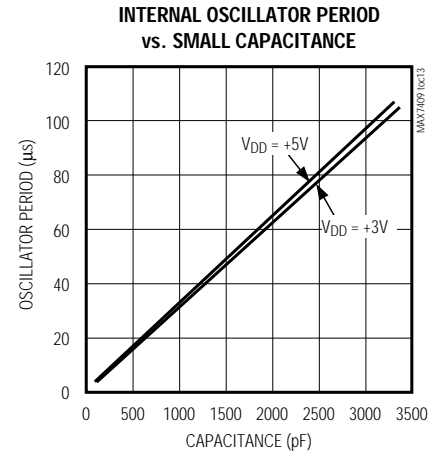
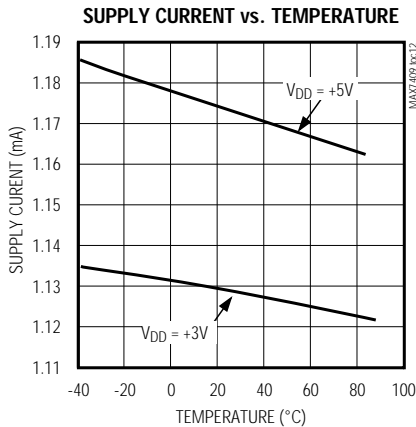
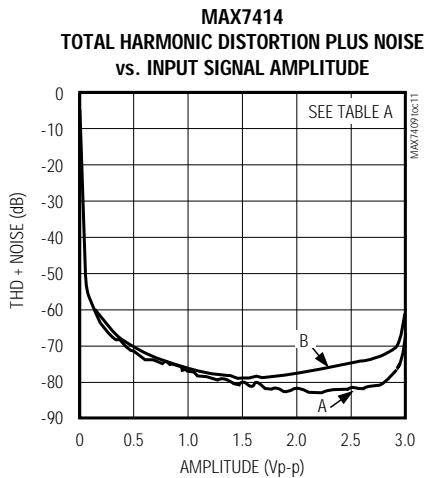
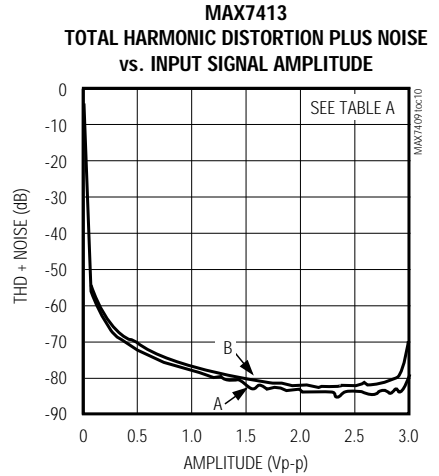
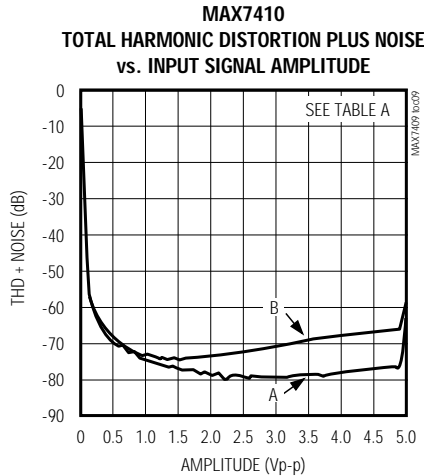
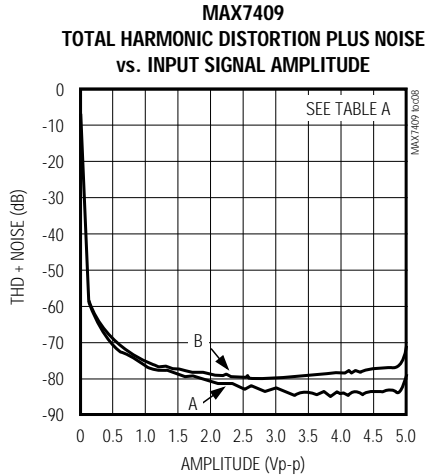

5th-Order, Lowpass, Switched-Capacitor Filters

MAX7409/MAX7410/MAX7413/MAX7414

Typical Operating Characteristics (continued)

($V_{DD} = +5V$ for MAX7409/MAX7410, $V_{DD} = +3V$ for MAX7413/MAX7414, $f_{CLK} = 100kHz$, $\overline{SHDN} = V_{DD}$, $COM = OS = V_{DD} / 2$, $T_A = +25^\circ C$, unless otherwise noted.)

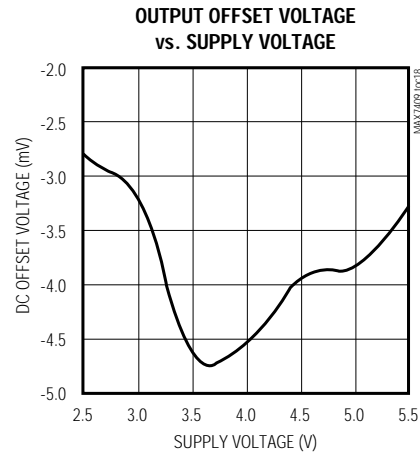
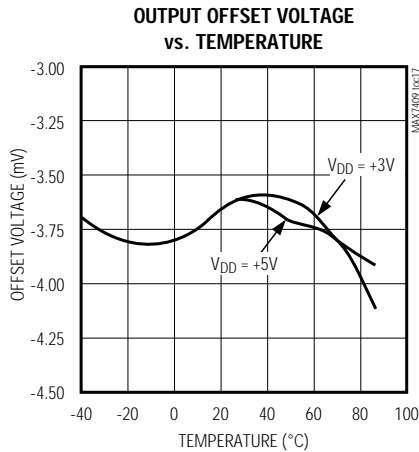

Pin Description

PIN	NAME	FUNCTION
1	COM	Common Input Pin. Biased internally at midsupply. Bypass COM externally to GND with a 0.1 μ F capacitor. To override internal biasing, drive COM with an external supply.
2	IN	Filter Input
3	GND	Ground
4	V_{DD}	Positive Supply Input: +5V for MAX7409/MAX7410, +3V for MAX7413/MAX7414.
5	OUT	Filter Output
6	OS	Offset Adjust Input. To adjust output offset, connect OS to an external supply through a resistive voltage-divider (Figure 3). Connect OS to COM if no offset adjustment is needed. Refer to the <i>Offset and Common-Mode Input Adjustment</i> section.
7	\overline{SHDN}	Shutdown Input. Drive low to enable shutdown mode; drive high or connect to V_{DD} for normal operation.
8	CLK	Clock Input. Connect an external capacitor (C_{OSC}) from CLK to ground: f_{OSC} (kHz) = $30 \times 10^3 / C_{OSC}$ (μ F). To override the internal oscillator, connect CLK to an external clock: $f_C = f_{CLK} / 100$.

Detailed Description

The MAX7409/MAX7413 Bessel filters provide low overshoot and fast settling responses, and the MAX7410/MAX7414 Butterworth filters provide a maximally flat passband response. All parts operate with a 100:1 clock-to-corner frequency ratio and a 15kHz maximum corner frequency.

Bessel Characteristics

Lowpass Bessel filters such as the MAX7409/MAX7413 delay all frequency components equally, preserving the shape of step inputs (subject to the attenuation of the

higher frequencies). Bessel filters settle quickly—an important characteristic in applications that use a multiplexer (mux) to select an input signal for an analog-to-digital converter (ADC). An anti-aliasing filter placed between the mux and the ADC must settle quickly after a new channel is selected.

Butterworth Characteristics

Lowpass Butterworth filters such as the MAX7410/MAX7414 provide a maximally flat passband response, making them ideal for instrumentation applications that require minimum deviation from the DC gain throughout the passband.

5th-Order, Lowpass, Switched-Capacitor Filters

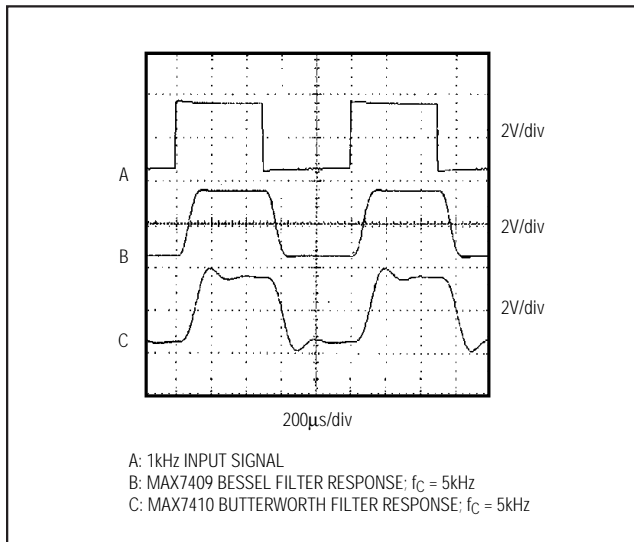

Figure 1. Bessel vs. Butterworth Filter Response

The difference between Bessel and Butterworth filters can be observed when a 1kHz square wave is applied to the filter input (Figure 1, trace A). With the filter cutoff frequencies set at 5kHz, trace B shows the Bessel filter response and trace C shows the Butterworth filter response.

Background Information

Most switched-capacitor filters (SCFs) are designed with biquadratic sections. Each section implements two filtering poles, and the sections are cascaded to produce higher-order filters. The advantage to this approach is ease of design. However, this type of design is highly sensitive to component variations if any section's Q is high. An alternative approach is to emulate a passive network using switched-capacitor integrators with summing and scaling. Figure 2 shows a basic 5th-order ladder filter structure.

A switched-capacitor filter such as the MAX7409/MAX7410/MAX7413/MAX7414 emulates a passive ladder filter. The filter's component sensitivity is low when compared to a cascaded biquad design, because each component affects the entire filter shape, not just one pole-zero pair. In other words, a mismatched component in a biquad design will have a concentrated error on its respective poles, while the same mismatch in a ladder filter design results in an error distributed over all poles.

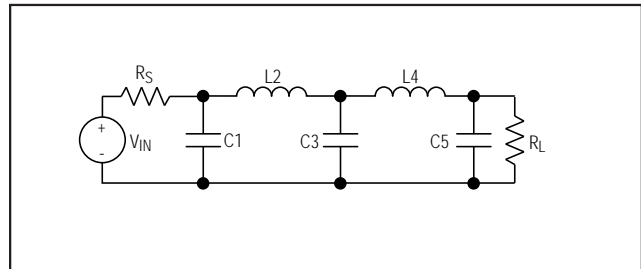

Figure 2. 5th-Order Ladder Filter Network

Clock Signal

External Clock

The MAX7409/MAX7410/MAX7413/MAX7414 family of SCFs is designed for use with external clocks that have a 50% \pm 10% duty cycle. When using an external clock with these devices, drive CLK with a CMOS gate powered from 0 to V_{DD} . Varying the rate of the external clock adjusts the corner frequency of the filter as follows:

$$f_C = f_{CLK} / 100$$

Internal Clock

When using the internal oscillator, connect a capacitor (C_{OSC}) between CLK and ground. The value of the capacitor determines the oscillator frequency as follows:

$$f_{OSC} \text{ (kHz)} = 30 \times 10^3 / C_{OSC} \text{ (pF)}$$

Minimize the stray capacitance at CLK so that it does not affect the internal oscillator frequency. Vary the rate of the internal oscillator to adjust the filter's corner frequency by a 100:1 clock-to-corner frequency ratio. For example, an internal oscillator frequency of 100kHz produces a nominal corner frequency of 1kHz.

Input Impedance vs. Clock Frequencies

The MAX7409/MAX7410/MAX7413/MAX7414's input impedance is effectively that of a switched-capacitor resistor (see the following equation), and is inversely proportional to frequency. The input impedance values determined below represent the average input impedance, since the input current is not continuous. As a rule, use a driver with an output impedance less than 10% of the filter's input impedance. Estimate the input impedance of the filter using the following formula:

$$Z_{IN} = 1 / (f_{CLK} \times 2.1 \text{ pF})$$

For example, an f_{CLK} of 100kHz results in an input impedance of 4.8M Ω .

5th-Order, Lowpass, Switched-Capacitor Filters

MAX7409/MAX7410/MAX7413/MAX7414

Low-Power Shutdown Mode

These devices feature a shutdown mode that is activated by driving $\overline{\text{SHDN}}$ low. In shutdown mode, the filter's supply current reduces to 0.2 μA and its output becomes high impedance. For normal operation, drive $\overline{\text{SHDN}}$ high or connect it to V_{DD} .

Applications Information

Offset and Common-Mode Input Adjustment

The COM pin sets the common-mode input voltage and is biased at mid-supply with an internal resistor-divider. If the application does not require offset adjustment, connect OS to COM. For applications requiring offset adjustment, apply an external bias voltage through a resistor-divider network to OS such as shown in Figure 3. For applications that require DC level shifting, adjust OS with respect to COM. (Note: OS should not be left unconnected.) The output voltage is represented by this equation:

$$V_{\text{OUT}} = (V_{\text{IN}} - V_{\text{COM}}) + V_{\text{OS}}$$

with $V_{\text{COM}} = V_{\text{DD}} / 2$ (typical), and where $(V_{\text{IN}} - V_{\text{COM}})$ is lowpass filtered by the SCF, and OS is added at the output stage. See the *Electrical Characteristics* for the voltage range of COM and OS. Changing the voltage on COM or OS significantly from midsupply reduces the filter's dynamic range.

Power Supplies

The MAX7409/MAX7410 operate from a single +5V supply and the MAX7413/MAX7414 operate from a single +3V supply. Bypass V_{DD} to GND with a 0.1 μF capacitor. If dual supplies are required ($\pm 2.5\text{V}$ for MAX7409/MAX7410, $\pm 1.5\text{V}$ for MAX7413/MAX7414), connect COM to system ground and connect GND to the negative supply. Figure 4 shows an example of dual-supply operation. Single- and dual-supply performance are equivalent. For either single- or dual-supply operation, drive CLK and $\overline{\text{SHDN}}$ from GND (V^- in dual-supply operation) to V_{DD} . For $\pm 5\text{V}$ dual-supply applications, use the MAX291–MAX297.

Input Signal Amplitude Range

The optimal input signal range is determined by observing the voltage level at which the Total Harmonic Distortion + Noise is minimized for a given corner frequency. The *Typical Operating Characteristics* show graphs of the devices' Total Harmonic Distortion plus Noise Response as the input signal's peak-to-peak amplitude is varied.

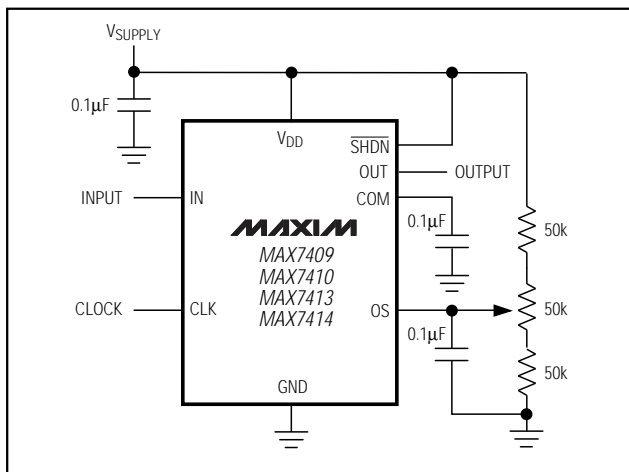

Figure 3. Offset Adjustment Circuit

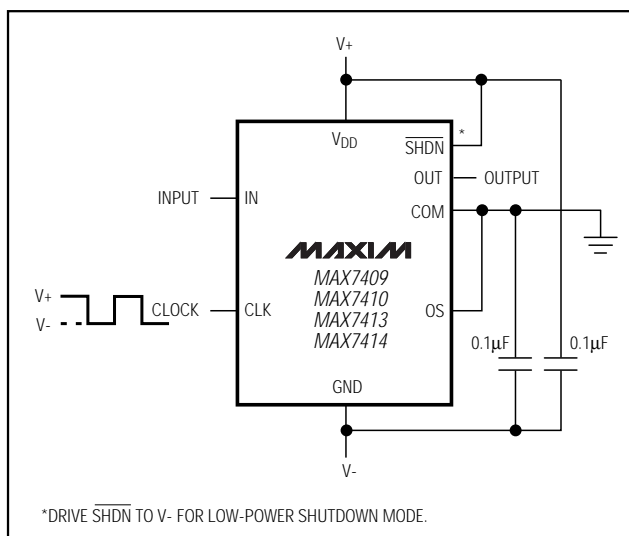

Figure 4. Dual-Supply Operation

Anti-Aliasing and DAC Postfiltering

When using these devices for anti-aliasing or DAC postfiltering, synchronize the DAC (or ADC) and the filter clocks. If the clocks are not synchronized, beat frequencies will alias into the desired passband.

Harmonic Distortion

Harmonic distortion arises from nonlinearities within the filter. These nonlinearities generate harmonics when a pure sine wave is applied to the filter input. Table 1 lists typical harmonic-distortion values for the MAX7410/MAX7414 with a 10k Ω load at $T_A = +25^\circ\text{C}$. Table 2 lists typical harmonic-distortion values for the MAX7409/MAX7413 with a 10k Ω load at $T_A = +25^\circ\text{C}$.

5th-Order, Lowpass, Switched-Capacitor Filters

MAX7409/MAX7410/MAX7413/MAX7414

Table 1. MAX7410/MAX7414 Typical Harmonic Distortion

FILTER	f _{CLK} (kHz)	f _{IN} (Hz)	V _{IN} (V _{p-p})	TYPICAL HARMONIC DISTORTION (dB)			
				2nd	3rd	4th	5th
MAX7410	500	1k	4	-85	-67	-86.7	-82
	100	200		-84	-78	-88.7	-88.5
MAX7414	500	1k	2	-85.3	-74	-87.1	-87.6
	100	200		-86.1	-85.5	-85.8	-86.4

Table 2. MAX7409/MAX7413 Typical Harmonic Distortion

FILTER	f _{CLK} (kHz)	f _{IN} (Hz)	V _{IN} (V _{p-p})	TYPICAL HARMONIC DISTORTION (dB)			
				2nd	3rd	4th	5th
MAX7409	500	1k	4	-82.5	-79	-88.8	-91.1
	100	200		-83.5	-85.4	-88.4	-88.8
MAX7413	500	1k	2	-86	-81	-87.3	-87.9
	100	200		-86.4	-86.9	-87.9	-88.3

Ordering Information (continued)

PART	TEMP. RANGE	PIN-PACKAGE
MAX7413 CUA	0°C to +70°C	8 μMAX
MAX7413CPA	0°C to +70°C	8 Plastic DIP
MAX7413EUA	-40°C to +85°C	8 μMAX
MAX7413EPA	-40°C to +85°C	8 Plastic DIP
MAX7414 CUA	0°C to +70°C	8 μMAX
MAX7414CPA	0°C to +70°C	8 Plastic DIP
MAX7414EUA	-40°C to +85°C	8 μMAX
MAX7414EPA	-40°C to +85°C	8 Plastic DIP

Chip Information

TRANSISTOR COUNT: 1457

5th-Order, Lowpass, Switched-Capacitor Filters

Package Information

MAX7409/MAX7410/MAX7413/MAX7414

BLUMAXD.EPS

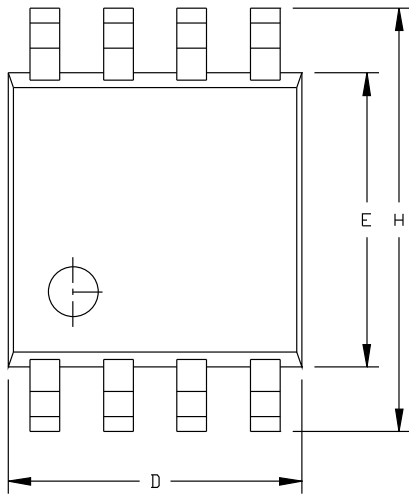

	INCHES		MILLIMETERS	
	MIN	MAX	MIN	MAX
A	0.036	0.044	0.91	1.11
A1	0.004	0.008	0.10	0.20
B	0.010	0.014	0.25	0.36
C	0.005	0.007	0.13	0.18
D	0.116	0.120	2.95	3.05
e	0.0256		0.65	
E	0.116	0.120	2.95	3.05
H	0.188	0.198	4.78	5.03
L	0.016	0.026	0.41	0.66
α	0°	6°	0°	6°

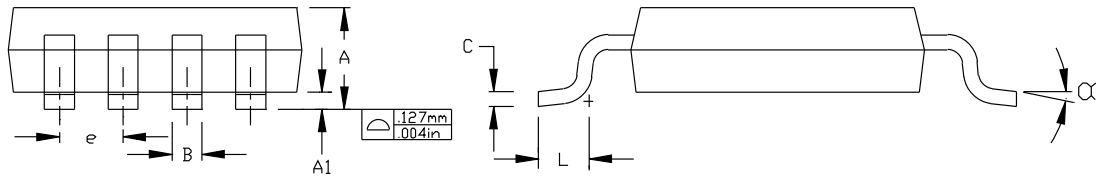

NOTES:

1. D&E DO NOT INCLUDE MOLD FLASH.
2. MOLD FLASH OR PROTRUSIONS NOT TO EXCEED .15mm(.006").
3. CONTROLLING DIMENSION: INCHES

MAXIM		
<small>PROPRIETARY INFORMATION</small>		
<small>TITLE:</small>		
8LD uMAX PACKAGE OUTLINE DWG.		
<small>APPROVAL</small>	<small>DOCUMENT CONTROL NO.</small>	<small>REV</small>
	21-0036	D 1/1

5th-Order, Lowpass, Switched-Capacitor Filters

Package Information (continued)

MECHANICAL DRAWING: The drawing shows a top view and a side view of a DIP package. Dimensions are labeled as follows: A (height of lead), A1 (lead height), A2 (lead height), A3 (lead height), B (lead length), B1 (lead length), C (lead length), D (package width), D1 (lead width), E (package length), E1 (package length), e (lead pitch), eA (lead pitch), eB (lead pitch), L (lead length), and N (number of pins). A lead angle of 0°-15° is indicated.

	INCHES		MILLIMETERS	
	MIN	MAX	MIN	MAX
A	---	0.200	---	5.08
A1	0.015	---	0.38	---
A2	0.125	0.175	3.18	4.45
A3	0.055	0.080	1.40	2.03
B	0.016	0.022	0.41	0.56
B1	0.045	0.065	1.14	1.65
C	0.008	0.012	0.20	0.30
D1	0.005	0.080	0.13	2.03
E	0.300	0.325	7.62	8.26
E1	0.240	0.310	6.10	7.87
e	0.100	---	2.54	---
eA	0.300	---	7.62	---
eB	---	0.400	---	10.16
L	0.115	0.150	2.92	3.81

	INCHES		MILLIMETERS		N	MS001
	MIN	MAX	MIN	MAX		
D	0.348	0.390	8.84	9.91	8	AB
D	0.735	0.765	18.67	19.43	14	AC
D	0.745	0.765	18.92	19.43	16	AA
D	0.885	0.915	22.48	23.24	18	AD
D	1.015	1.045	25.78	26.54	20	AE
D	1.14	1.265	28.96	32.13	24	AF
D	1.360	1.380	34.54	35.05	28	*5

NOTES:
 1. D&E DO NOT INCLUDE MOLD FLASH
 2. MOLD FLASH OR PROTRUSIONS NOT TO EXCEED .15mm (.006")
 3. CONTROLLING DIMENSION: MILLIMETER
 4. MEETS JEDEC MS001-XX AS SHOWN IN ABOVE TABLE
 5. SIMILAR TO JEDEC MO-058AB
 6. N = NUMBER OF PINS

MAXIM INTEGRATED PRODUCTS
 12 SAN GABRIEL DRIVE, SUNNYVALE, CALIFORNIA 94086-7600
 PROPRIETARY INFORMATION

PACKAGE FAMILY OUTLINE: PDIP .300" 1/1 21-0043 A
 TITLE DOCUMENT CONTROL NUMBER REV

Maxim cannot assume responsibility for use of any circuitry other than circuitry entirely embodied in a Maxim product. No circuit patent licenses are implied. Maxim reserves the right to change the circuitry and specifications without notice at any time.

12 Maxim Integrated Products, 120 San Gabriel Drive, Sunnyvale, CA 94086 408-737-7600