

IGBT Modules in ECO-PAC 2

Short Circuit SOA Capability
 Square RBSOA

$I_{C25} = 69 \text{ A}$
 $V_{CES} = 600 \text{ V}$
 $V_{CE(sat) \text{ typ.}} = 2.3 \text{ V}$

Preliminary data sheet

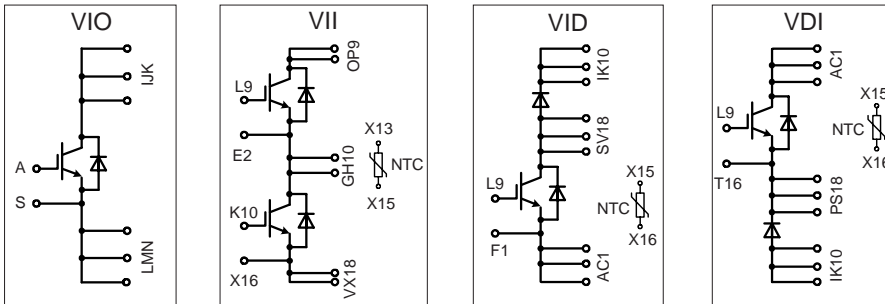

Pin arrangement see outlines

IGBTs

Symbol	Conditions	Maximum Ratings	
V_{CES}	$T_{VJ} = 25^{\circ}\text{C to } 150^{\circ}\text{C}$	600	V
V_{GES}		± 20	V
I_{C25}	$T_C = 25^{\circ}\text{C}$	69	A
I_{C80}	$T_C = 80^{\circ}\text{C}$	48	A
I_{CM} V_{CEK}	$V_{GE} = \pm 15 \text{ V}; R_G = 22 \Omega; T_{VJ} = 125^{\circ}\text{C}$ RBSOA, Clamped inductive load; $L = 100 \mu\text{H}$	100	A
		V_{CES}	
t_{SC} (SCSOA)	$V_{CE} = V_{CES}; V_{GE} = \pm 15 \text{ V}; R_G = 22 \Omega; T_{VJ} = 125^{\circ}\text{C}$ non-repetitive	10	μs
P_{tot}	$T_C = 25^{\circ}\text{C}$	208	W

Features

- NPT IGBT's
 - positive temperature coefficient of saturation voltage
 - fast switching
- FRED diodes
 - fast reverse recovery
 - low forward voltage
- Industry Standard Package
 - solderable pins for PCB mounting
 - isolated DCB ceramic base plate

Advantages

- space and weight savings
- reduced protection circuits
- leads with expansion bend for stress relief

Typical Applications

- AC and DC motor control
- AC servo and robot drives
- power supplies
- welding inverters

Symbol	Conditions	Characteristic Values ($T_{VJ} = 25^{\circ}\text{C}$, unless otherwise specified)			
		min.	typ.	max.	
$V_{CE(sat)}$	$I_C = 75 \text{ A}; V_{GE} = 15 \text{ V}; T_{VJ} = 25^{\circ}\text{C}$ $T_{VJ} = 125^{\circ}\text{C}$	2.3	2.8	V	
			2.8	V	
$V_{GE(th)}$	$I_C = 1 \text{ mA}; V_{GE} = V_{CE}$	4.5		V	
I_{CES}	$V_{CE} = V_{CES}; V_{GE} = 0 \text{ V}; T_{VJ} = 25^{\circ}\text{C}$ $T_{VJ} = 125^{\circ}\text{C}$			0.8 mA 4.4 mA	
I_{GES}	$V_{CE} = 0 \text{ V}; V_{GE} = \pm 20 \text{ V}$			100 nA	
$t_{d(on)}$ t_r $t_{d(off)}$ t_f E_{on} E_{off}	Inductive load, $T_{VJ} = 125^{\circ}\text{C}$ $V_{CE} = 300 \text{ V}; I_C = 40 \text{ A}$ $V_{GE} = 15/0 \text{ V}; R_G = 22 \Omega$		50	ns	
				55	ns
				300	ns
				30	ns
				1.8	mJ
				1.4	mJ
C_{ies}	$V_{CE} = 25 \text{ V}; V_{GE} = 0 \text{ V}; f = 1 \text{ MHz}$		2.8	nF	
R_{thJC} R_{thJH}	(per IGBT) with heatsink compound (0.42 K/m.K; 50 μm)		1.2	0.6 K/W K/W	

IXYS reserves the right to change limits, test conditions and dimensions.

Reverse diodes (FRED)

Symbol	Conditions	Maximum Ratings	
I_{F25}	$T_C = 25^\circ\text{C}$	56	A
I_{F80}	$T_C = 80^\circ\text{C}$	35	A

Symbol	Conditions	Characteristic Values		
		min.	typ.	max.
V_F	$I_F = 40\text{ A}; T_{VJ} = 25^\circ\text{C}$ $T_{VJ} = 125^\circ\text{C}$	2.32	2.59	V
I_{RM} t_{rr}	$I_F = 30\text{ A}; di_F/dt = 500\text{ A}/\mu\text{s}; T_{VJ} = 125^\circ\text{C}$ $V_R = 300\text{ V}; V_{GE} = 0\text{ V}$	15	70	A ns
R_{thJC} R_{thJH}	with heatsink compound (0.42 K/m.K; 50 μm)	2.6	1.3	K/W K/W

Temperature Sensor NTC

Symbol	Conditions	Characteristic Values		
		min.	typ.	max.
R_{25}	$T = 25^\circ\text{C}$	4.75	5.0	k Ω
$B_{25/50}$			3375	K

Module

Symbol	Conditions	Maximum Ratings	
T_{VJ}		-40...+150	$^\circ\text{C}$
T_{stg}		-40...+150	$^\circ\text{C}$
V_{ISOL}	$I_{ISOL} \leq 1\text{ mA}; 50/60\text{ Hz}$	3000	V~
M_d	mounting torque (M4)	1.5 - 2.0	Nm
		14 - 18	lb.in.
a	Max. allowable acceleration	50	m/s ²

Symbol	Conditions	Characteristic Values		
		min.	typ.	max.
d_s	Creepage distance on surface (Pin to heatsink)	11.2		mm
d_A	Strike distance in air (Pin to heatsink)	11.2		mm
Weight		24		g

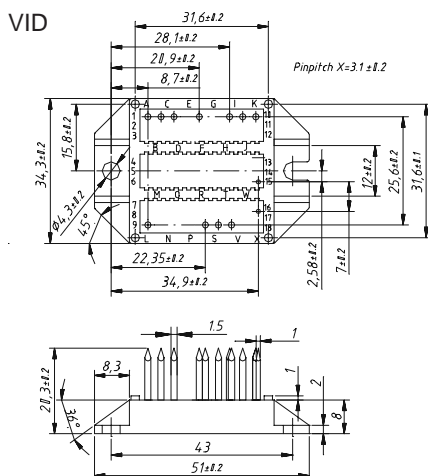
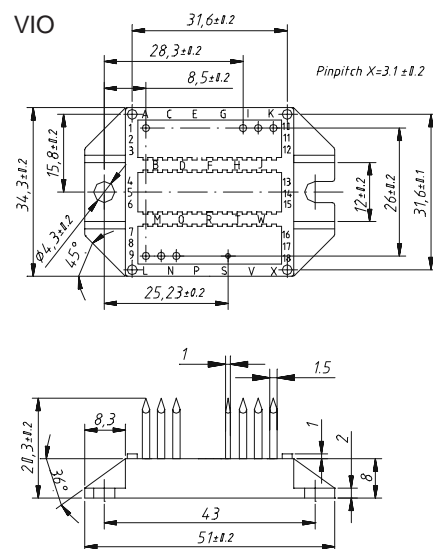
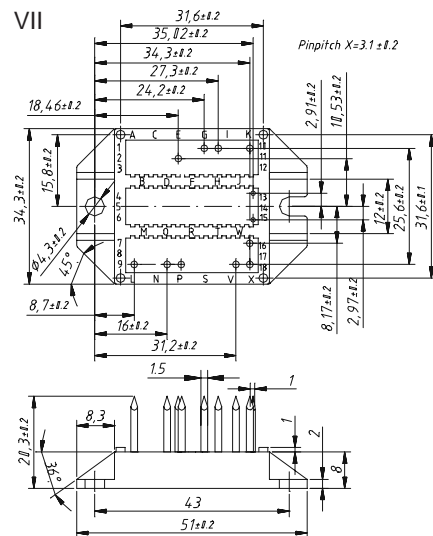

VDI

Data according to IEC 60747 and refer to a single transistor or diode unless otherwise stated.
IXYS reserves the right to change limits, test conditions and dimensions.

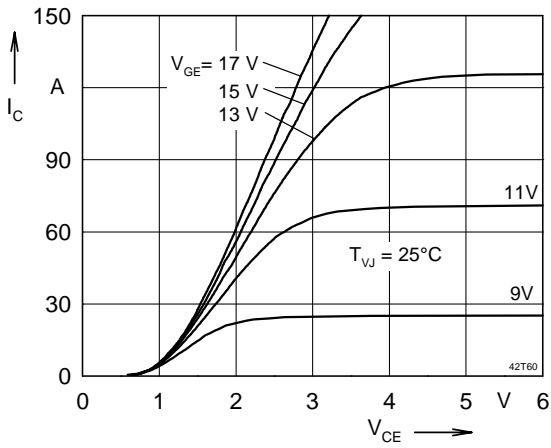

Fig. 1 Typ. output characteristics

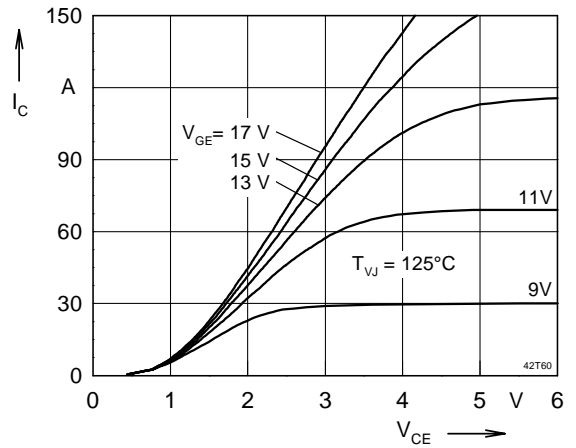

Fig. 2 Typ. output characteristics

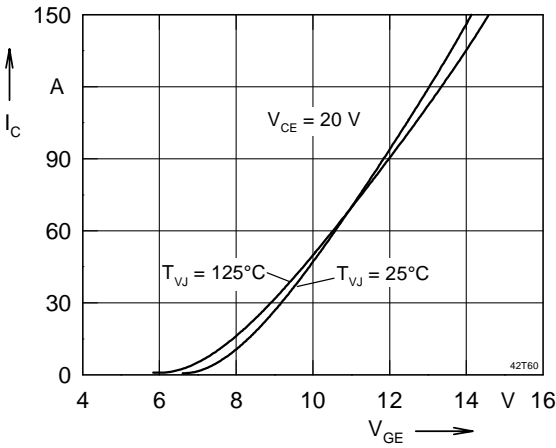

Fig. 3 Typ. transfer characteristics

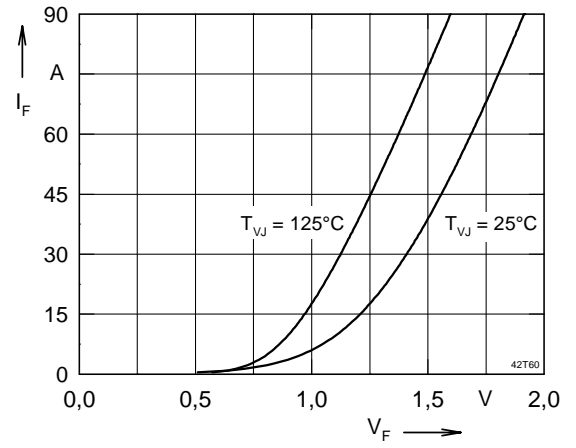

Fig. 4 Typ. forward characteristics of free wheeling diode

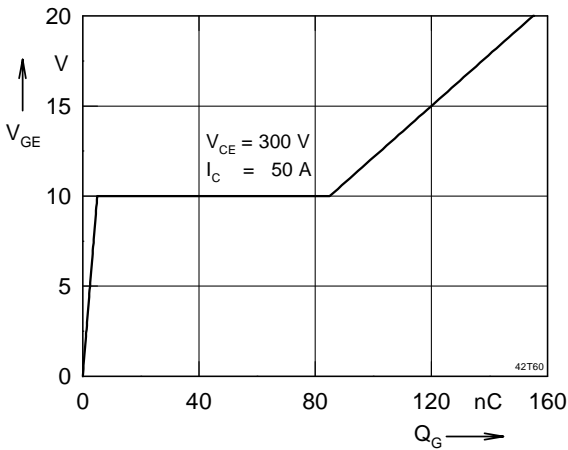

Fig. 5 Typ. turn on gate charge

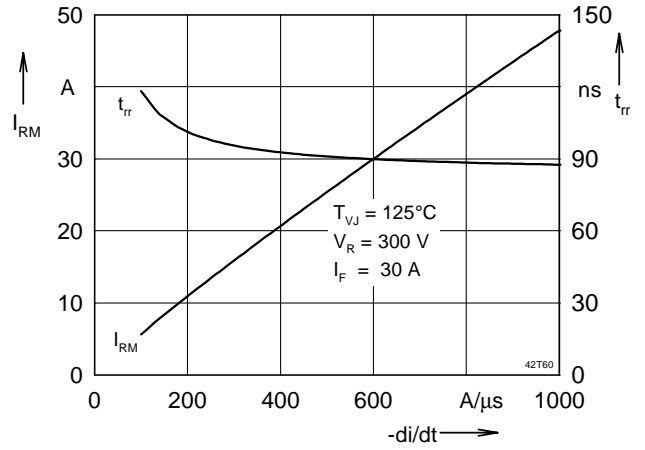

Fig. 6 Typ. turn off characteristics of free wheeling diode

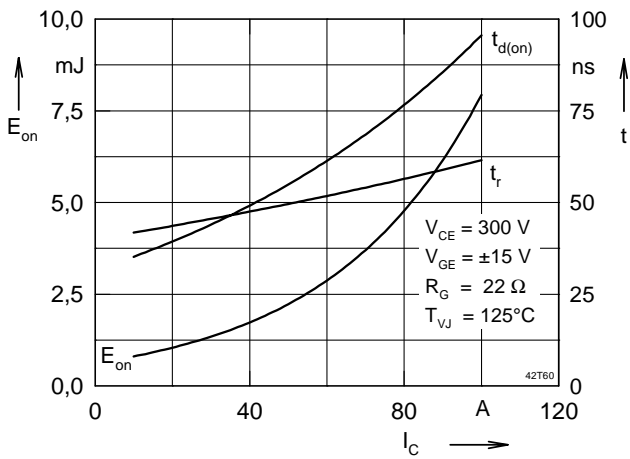

Fig. 7 Typ. turn on energy and switching

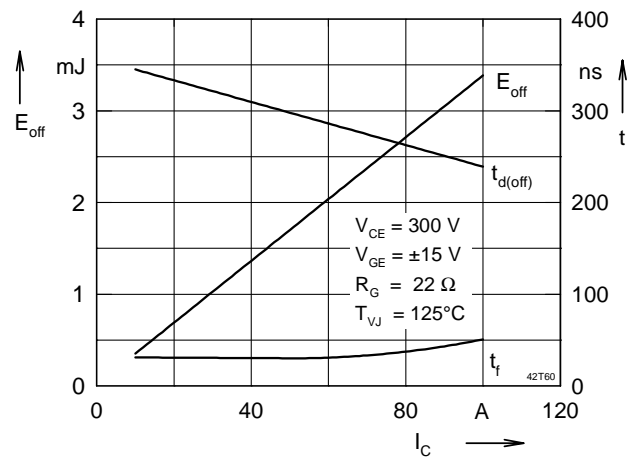

Fig. 8 Typ. turn off energy and switching times versus collector current

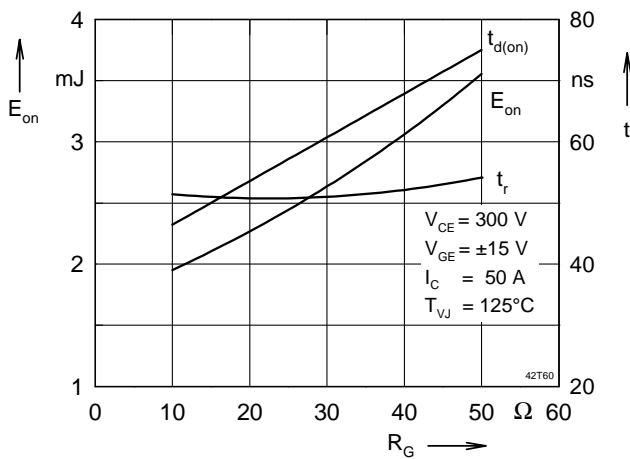

Fig. 9 Typ. turn on energy and switching

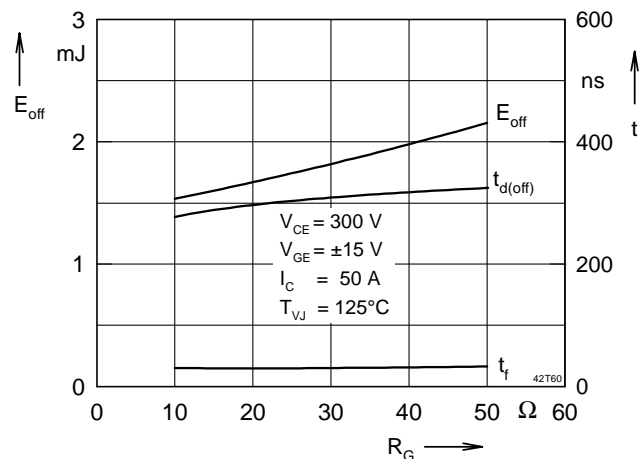

Fig. 10 Typ. turn off energy and switching times versus gate resistor

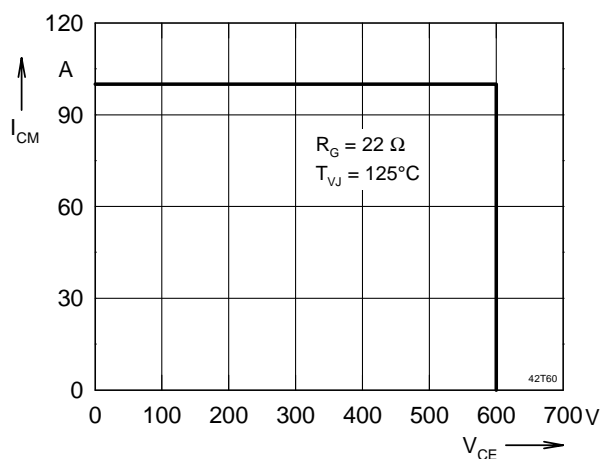

Fig. 11 Reverse biased safe operating area

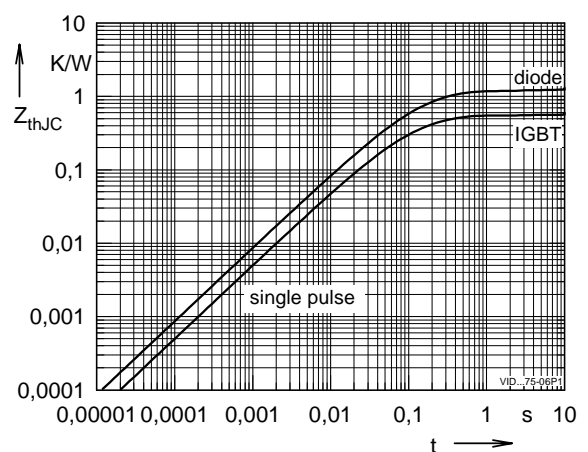

Fig. 12 Typ. transient thermal impedance RBSOA