

International  
**IR** Rectifier

## SAFEIR Series 10ETS12, 10ETS12S

### INPUT RECTIFIER DIODE

#### Description/Features

The 10ETS.. rectifier **SAFEIR** series has been optimized for very low forward voltage drop, with moderate leakage. The glass passivation technology used has reliable operation up to 150°C junction temperature.

Typical applications are in input rectification and these products are designed to be used with International Rectifier Switches and Output Rectifiers which are available in identical package outlines.

	$V_F < 1V @ 10A$
	$I_{FSM} = 200A$
	$V_{RRM} 800 \text{ to } 1200V$

#### Package Outline

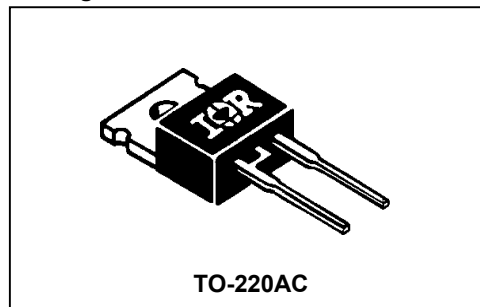

#### Major Ratings and Characteristics

Characteristics	10ETS..	Units
$I_{F(AV)}$ Sinusoidal waveform	10	A
$V_{RRM}$ Range	800 to 1200	V
$I_{FSM}$	200	A
$V_F @ 10A, T_J = 25^\circ C$	1.1	V
$T_J$	-40 to 150	$^\circ C$

#### Package Outline

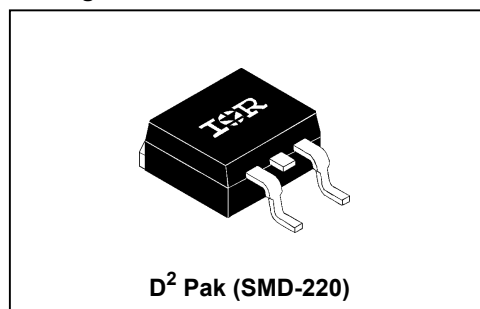

#### Output Current in Typical Applications

Applications	Single-phase Bridge	Three-phase Bridge	Units
Capacitive input filter $T_A = 55^\circ C, T_J = 125^\circ C$ common heatsink of $1^\circ C/W$	12.0	16.0	A

**Voltage Ratings**

Part Number	$V_{RRM}$ , maximum peak reverse voltage V	$V_{RSM}$ , maximum non repetitive peak reverse voltage V	$I_{RRM}$ 150°C mA
10ETS08, 10ETS08S	800	900	0.5
10ETS12, 10ETS12S	1200	1300	

**Absolute Maximum Ratings**

Parameters	10ETS..	Units	Conditions
$I_{F(AV)}$ Max. Average Forward Current	10	A	@ $T_C = 105^\circ\text{C}$ , 180° conduction half sine wave
$I_{FSM}$ Max. Peak One Cycle Non-Repetitive Surge Current	170	A	10ms Sine pulse, rated $V_{RRM}$ applied
	200		10ms Sine pulse, no voltage reapplied
$I^2t$ Max. $I^2t$ for fusing	130	$A^2s$	10ms Sine pulse, rated $V_{RRM}$ applied
	145		10ms Sine pulse, no voltage reapplied
$I^2\sqrt{t}$ Max. $I^2\sqrt{t}$ for fusing	1450	$A^2\sqrt{s}$	t = 0.1 to 10ms, no voltage reapplied

**Electrical Specifications**

Parameters	10ETS..	Units	Conditions
$V_{FM}$ Max. Forward Voltage Drop	1.1	V	@ 10A, $T_J = 25^\circ\text{C}$
$r_t$ Forward slope resistance	20	mΩ	$T_J = 150^\circ\text{C}$
$V_{F(TO)}$ Threshold voltage	0.82	V	
$I_{RM}$ Max. Reverse Leakage Current	0.05	mA	$T_J = 25^\circ\text{C}$
	0.50		$T_J = 150^\circ\text{C}$

$V_R = \text{rated } V_{RRM}$

**Thermal-Mechanical Specifications**

Parameters	10ETS..	Units	Conditions
$T_J$ Max. Junction Temperature Range	-40 to 150	°C	
$T_{stg}$ Max. Storage Temperature Range	-40 to 150	°C	
$R_{thJC}$ Max. Thermal Resistance Junction to Case	2.5	°C/W	DC operation
$R_{thJA}$ Max. Thermal Resistance Junction to Ambient (PCB Mount)*	62	°C/W	
$T_s$ Soldering Temperature	240	°C	
wt Approximate Weight	2(0.07)	g(oz.)	
Case Style	TO-220AC, D <sup>2</sup> Pak (SMD-220)		

\* When mounted on 1" square (650mm<sup>2</sup>) PCB of FR-4 or G-10 material 4 oz (140µm) copper 40°C/W  
For recommended footprint and soldering techniques refer to application note #AN-994

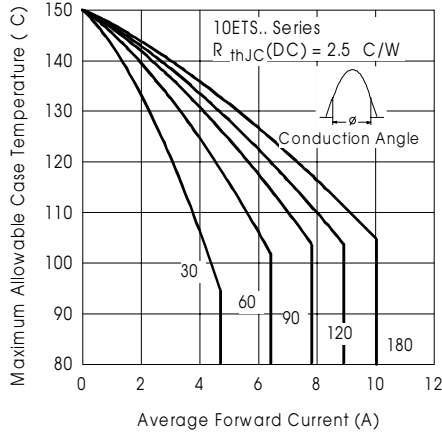

Fig. 1 - Current Rating Characteristics

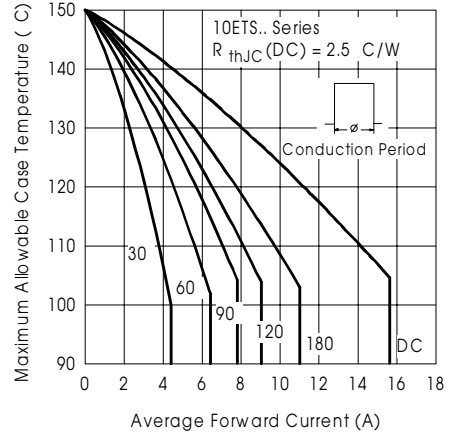

Fig. 2 - Current Rating Characteristics

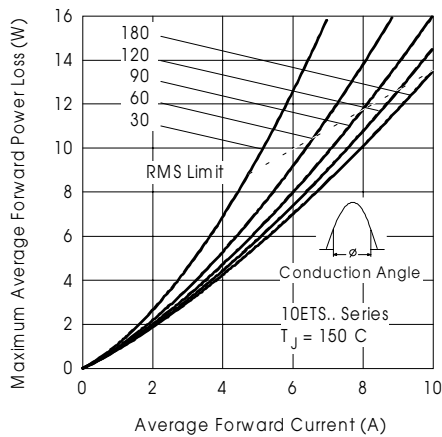

Fig. 3 - Forward Power Loss Characteristics

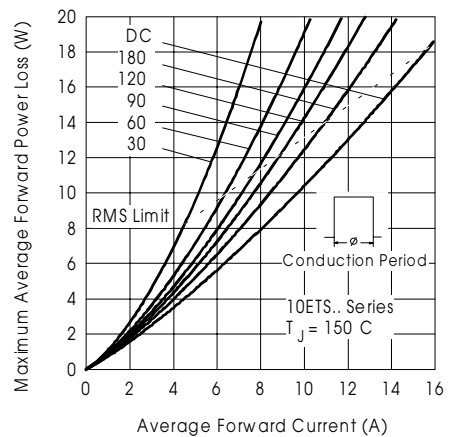

Fig. 4 - Forward Power Loss Characteristics

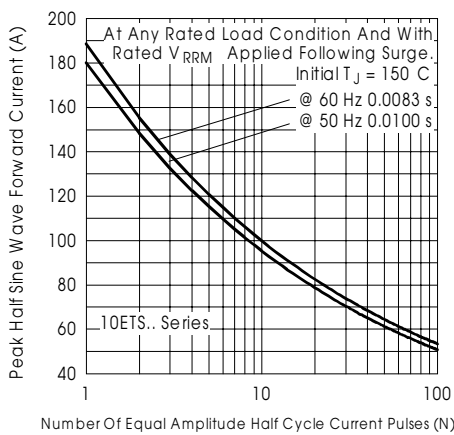

Fig. 5 - Maximum Non-Repetitive Surge Current

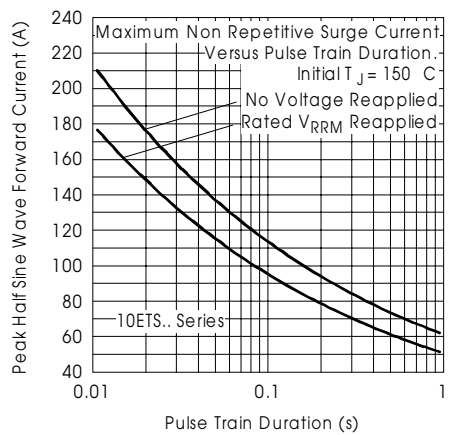

Fig. 6 - Maximum Non-Repetitive Surge Current

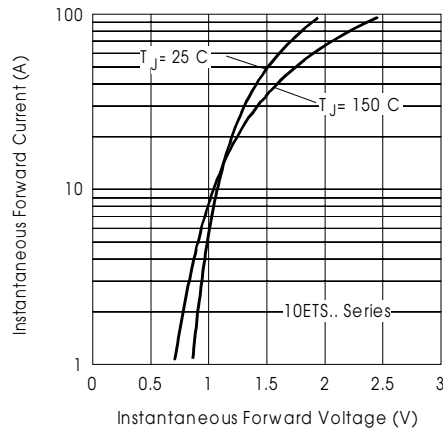

Fig. 8- Forward Voltage Drop Characteristics

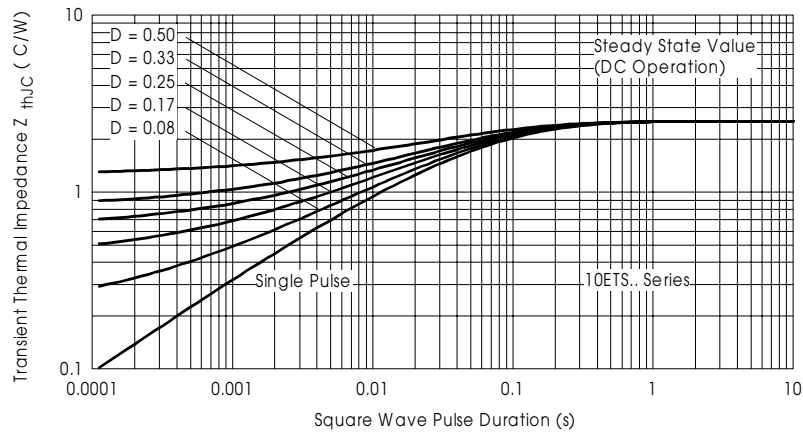
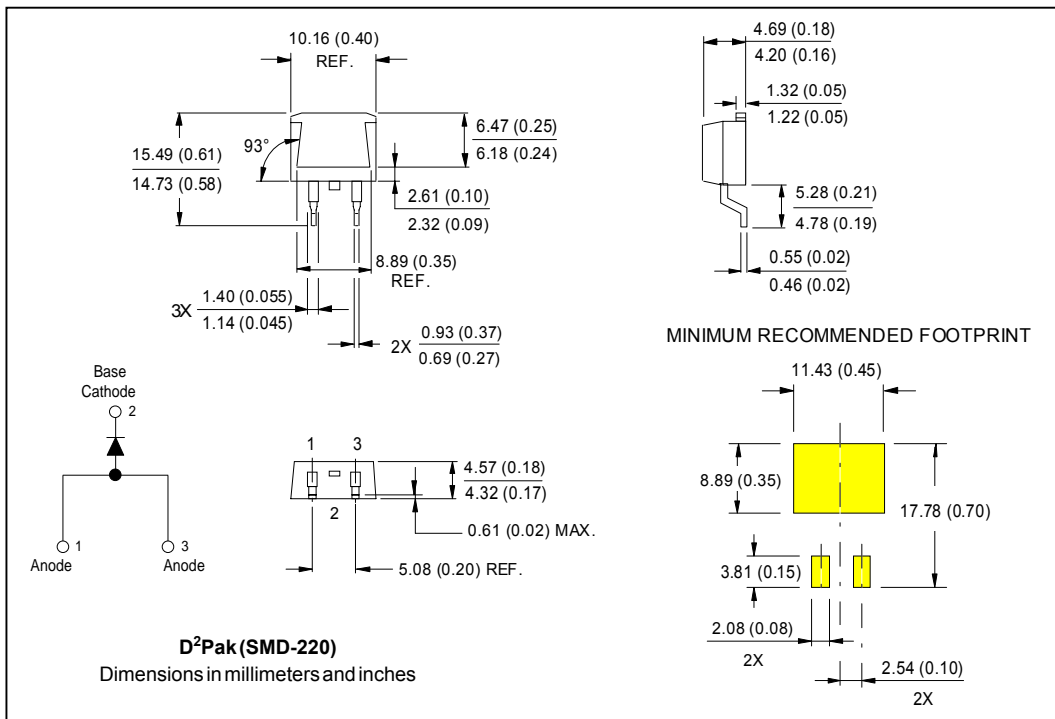
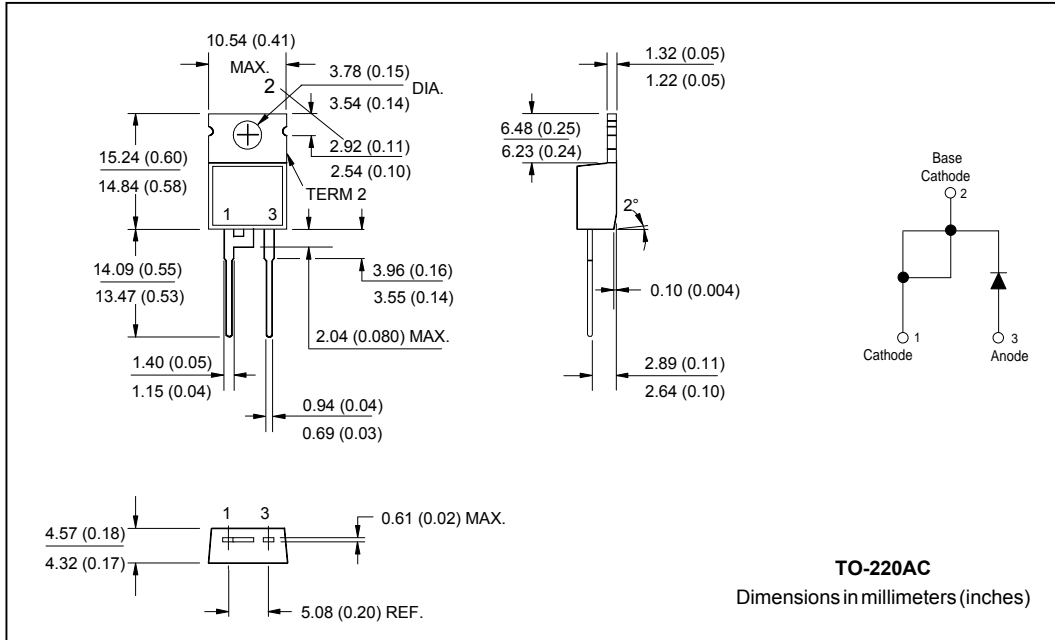
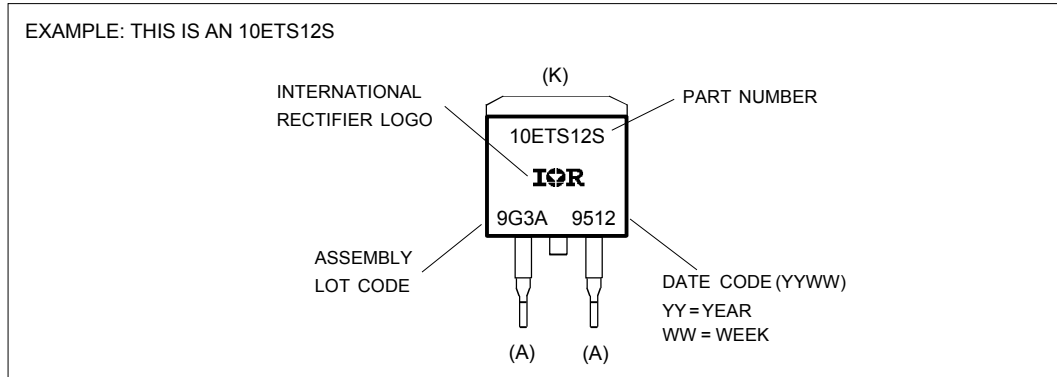

Fig. 9- Thermal Impedance  $Z_{thjC}$  Characteristics

Outline Table



Marking Information



Tape & Reel Information

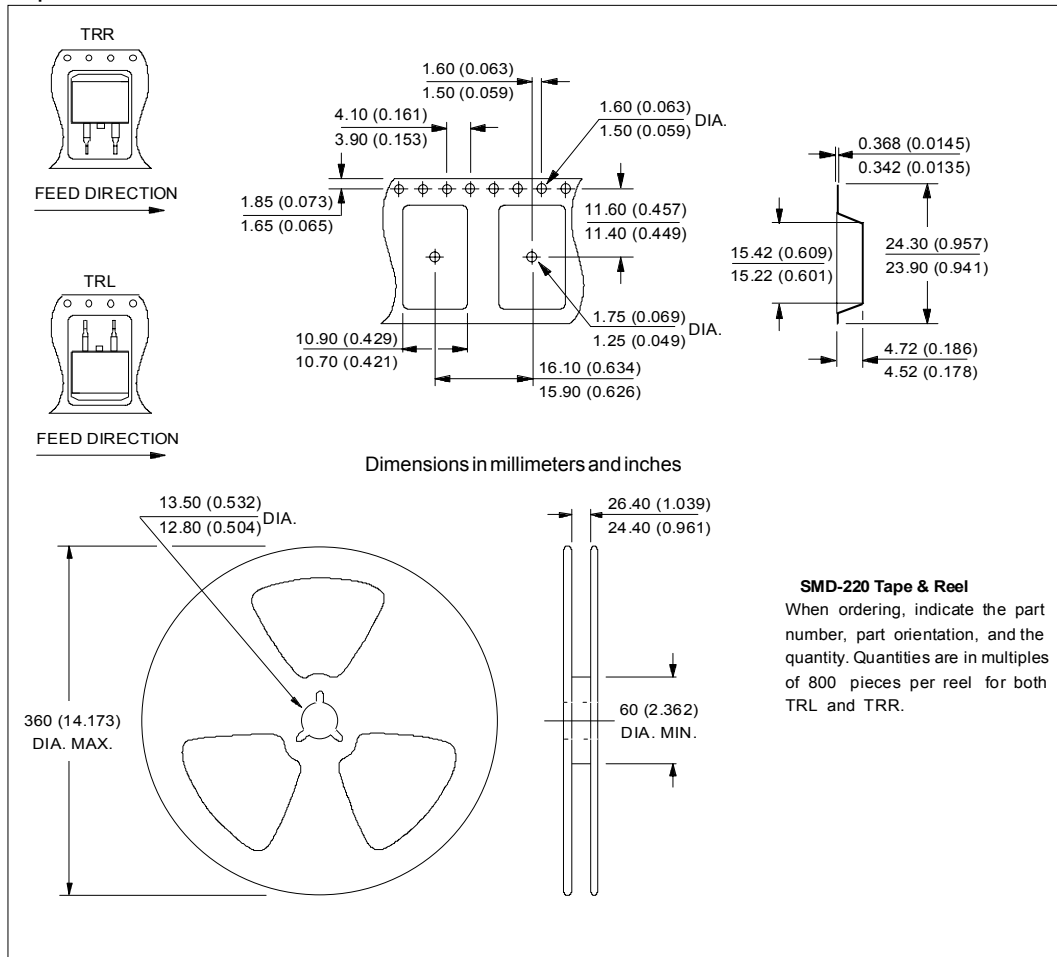

Ordering Information Table

Device Code						
<b>10</b>	<b>E</b>	<b>T</b>	<b>S</b>	<b>12</b>	<b>S</b>	<b>TRL</b>
①	②	③	④	⑤	⑥	⑦
<b>1</b>	-	Current Rating				
<b>2</b>	-	Circuit Configuration				
		E = Single Diode				
<b>3</b>	-	Package				
		T = TO-220AC				
<b>4</b>	-	Type of Silicon				
		S = Standard Recovery Rectifier				
<b>5</b>	-	Voltage code: Code x 100 = $V_{RRM}$				
<b>6</b>	-	S = TO-220 D <sup>2</sup> Pak (SMD-220) Version				
<b>7</b>	-	Tape and Reel Option				
		TRL = Left Reel				
		TRR = Right Orientation Reel				

08 = 800V  
 12 = 1200V

Data and specifications subject to change without notice.  
 This product has been designed and qualified for Industrial Level.  
 Qualification Standards can be found on IR's Web site.