

Cool MOS™ Power Transistor



- New revolutionary high voltage technology
- Ultra low gate charge
- Periodic avalanche rated
- Extreme dv/dt rated
- Optimized capacitances
- Improved noise immunity
- Former development designation:
SPPx4N60S5/SPBx4N60S5

Product Summary

$V_{DS} @ T_{jmax}$	650	V
$R_{DS(on)}$	1.4	Ω
I_D	3.2	A

P-TO263-3-2

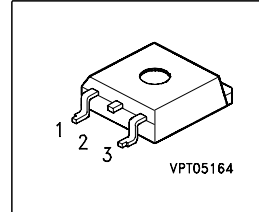

P-TO220-3-1

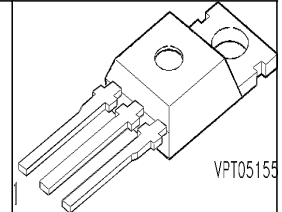

Type	Package	Ordering Code	Marking
SPP03N60S5	P-TO220-3-1	Q67040-S4184	03N60S5
SPB03N60S5	P-TO263-3-2	Q67040-S4197	03N60S5

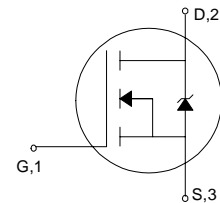

Maximum Ratings, at $T_j = 25^\circ\text{C}$, unless otherwise specified

Parameter	Symbol	Value	Unit
Continuous drain current	I_D		A
$T_C=25^\circ\text{C}$		3.2	
$T_C=100^\circ\text{C}$		2	
Pulsed drain current ¹⁾	$I_{D \text{ puls}}$	5.7	
$T_C=25^\circ\text{C}$			
Avalanche energy, single pulse	E_{AS}	100	mJ
$I_D = 2.56 \text{ A}$, $V_{DD} = 50 \text{ V}$			
Avalanche energy (repetitive, limited by T_{jmax})	E_{AR}	0.2	
$I_D = 3.2 \text{ A}$, $V_{DD} = 50 \text{ V}$			
Avalanche current (repetitive, limited by T_{jmax})	I_{AR}	3.2	A
Reverse diode dv/dt	dv/dt	6	kV/ μs
$I_S=3.2\text{A}$, $V_{DS}<V_{DSS}$, $di/dt=100\text{A}/\mu\text{s}$, $T_{jmax}=150^\circ\text{C}$			
Gate source voltage	V_{GS}	± 20	V
Power dissipation	P_{tot}	38	W
$T_C=25^\circ\text{C}$			
Operating and storage temperature	T_j, T_{stg}	-55... +150	$^\circ\text{C}$

Electrical Characteristics, at $T_j = 25\text{ °C}$, unless otherwise specified

Parameter	Symbol	Values			Unit
		min.	typ.	max.	

Thermal Characteristics

Thermal resistance, junction - case	R_{thJC}	-	-	3.3	K/W
Thermal resistance, junction - ambient (Leaded and through-hole packages)	R_{thJA}	-	-	62	
SMD version, device on PCB: @ min. footprint @ 6 cm ² cooling area ²⁾	R_{thJA}	-	-	62	
		-	35	-	

Static Characteristics, at $T_j = 25\text{ °C}$, unless otherwise specified

Drain-source breakdown voltage $V_{GS} = 0\text{ V}$, $I_D = 0.25\text{ mA}$	$V_{(BR)DSS}$	600	-	-	V
Gate threshold voltage, $V_{GS} = V_{DS}$ $I_D = 135\text{ }\mu\text{A}$, $T_j = 25\text{ °C}$	$V_{GS(th)}$	3.5	4.5	5.5	
Zero gate voltage drain current, $V_{DS} = V_{DSS}$ $V_{GS} = 0\text{ V}$, $T_j = 25\text{ °C}$ $V_{GS} = 0\text{ V}$, $T_j = 150\text{ °C}$	I_{DSS}	-	0.5	1	μA
		-	-	70	
Gate-source leakage current $V_{GS} = 20\text{ V}$, $V_{DS} = 0\text{ V}$	I_{GSS}	-	-	100	nA
Drain-source on-state resistance $V_{GS} = 10\text{ V}$, $I_D = 2\text{ A}$	$R_{DS(on)}$	-	1.26	1.4	Ω

¹ current limited by T_{jmax}

² Device on 40mm*40mm*1.5mm epoxy PCB FR4 with 6 cm² (one layer, 70 μm thick) copper area for drain connection. PCB is vertical without blown air.

Electrical Characteristics, at $T_j = 25\text{ }^\circ\text{C}$, unless otherwise specified

Parameter	Symbol	Conditions	Values			Unit
			min.	typ.	max.	

Dynamic Characteristics

Transconductance	g_{fs}	$V_{DS} \geq 2 \cdot I_D \cdot R_{DS(on)max}$, $I_D = 2\text{A}$	-	1.8	-	S
Input capacitance	C_{iss}	$V_{GS} = 0\text{V}$, $V_{DS} = 25\text{V}$, $f = 1\text{MHz}$	-	420	-	pF
Output capacitance	C_{oss}		-	150	-	
Reverse transfer capacitance	C_{rss}		-	3.6	-	
Turn-on delay time	$t_{d(on)}$	$V_{DD} = 350\text{V}$, $V_{GS} = 10\text{V}$, $I_D = 3.2\text{A}$, $R_G = 20\Omega$	-	35	-	ns
Rise time	t_r		-	25	-	
Turn-off delay time	$t_{d(off)}$		-	40	-	
Fall time	t_f		-	15	22.5	

Gate Charge Characteristics

Gate to source charge	Q_{gs}	$V_{DD} = 350\text{V}$, $I_D = 3.2\text{A}$	-	3.5	-	nC
Gate to drain charge	Q_{gd}		-	7	-	
Total gate charge	Q_g	$V_{DD} = 350\text{V}$, $I_D = 3.2\text{A}$, $V_{GS} = 0$ to 10V	-	12.4	16	

Reverse Diode

Inverse diode continuous forward current	I_S	$T_C = 25\text{ }^\circ\text{C}$	-	-	3.2	A
Inverse diode direct current, pulsed	I_{SM}		-	-	5.7	
Inverse diode forward voltage	V_{SD}	$V_{GS} = 0\text{V}$, $I_F = 3.2\text{A}$	-	1	1.2	V
Reverse recovery time	t_{rr}	$V_R = 350\text{V}$, $I_F = I_S$, $dI_F/dt = 100\text{A}/\mu\text{s}$	-	1000	1700	ns
Reverse recovery charge	Q_{rr}		-	2.3	-	μC

Power dissipation

$$P_{tot} = f(T_C)$$

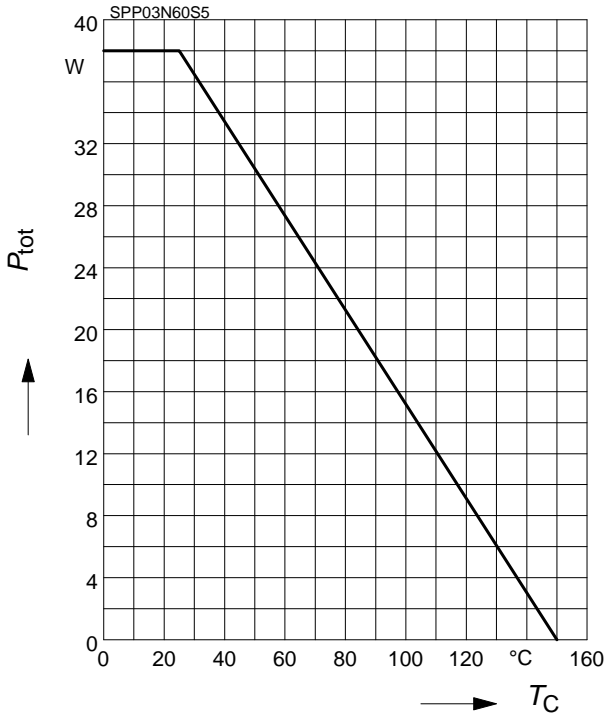

Drain current

$$I_D = f(T_C)$$

parameter: $V_{GS} \geq 10 \text{ V}$

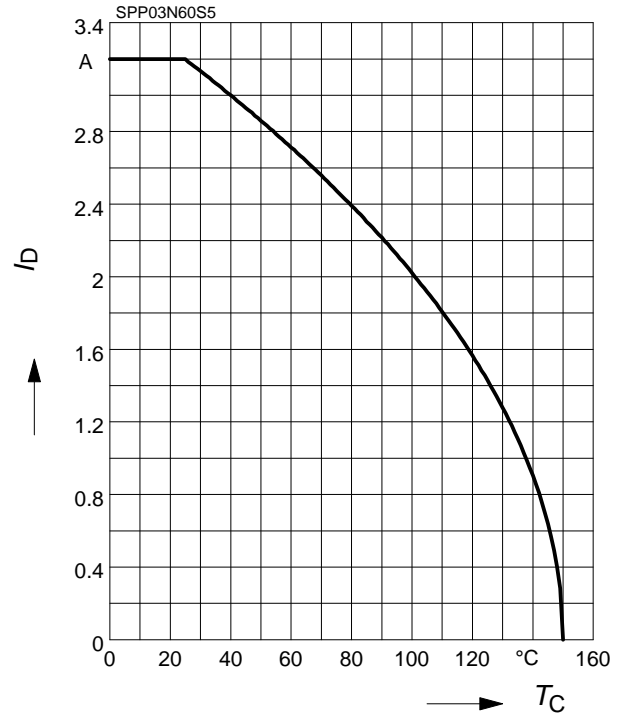

Safe operating area

$$I_D = f(V_{DS})$$

parameter: $D=0.01, T_C=25^\circ\text{C}$

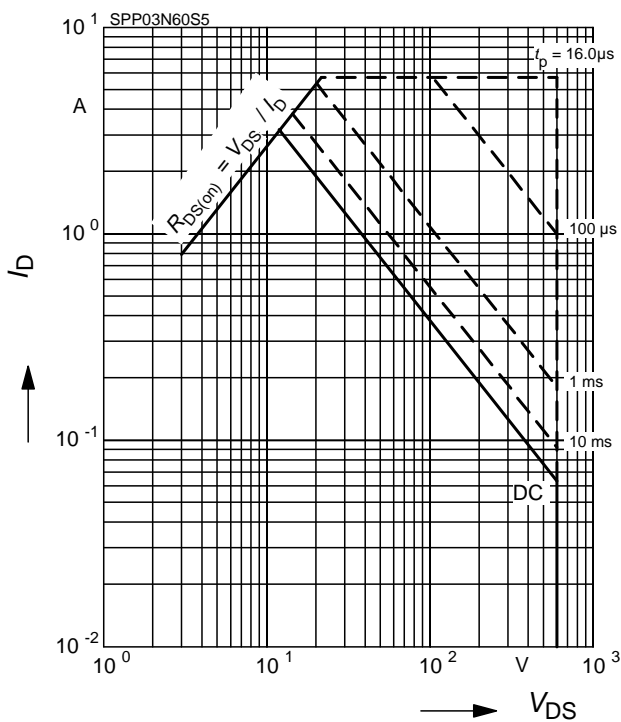

Transient thermal impedance

$$Z_{thJC} = f(t_p)$$

parameter: $D = t_p/T$

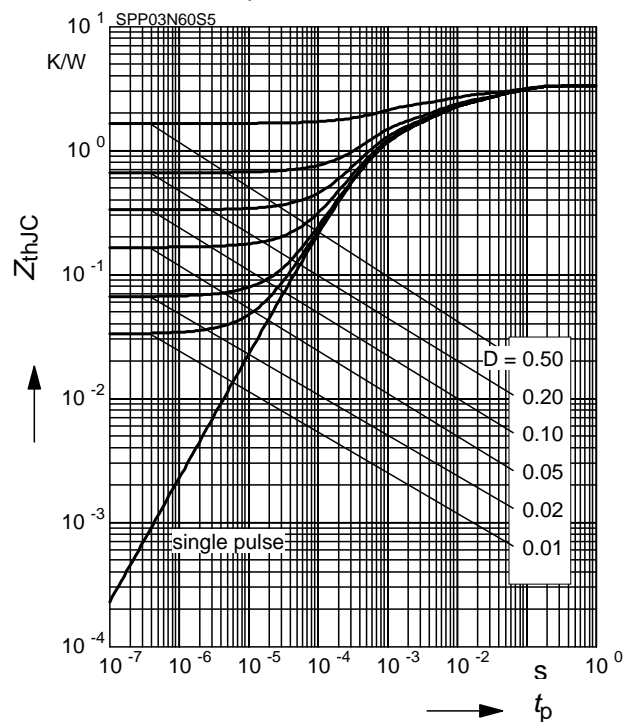

Typ. output characteristic

$I_D = f(V_{DS})$

Parameter: $V_{GS}, T_j = 25\text{ }^\circ\text{C}$

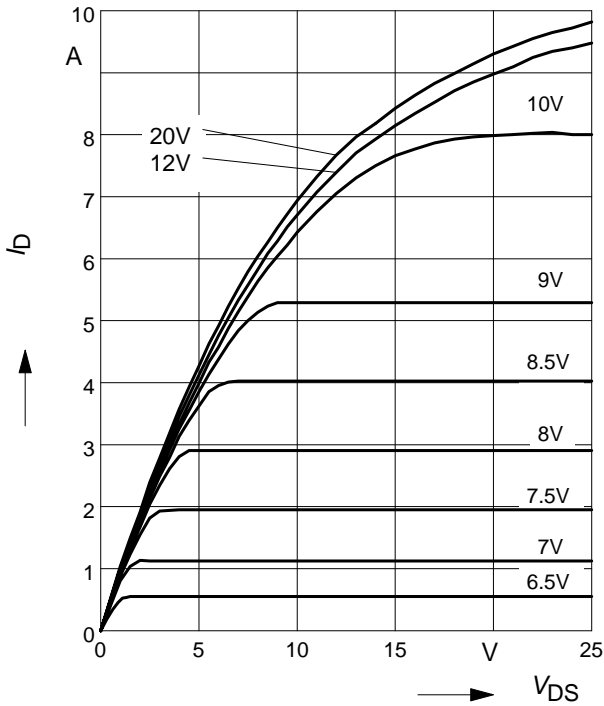

Drain-source on-resistance

$R_{DS(on)} = f(T_j)$

parameter: $I_D = 2\text{ A}, V_{GS} = 10\text{ V}$

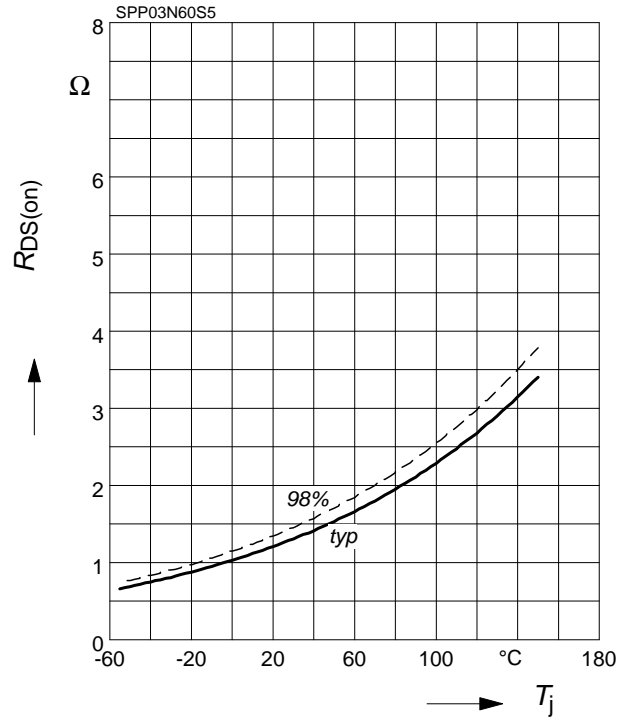

Typ. transfer characteristics

$I_D = f(V_{GS})$

$V_{DS} \geq 2 \times I_D \times R_{DS(on)max}$

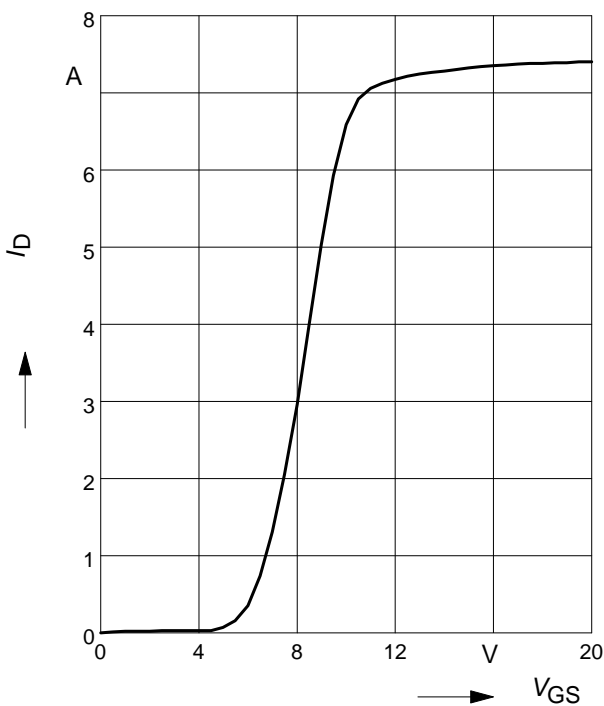

Typ. capacitances

$C = f(V_{DS})$

parameter: $V_{GS} = 0\text{ V}, f = 1\text{ MHz}$

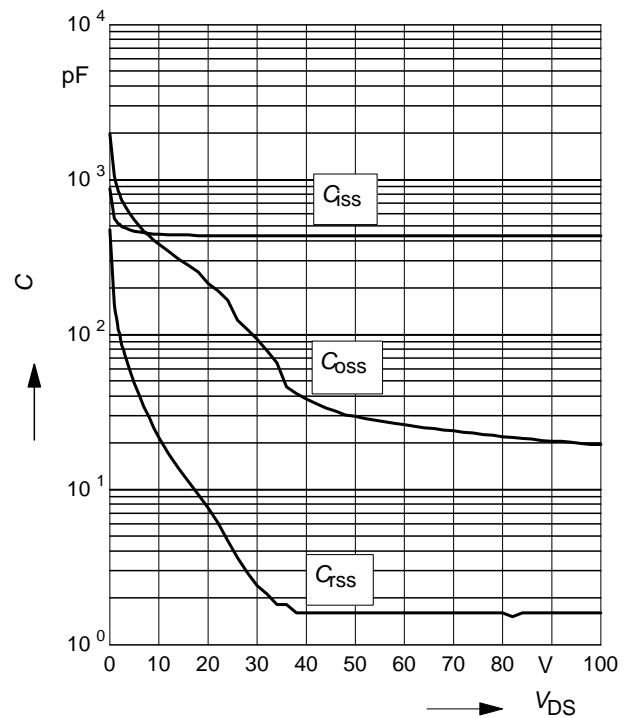

Avalanche energy

$$E_{AS} = f(T_j)$$

par.: $I_D = 2.56A$, $V_{DD} = 50V$

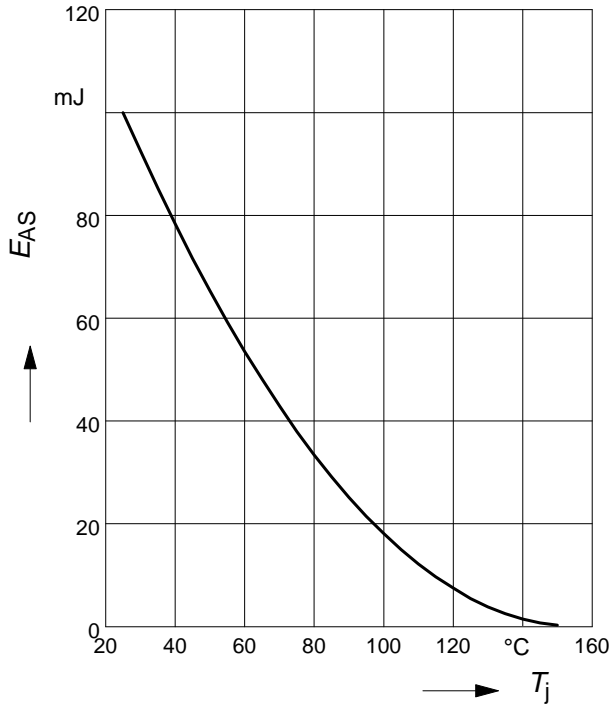

Avalanche SOA

$$I_{AR} = f(t_{AR})$$

par.: $T_j \leq 150\text{ °C}$

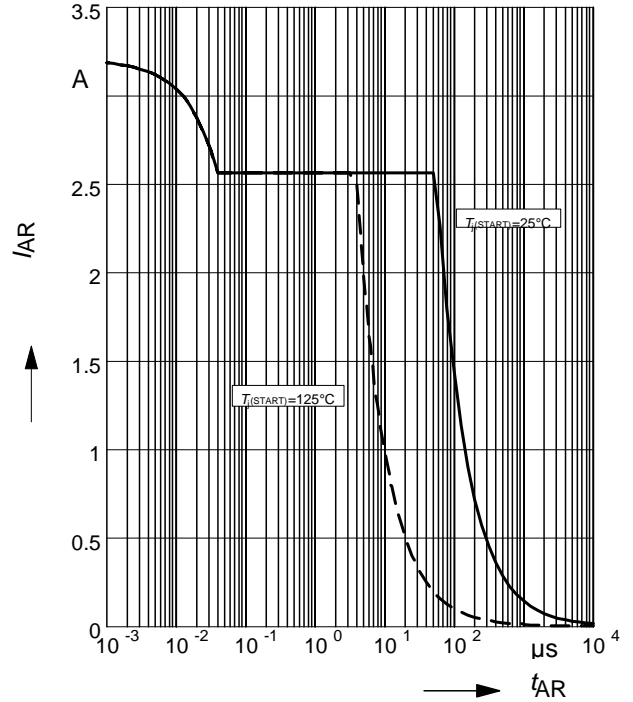

Drain-source breakdown voltage

$$V_{(BR)DSS} = f(T_j)$$

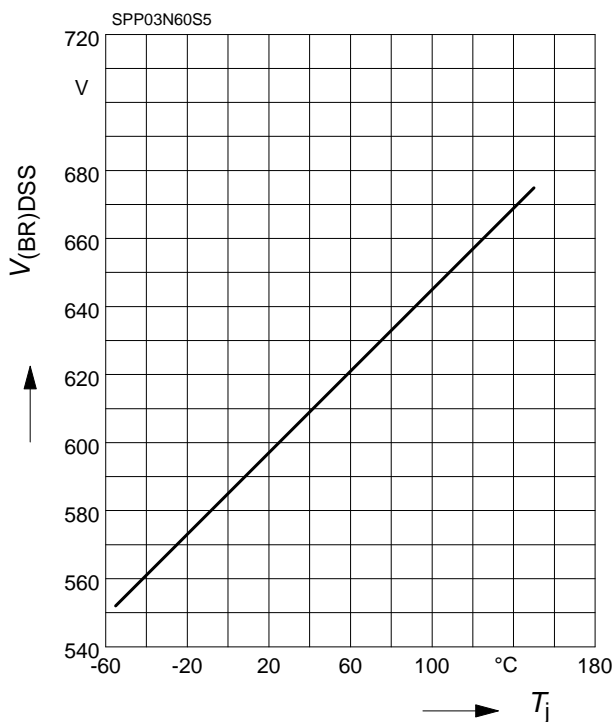

Gate threshold voltage

$$V_{GS(th)} = f(T_j)$$

parameter: $V_{GS} = V_{DS}$, $I_D = 135\text{ }\mu A$

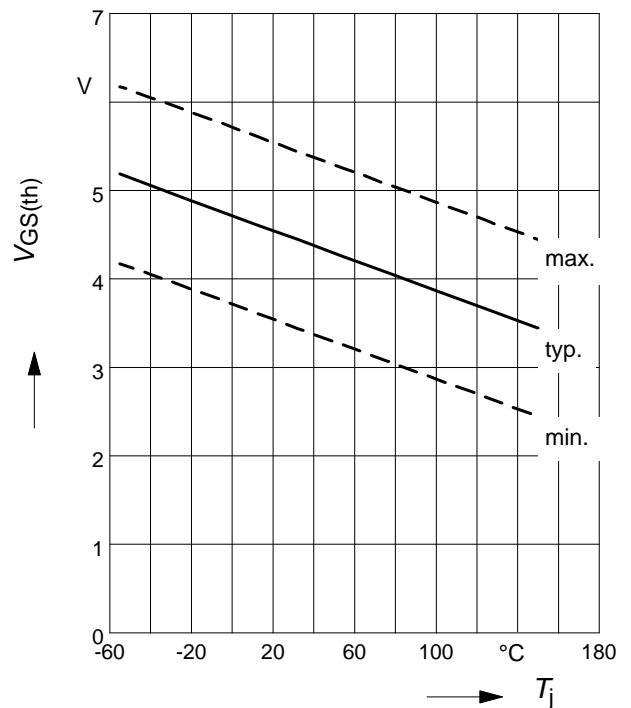

Forward characteristics of reverse diode

$$I_F = f(V_{SD})$$

parameter: T_j , $t_p = 10 \mu s$

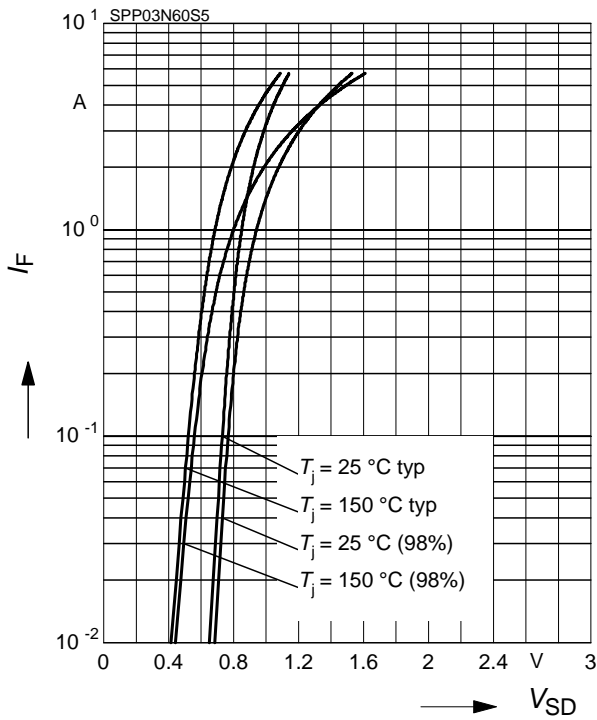

Typ. gate charge

$$V_{GS} = f(Q_{Gate})$$

parameter: $I_{Dpuls} = 3.2 \text{ A}$

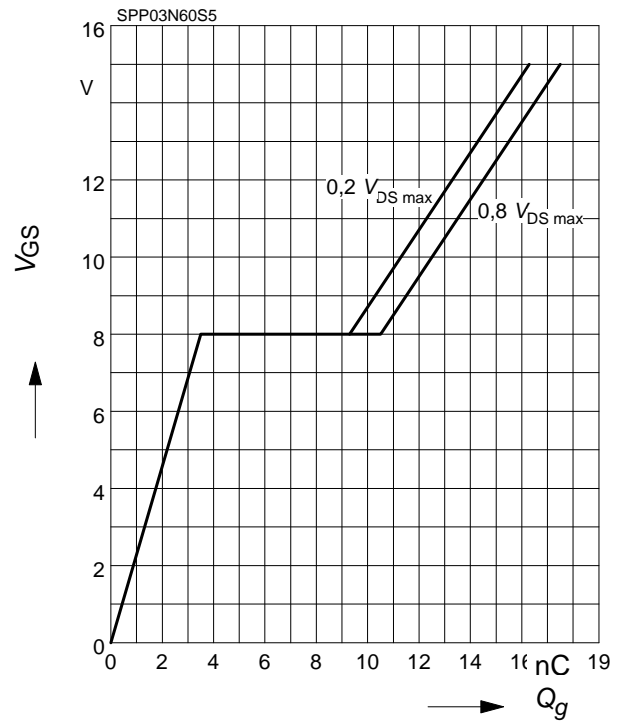

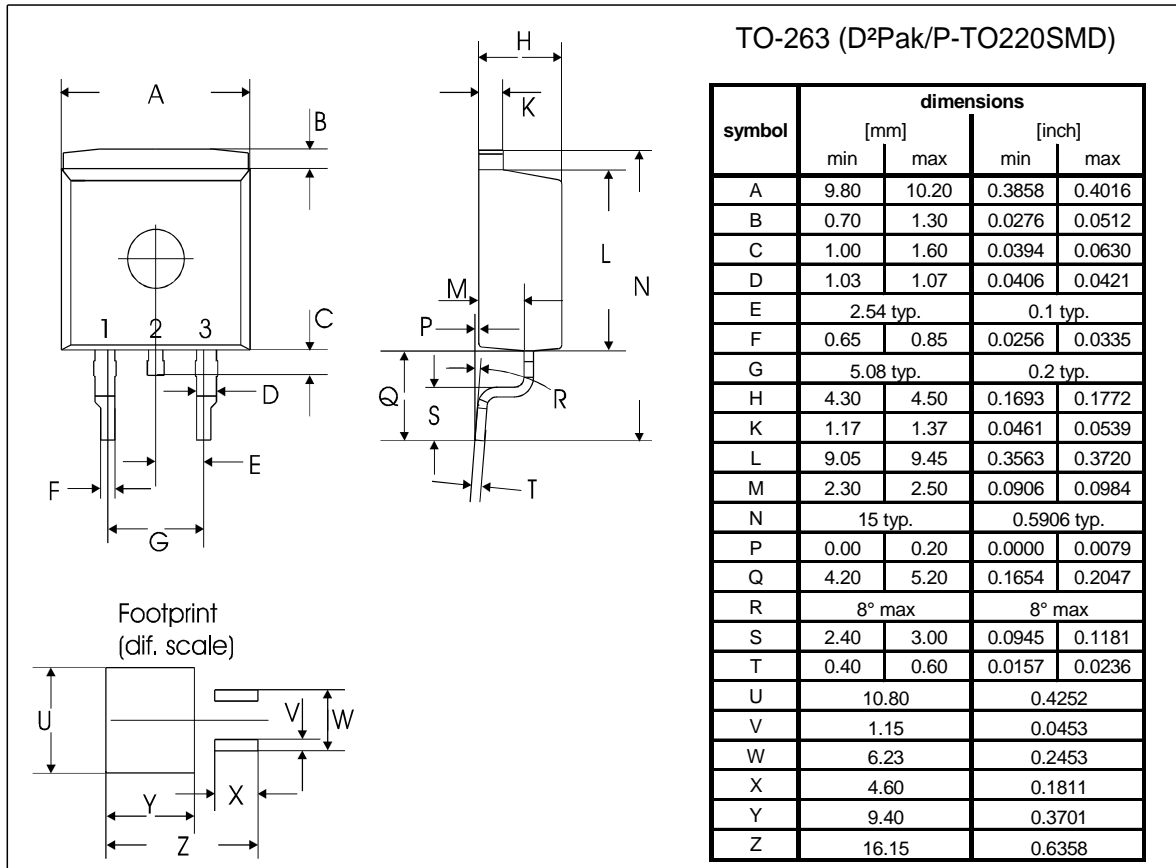
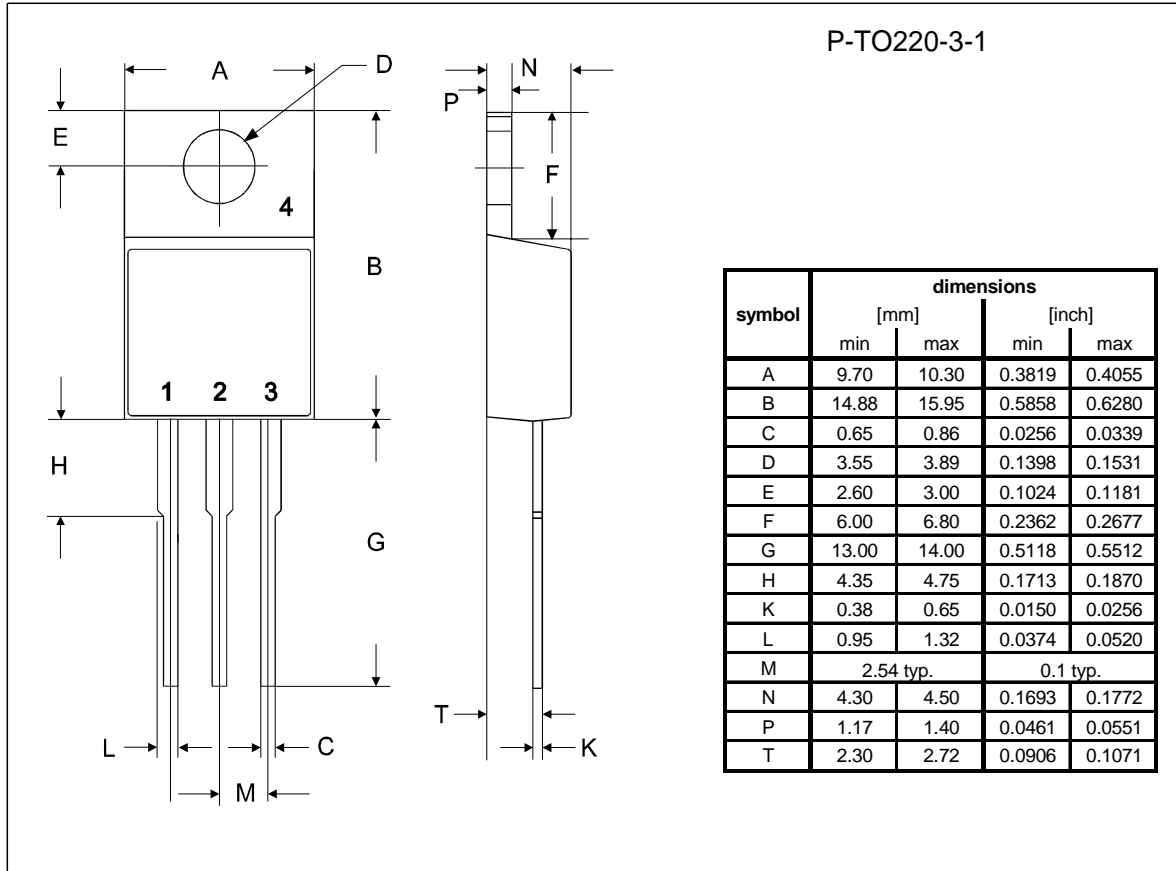

Published by
Infineon Technologies AG,
Bereichs Kommunikation
St.-Martin-Strasse 53,
D-81541 München
© Infineon Technologies AG 1999
All Rights Reserved.

Attention please!

The information herein is given to describe certain components and shall not be considered as warranted characteristics.

Terms of delivery and rights to technical change reserved.

We hereby disclaim any and all warranties, including but not limited to warranties of non-infringement, regarding circuits, descriptions and charts stated herein.

Infineon Technologies is an approved CECC manufacturer.

Information

For further information on technology, delivery terms and conditions and prices please contact your nearest Infineon Technologies Office in Germany or our Infineon Technologies Representatives worldwide (see address list).

Warnings

Due to technical requirements components may contain dangerous substances.

For information on the types in question please contact your nearest Infineon Technologies Office.

Infineon Technologies Components may only be used in life-support devices or systems with the express written approval of Infineon Technologies, if a failure of such components can reasonably be expected to cause the failure of that life-support device or system, or to affect the safety or effectiveness of that device or system. Life support devices or systems are intended to be implanted in the human body, or to support and/or maintain and sustain and/or protect human life. If they fail, it is reasonable to assume that the health of the user or other persons may be endangered.