



**QUICKSWITCH® PRODUCTS**  
**3.3V HIGH SPEED 32-BIT**  
**MULTIWIDTH™ BUS SWITCH**

**IDTQS34XV245**

**FEATURES:**

- 5Ω bidirectional switches connect inputs to outputs
- Pin compatibility with QS3245
- 250ps propagation delay
- Undershoot clamp diodes on all switch and control inputs
- LVTTTL-compatible control inputs
- Available in 80-pin QVSOP package

**APPLICATIONS:**

- 3.3V to 2.5V Voltage translation
- 2.5V to 1.8V Voltage translation
- PCI bus isolation hot swap

**DESCRIPTION:**

The QS34XV245 is a set of 32-bit high speed bus switches controlled by LVTTTL-compatible active low enable signal. When closed, the switches exhibit near zero propagation delay without generating additional ground bounce or switching noise.

The QS34XV245 is specially designed for direct interface between 3.3V and 2.5V devices without any external components. When operating from a 3.3V supply, the logic high level at the switch output is clamped to 2.5V when the switch input signal exceeds 2.5V. This device can be used for switching 2.5V buses without signal attenuation. The ON resistance at 3.3V<sub>VCC</sub> is less than 5Ω typical, providing near zero propagation delay through the switch. Absence of DC path from switch I/O pins to V<sub>CC</sub> or ground makes QS34XV245 an ideal device for hot swapping applications.

The QS34XV245 is characterized for operation from -40°C to +85°C.

**FUNCTIONAL BLOCK DIAGRAM**

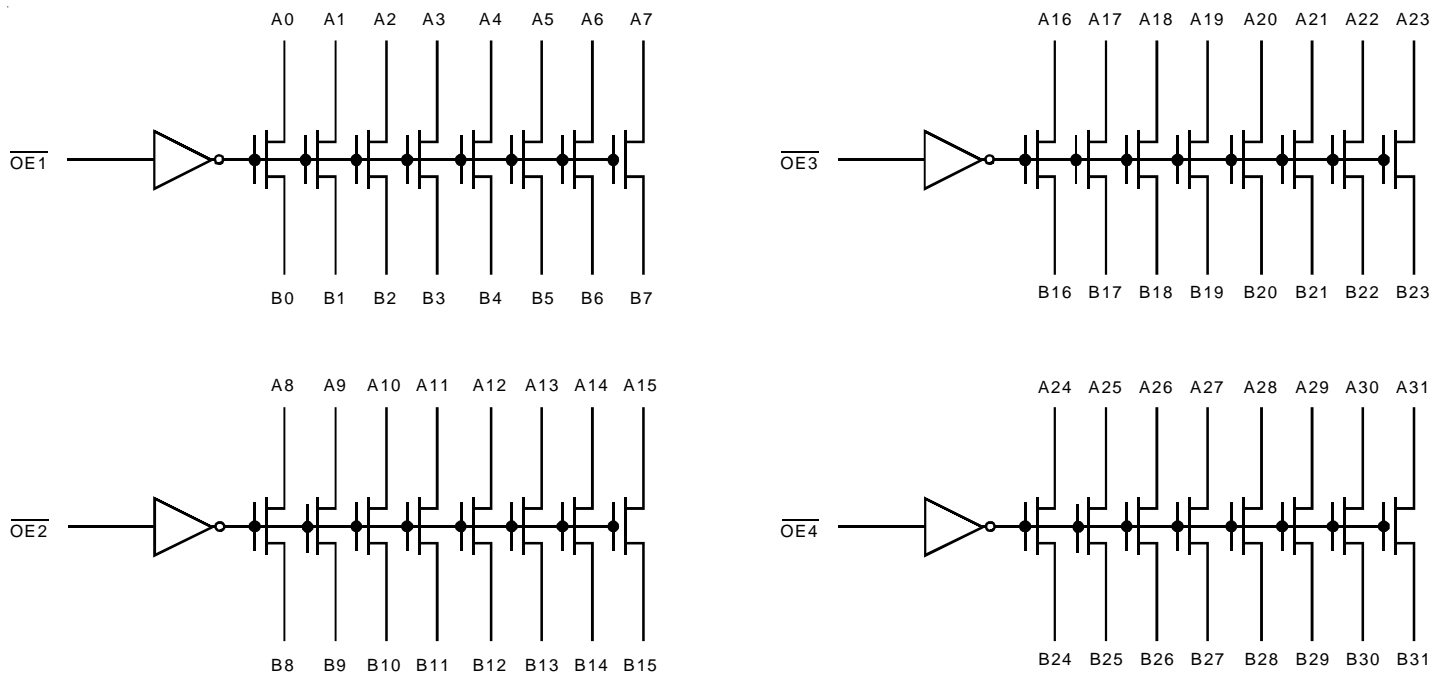

The IDT logo is a registered trademark of Integrated Device Technology, Inc.

## PIN CONFIGURATION

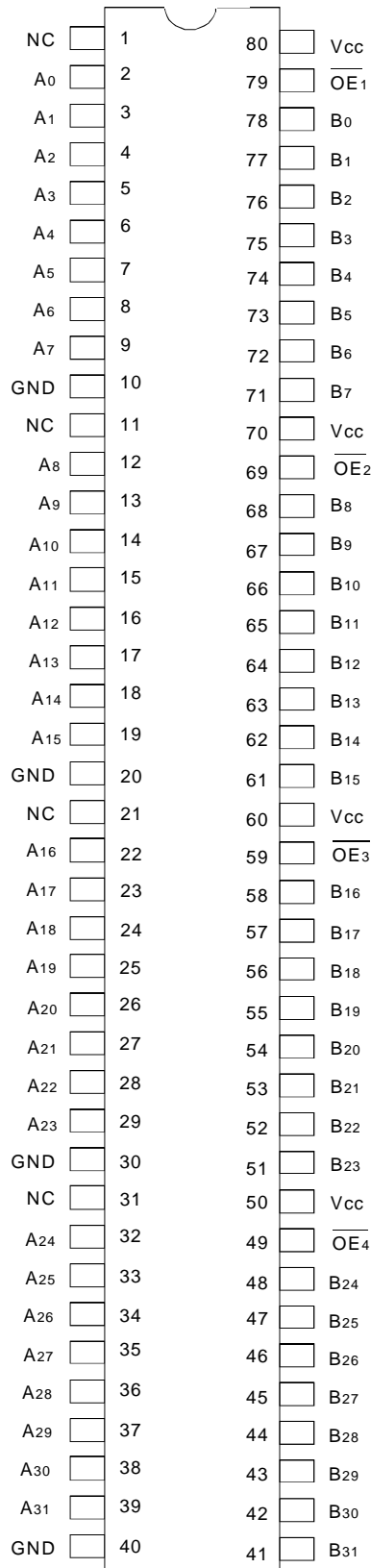

MILLIPAQ  
TOP VIEW

## ABSOLUTE MAXIMUM RATINGS<sup>(1)</sup>

Symbol	Description	Max	Unit
VTERM <sup>(2)</sup>	Supply Voltage to Ground	-0.5 to +4.6	V
VTERM <sup>(3)</sup>	DC Switch Voltage V <sub>s</sub>	-0.5 to +4.6	V
VTERM <sup>(3)</sup>	DC Input Voltage V <sub>IN</sub>	-0.5 to +4.6	V
VAC	AC Input Voltage (pulse width ≤ 20ns)	-3	V
IOUT	DC Output Current	120	mA
P <sub>MAX</sub>	Maximum Power Dissipation (T <sub>A</sub> = 85°C)	0.92	W
TSTG	Storage Temperature	-65 to +150	°C

### NOTE:

- Stresses greater than those listed under ABSOLUTE MAXIMUM RATINGS may cause permanent damage to the device. This is a stress rating only and functional operation of the device at these or any other conditions above those indicated in the operational sections of this specification is not implied. Exposure to absolute maximum rating conditions for extended periods may affect reliability.
- V<sub>CC</sub> terminals.
- All terminals except V<sub>CC</sub>.

## CAPACITANCE

(T<sub>A</sub> = +25°C, f = 1.0MHz, V<sub>IN</sub> = 0V, V<sub>OUT</sub> = 0V)

Pins	Typ.	Max. <sup>(1)</sup>	Unit
Control Pins	4	6	pF
Quickswitch Channels (Switch OFF)	5	7	pF

### NOTE:

- This parameter is measured at characterization but not tested.

## PIN DESCRIPTION

Pin Names	Description
$\overline{OE}$	Output Enable
A <sub>n</sub> , B <sub>n</sub>	Data I/Os

## FUNCTION TABLE<sup>(1)</sup>

$\overline{OE}_n$	Function
H	Disconnected
L	A <sub>n</sub> = B <sub>n</sub>

### NOTE:

- H = HIGH Voltage Level  
L = LOW Voltage Level

## DC ELECTRICAL CHARACTERISTICS OVER OPERATING RANGE

Following Conditions Apply Unless Otherwise Specified:

Industrial:  $T_A = -40^{\circ}\text{C}$  to  $+85^{\circ}\text{C}$ ,  $V_{CC} = 3.3\text{V} \pm 0.3\text{V}$

Symbol	Parameter	Test Conditions	Min.	Typ. <sup>(1)</sup>	Max.	Unit
$V_{IH}$	Input HIGH Level	Guaranteed Logic HIGH for Control Pins	2	—	—	V
$V_{IL}$	Input LOW Level	Guaranteed Logic LOW for Control Pins	—	—	0.8	V
$I_{IN}$	Input Leakage Current (Control Inputs)	$0\text{V} \leq V_{IN} \leq V_{CC}$	—	—	1	$\mu\text{A}$
$I_{OZ}$	Off-State Output Current (Hi-Z)	$0\text{V} \leq V_{OUT} \leq V_{CC}$ , Switches OFF	—	0.001	1	$\mu\text{A}$
$R_{ON}$	Switch ON Resistance	$V_{CC} = \text{Min.}$ , $V_{IN} = 0\text{V}$ , $I_{ON} = 8\text{mA}$	—	5	7	$\Omega$
		$V_{CC} = \text{Min.}$ , $V_{IN} = 1.7\text{V}$ , $I_{ON} = 8\text{mA}$	—	15	20	
		$V_{CC} = 2.3\text{V}$ , $V_{IN} = 0\text{V}$ , $I_{ON} = 8\text{mA}$	—	7	—	
		$V_{CC} = 2.3\text{V}$ , $V_{IN} = 1.3\text{V}$ , $I_{ON} = 8\text{mA}$	—	25	—	
$V_P$	Pass Voltage <sup>(2)</sup>	$V_{IN} = V_{CC} = 3.3\text{V}$ , $I_{OUT} = -5\mu\text{A}$	2.5	2.7	2.9	V
		$V_{IN} = V_{CC} = 2.5\text{V}$ , $I_{OUT} = -5\mu\text{A}$	—	1.8	—	

### NOTES:

1. Typical values are at  $V_{CC} = 3.3\text{V}$ ,  $T_A = 25^{\circ}\text{C}$ .
2. Pass Voltage is guaranteed but not production tested.

## POWER SUPPLY CHARACTERISTICS

Symbol	Parameter	Test Conditions <sup>(1)</sup>	Max.	Unit
$I_{CCQ}$	Quiescent Power Supply Current	$V_{CC} = \text{Max.}$ , $V_{IN} = \text{GND}$ or $V_{CC}$ , $f = 0$	12	$\mu\text{A}$
$\Delta I_{CC}$	Power Supply Current per Control Input HIGH <sup>(2)</sup>	$V_{CC} = \text{Max.}$ , $V_{IN} = 3\text{V}$ or $V_{CC}$ , $f = 0$	50	$\mu\text{A}$
$I_{CCD}$	Dynamic Power Supply Current per MHz <sup>(3)</sup>	$V_{CC} = \text{Max.}$ , A and B pins open Control Inputs Toggling at 50% Duty Cycle	0.15	$\text{mA}/\text{MHz}$

### NOTES:

1. For conditions shown as Min. or Max., use the appropriate values specified under DC Electrical Characteristics.
2. Per TLL driven input ( $V_{IN} = 3.4\text{V}$ , control inputs only). A and B pins do not contribute to  $\Delta I_{CC}$ .
3. This current applies to the control inputs only and represents the current required to switch internal capacitance at the specified frequency. The A and B inputs generate no significant AC or DC currents as they transition. This parameter is guaranteed but not production tested.

## SWITCHING CHARACTERISTICS OVER OPERATING RANGE

$T_A = -40^{\circ}\text{C}$  to  $+85^{\circ}\text{C}$ ,  $V_{CC} = 3.3\text{V} \pm 0.3\text{V}$ ;

$C_{LOAD} = 50\text{pF}$ ,  $R_{LOAD} = 500\Omega$  unless otherwise noted.

Symbol	Parameter	Min. <sup>(1)</sup>	Typ.	Max.	Unit
t <sub>PLH</sub>	Data Propagation Delay <sup>(2,3)</sup>	—	—	0.25	ns
t <sub>PHL</sub>	An to/from Bn				
t <sub>PZL</sub>	Switch Turn-on Delay	0.5	—	6.5	ns
t <sub>PZH</sub>	$\overline{\text{OEn}}$ to An/Bn				
t <sub>PLZ</sub>	Switch Turn-off Delay <sup>(2)</sup>	0.5	—	4	ns
t <sub>PHZ</sub>	$\overline{\text{OEn}}$ to An/Bn				

**NOTES:**

1. Minimums are guaranteed but not production tested.
2. This parameter is guaranteed but not production tested.
3. The bus switch contributes no propagation delay other than the RC delay of the ON resistance of the switch and the load capacitance. The time constant for the switch alone is of the order of 0.25ns for  $C_L = 30\text{pF}$ . Since this time constant is much smaller than the rise and fall times of typical driving signals, it adds very little propagation delay to the system. Propagation delay of the bus switch, when used in a system, is determined by the driving circuit on the driving side of the switch and its interaction with the load on the driven side.

### TYPICAL ON RESISTANCE vs $V_{IN}$ AT $V_{CC} = 3.3\text{V}$

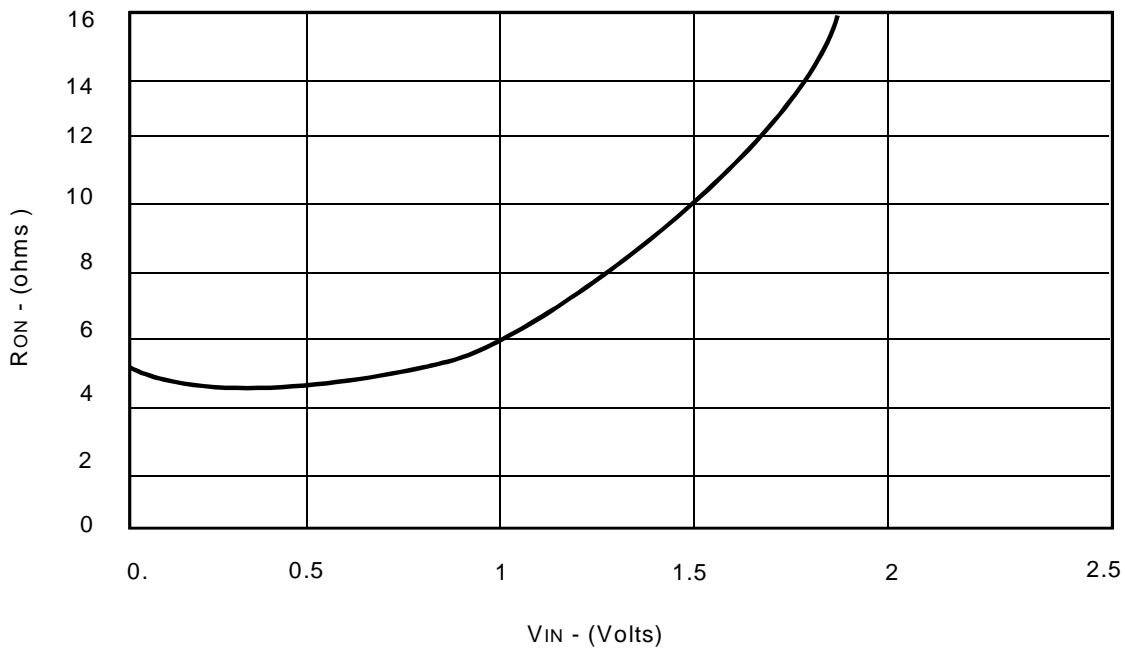

### OUTPUT VI CHARACTERISTICS

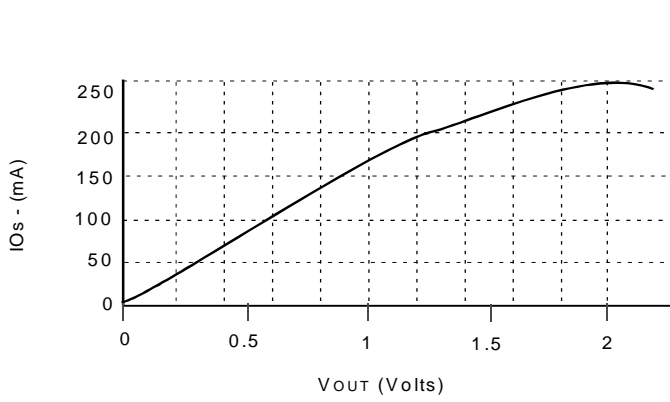

*Outputs Low Characteristic*

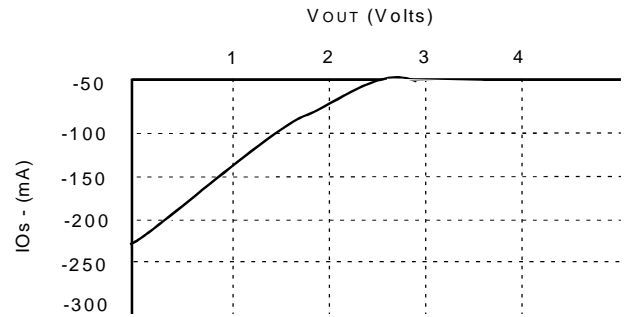

*Outputs High Characteristic*

### PASS VOLTAGE vs Vcc

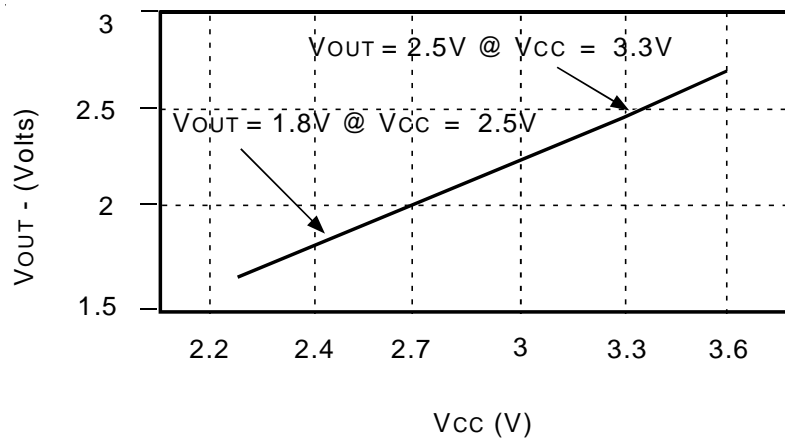

### 3.3V TO 2.5V VOLTAGE TRANSLATION

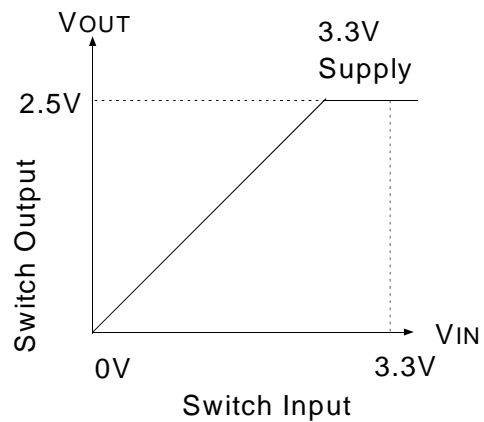
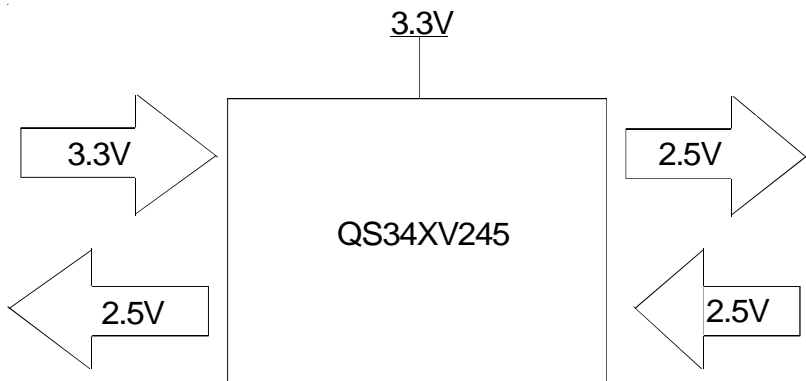

### 2.5V TO 1.8V VOLTAGE TRANSLATION

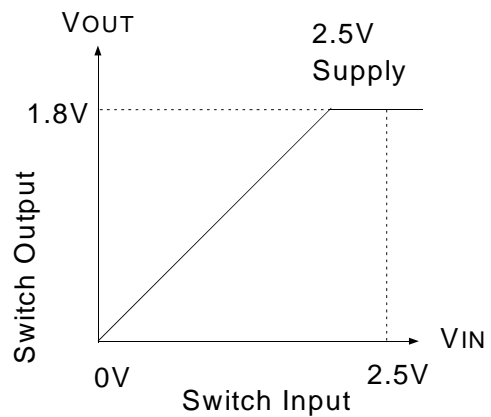
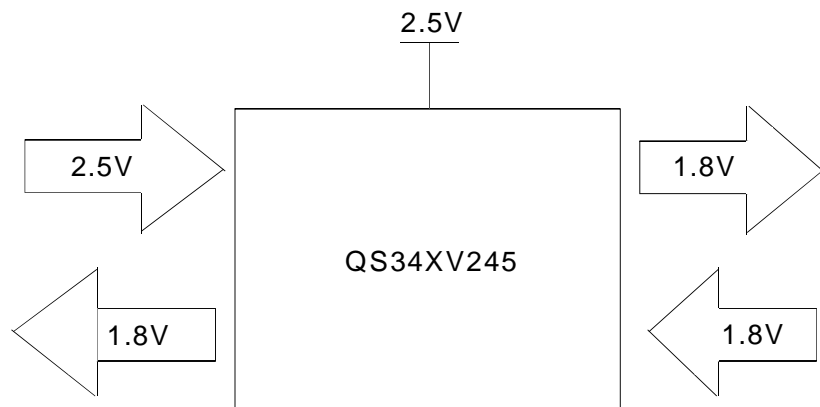

## ORDERING INFORMATION

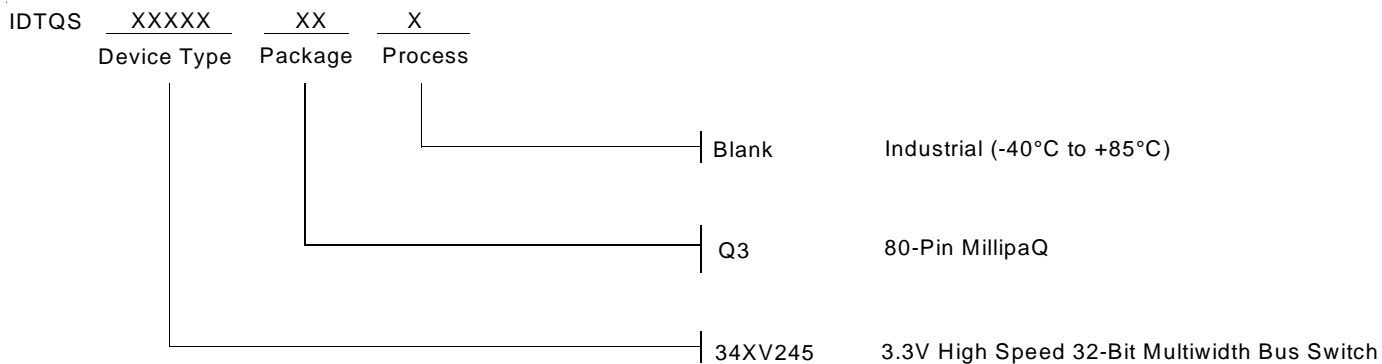

**CORPORATE HEADQUARTERS**  
2975 Stender Way  
Santa Clara, CA 95054

**for SALES:**  
800-345-7015 or 408-727-6116  
fax: 408-492-8674  
www.idt.com

**for Tech Support:**  
logichelp@idt.com  
(408) 654-6459