

GaAs MMIC I/Q MIXER MODULE 4.0 - 8.5 GHz



Typical Applications

The HMC-C009 is ideal for:

- Telecommunications Equipment
- Test Equipment
- Military Radios, Radar & ECM
- Space Systems

Functional Diagram

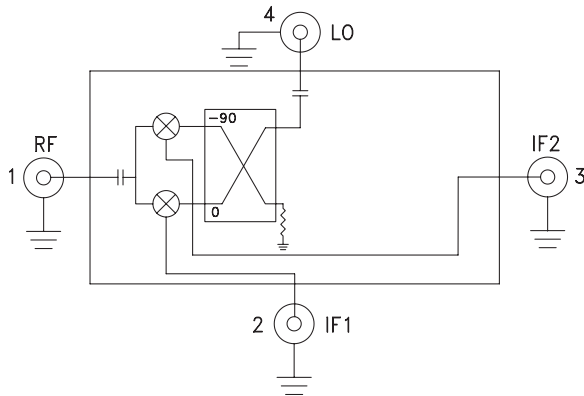

Features

- Wide IF Bandwidth: DC - 3.5 GHz
- Image Rejection: 35 dB
- LO to RF Isolation: 40 dB
- High Input IP3: +23 dBm
- Hermetically Sealed Module
- Field Replaceable SMA Connectors
- 55 to +85 °C Operating Temperature

General Description

The HMC-C009 is a passive I/Q MMIC mixer housed in a miniature hermetic module which can be used as either an Image Reject Mixer or a Single Sideband Upconverter. The module utilizes two standard Hittite double balanced mixer cells and a 90 degree hybrid fabricated on a GaAs MESFET process. This MMIC based module is a more reliable and consistent alternative to hybrid style I/Q Mixers and Single Sideband Converter assemblies. The module features removable SMA connectors which can be detached to allow direct connection of the modules I/O pins to a microstrip or coplanar circuit.

Electrical Specifications, $T_A = +25^\circ \text{C}$, $IF = 100 \text{ MHz}$, $LO = +15 \text{ dBm}^*$

Parameter	Min.	Typ.	Max.	Min.	Typ.	Max.	Units
Frequency Range, RF/LO		4.0 - 8.5			5.5 - 7.5		GHz
Frequency Range, IF		DC - 3.5			DC - 3.5		GHz
Conversion Loss (As IRM)		7.5	10.5		7.5	9.5	dB
Image Rejection	22	35		28	34		dB
1 dB Compression (Input)		+14			+15		dBm
LO to RF Isolation	32	40		35	40		dB
LO to IF Isolation	14	20		15	20		dB
IP3 (Input)		+23			+23		dBm
Amplitude Balance		0.3			0.2		dB
Phase Balance		8			6		Deg

* Unless otherwise noted, all measurements performed as downconverter.

**GaAs MMIC I/Q MIXER MODULE
4.0 - 8.5 GHz**

Data taken As IRM With External IF Hybrid

Conversion Gain vs. Temperature

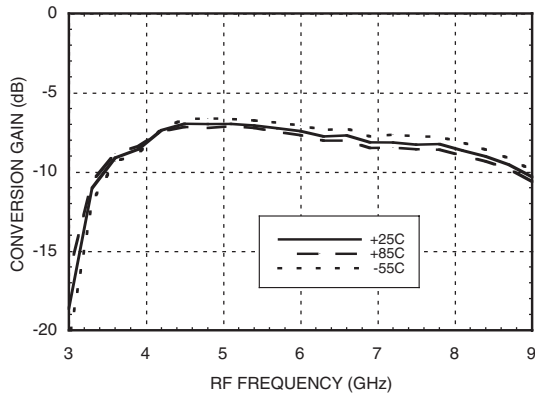
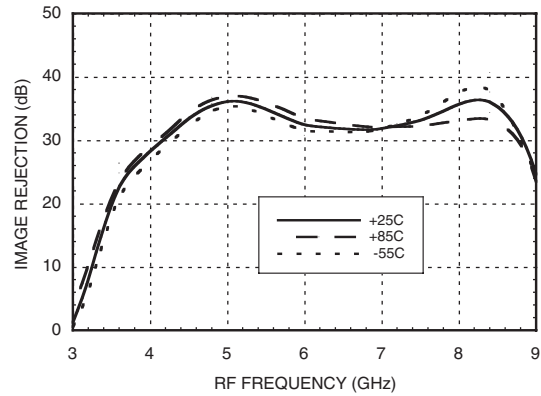
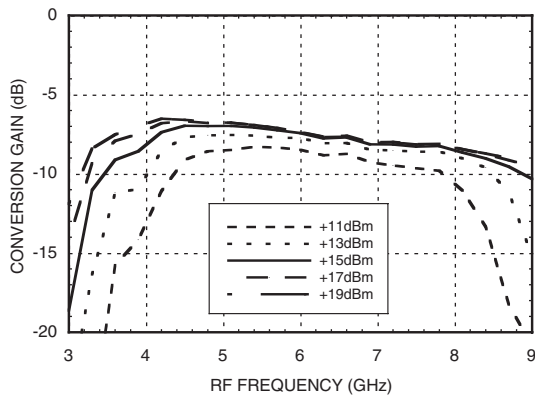

Image Rejection vs. Temperature



Conversion Gain vs. LO Drive



Return Loss

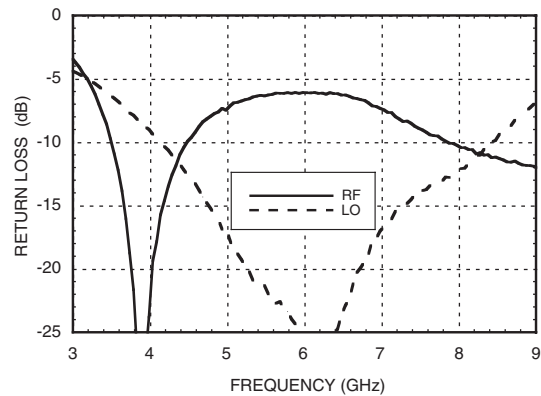

Input P1dB vs. Temperature

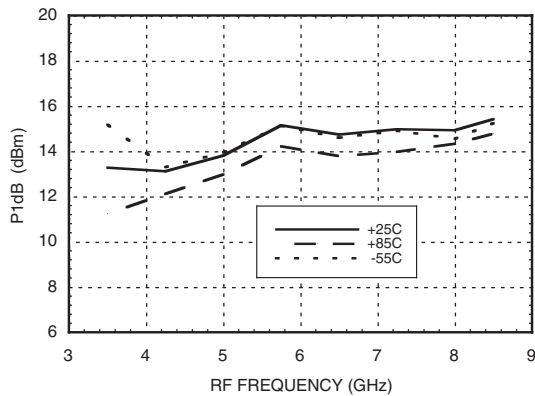

Input IP3 vs. LO Drive

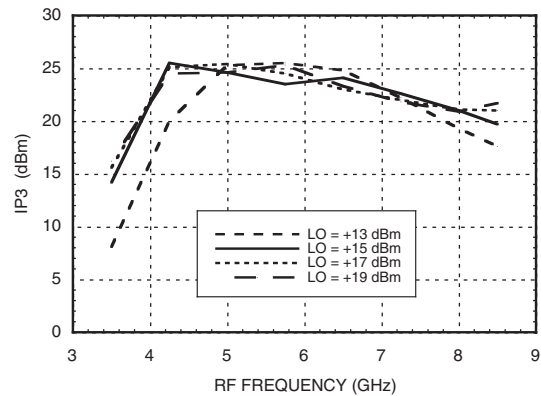

Quadrature Channel Data Taken Without IF Hybrid

Isolations

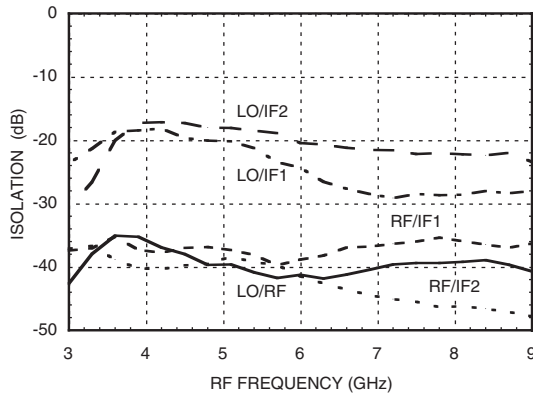

IF Bandwidth*

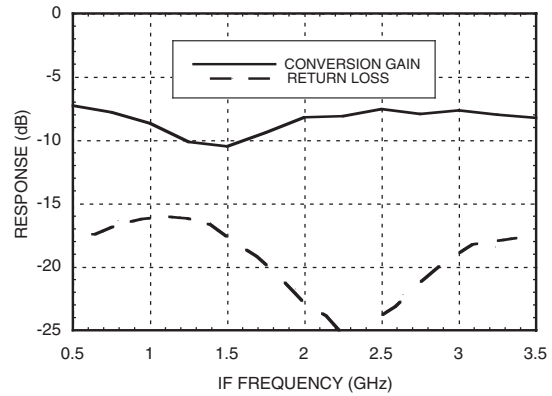

Amplitude Balance vs. LO Drive

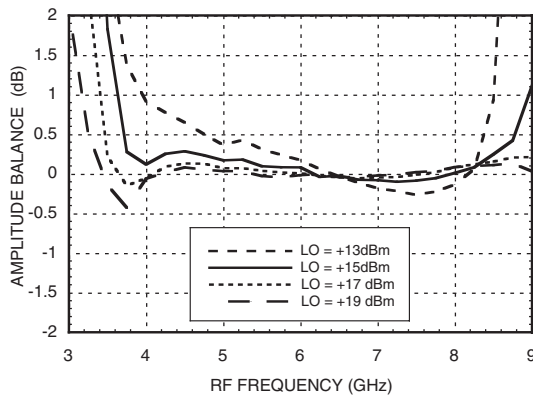

Phase Balance vs. LO Drive

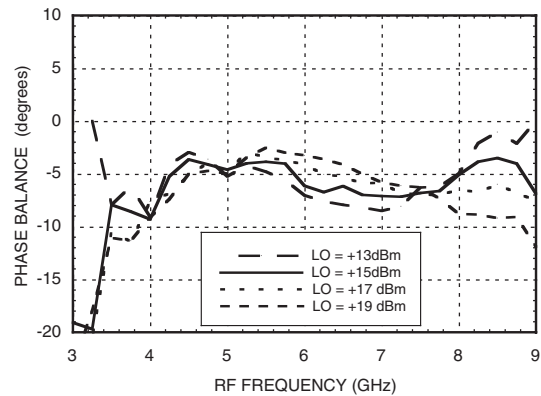

Upconverter Performance Conversion Gain vs. LO Drive*

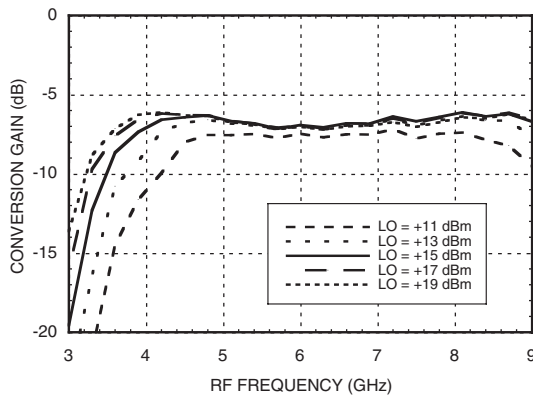

Upconverter Performance Sideband Rejection vs. LO Drive*

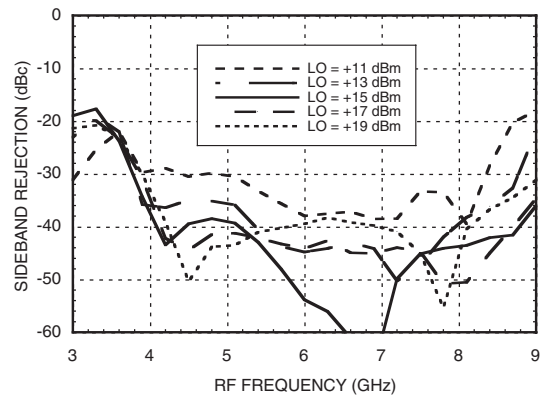

* Conversion gain data taken with external IF hybrid

Harmonics of LO

LO Freq. (GHz)	nLO Spur at RF Port			
	1	2	3	4
3.5	41	54	59	57
4.5	43	43	59	58
5.5	46	57	52	71
6.5	44	60	71	60
7.5	43	66	69	62
8.5	44	65	69	70

LO = +15 dBm
Values in dBc below input LO level measured at RF Port.
Data taken with IF ports terminated in 50 Ohms.

MxN Spurious Outputs

mRF	nLO				
	0	1	2	3	4
0	xx	10	35	25	51
1	35	0	45	54	74
2	94	64	72	67	95
3	95	97	99	84	97
4	90	93	95	97	106

RF = 5.6 GHz @ -10 dBm
LO = 5.5 GHz @ +15 dBm
Data taken without IF hybrid
All values in dBc below IF power level

Absolute Maximum Ratings

RF / IF Input	+20 dBm
LO Drive	+27 dBm
Storage Temperature	-65 to +150 °C
Operating Temperature	-55 to +85 deg °C



**ELECTROSTATIC SENSITIVE DEVICE
OBSERVE HANDLING PRECAUTIONS**

GaAs MMIC I/Q MIXER MODULE
4.0 - 8.5 GHz

Outline Drawing

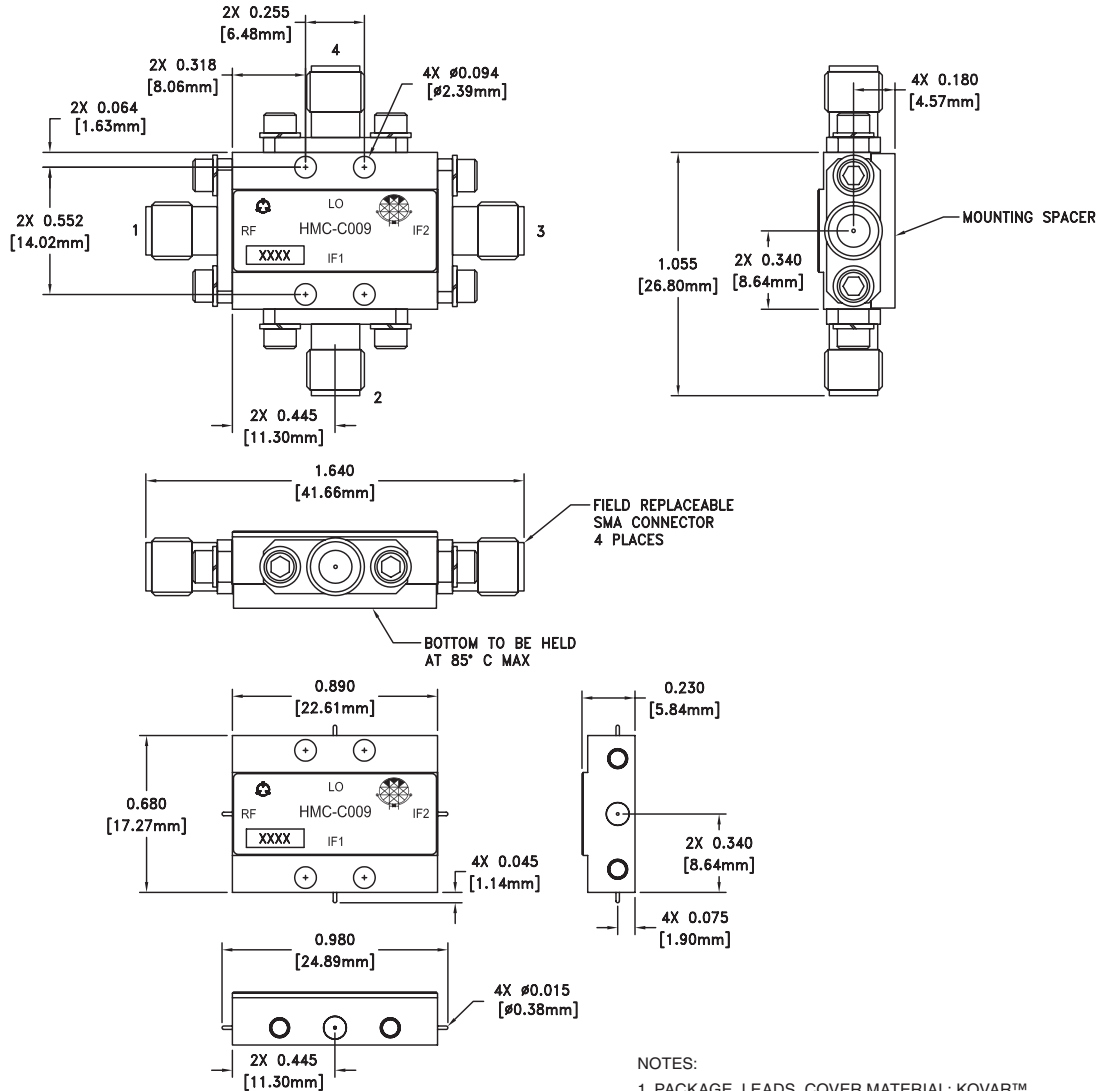

NOTES:

1. PACKAGE, LEADS, COVER MATERIAL: KOVARTM
2. SPACER MATERIAL: ALUMINUM
3. PLATING: ELECTROLYTIC GOLD 50 MICROINCHES MIN., OVER ELECTROLYTIC NICKEL 75 MICROINCHES MIN.
4. ALL DIMENSIONS ARE IN INCHES [MILLIMETERS].
5. TOLERANCES \pm .005 [0.13] UNLESS OTHERWISE SPECIFIED.
6. FIELD REPLACEABLE SMA CONNECTORS. TENSOLITE 5602-5CCSF OR EQUIVALENT.

Pin Descriptions

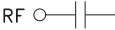
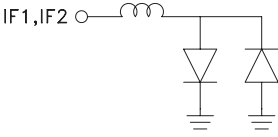
Pin Number	Function	Description	Interface Schematic
1	RF	This pin is AC coupled and matched to 50 Ohms from 4 to 8.5 GHz.	RF 
2	IF1	This pin is DC coupled. For applications not requiring operation to DC, this port should be DC blocked externally using a series capacitor whose value has been chosen to pass the necessary IF frequency range. For operation to DC, this pin must not source/sink more than 3mA of current or part non-function and possible part failure will result.	IF1,IF2 
3	IF2		
4	LO	This pin is AC coupled and matched to 50 Ohms from 4 to 8.5 GHz.	LO 