



0.5 dB LSB GaAs MMIC 5-BIT DIGITAL POSITIVE CONTROL ATTENUATOR, 0.7 - 3.8 GHz

Typical Applications

The HMC603QS16 / HMC603QS16E is ideal for:

- Cellular/3G Infrastructure
- ISM, MMDS
- WLAN, WiMAX, & WiBro

Features

- 0.5 dB LSB Steps to 15.5 dB
- Single Positive Control Per Bit
- ± 0.15 dB Typical Bit Error
- High Input IP3: +50 dBm
- QSOP16 SMT Package

Functional Diagram

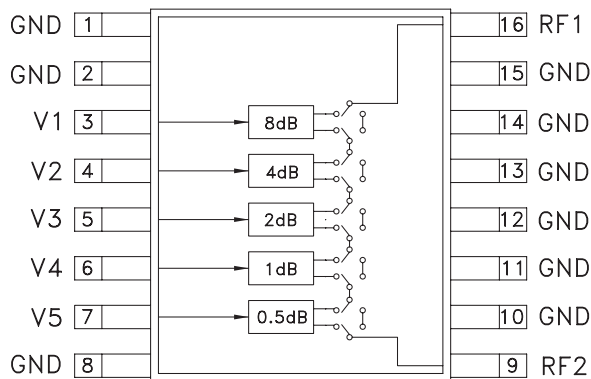

General Description

The HMC603QS16 & HMC603QS16E are general purpose broadband 5-bit positive control GaAs IC digital attenuators in 16 lead QSOP surface mount plastic packages. Covering 0.7 to 3.8 GHz, the insertion loss is less than 1.9 dB typical. The attenuator bit values are 0.5 (LSB), 1, 2, 4 and 8 dB for a total attenuation of 15.5 dB. Attenuation accuracy is excellent at ± 0.15 dB typical with an IIP3 of +50 dBm. Five bit control voltage inputs, toggled between 0 and +3 to +5V, are used to select each attenuation state at less than 1 uA each. A single Vdd bias of +3 to +5V applied through an external 5K Ohm resistor is required.

Electrical Specifications,

$T_A = +25^\circ C$, $V_{dd} = +3V$ to $+5V$ & $V_{ctl} = 0/V_{dd}$ (Unless Otherwise Stated)

| Parameter | Frequency (GHz) | Min. | Typical | Max. | Units |
|---|-----------------|----------------------------------|--|------|---------|
| Insertion Loss | 0.7 - 1.4 GHz | | 1.3 | 1.6 | dB |
| | 1.4 - 2.3 GHz | | 1.6 | 1.9 | dB |
| | 2.3 - 3.0 GHz | | 1.9 | 2.2 | dB |
| | 3.0 - 3.8 GHz | | 2.6 | 3.0 | dB |
| Attenuation Range | | | 15.5 | | dB |
| Return Loss (RF1 & RF2, All Atten. States) | 0.7 - 1.4 GHz | | 18 | | dB |
| | 1.4 - 3.0 GHz | | 20 | | dB |
| | 3.0 - 3.8 GHz | | 15 | | dB |
| Attenuation Accuracy: (Referenced to Insertion Loss) | All States | 0.7 - 2.2 GHz | $\pm (0.2 + 2\% \text{ of Atten. Setting}) \text{ Max.}$ | | dB |
| | | 2.2 - 3.8 GHz | $\pm (0.3 + 3\% \text{ of Atten. Setting}) \text{ Max.}$ | | dB |
| Input Power for 0.1 dB Compression | 0.7 - 3.8 GHz | $V_{dd} = 5V$ | 29 | | dBm |
| | | $V_{dd} = 3V$ | 28 | | dBm |
| Input Third Order Intercept Point (Two-tone Input Power = 0 dBm Each Tone) | 0.7 - 3.8 GHz | REF - 2 dB States | 53 | | dBm |
| | | 2.5 - 15.5 dB States | 48 | | dBm |
| Switching Characteristics | 0.7 - 3.8 GHz | tRISE, tFALL (10/90% RF) | 1.6 | | μs |
| | | tON, tOFF (50% CTL to 10/90% RF) | 1.6 | | μs |



0.5 dB LSB GaAs MMIC 5-BIT DIGITAL POSITIVE CONTROL ATTENUATOR, 0.7 - 3.8 GHz

Insertion Loss

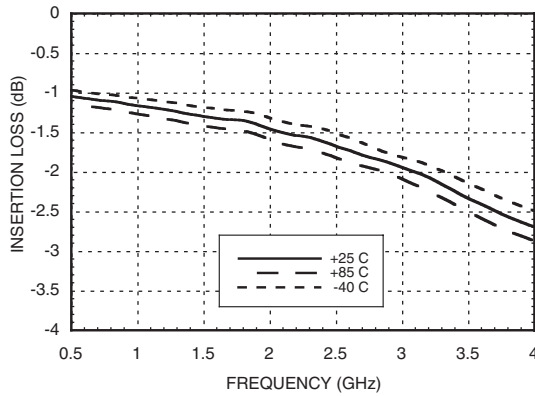

Return Loss RF1, RF2 (Only Major States are Shown)

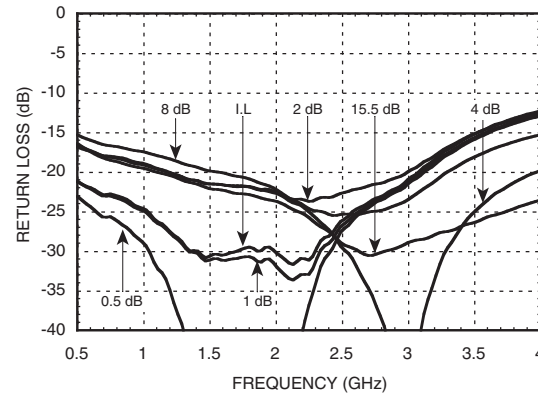

Normalized Attenuation (Only Major States are Shown)

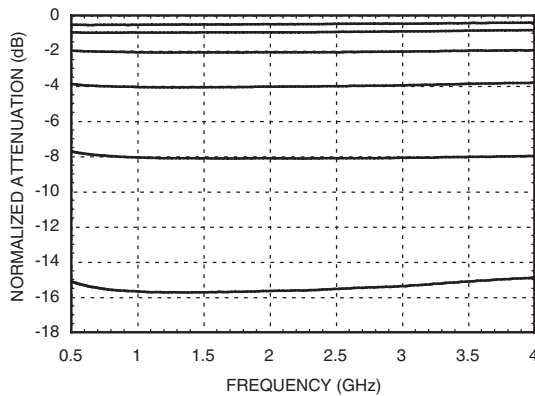

Bit Error vs. Attenuation State

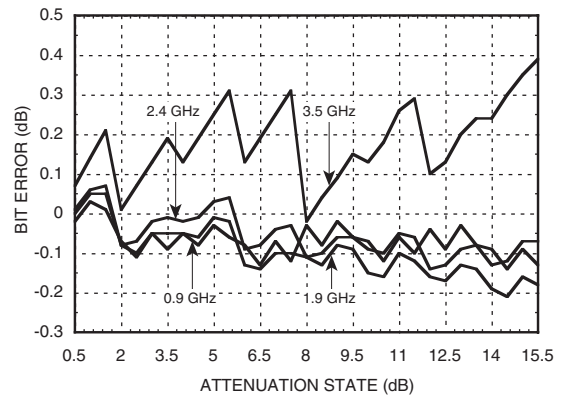

Bit Error vs. Frequency (Only Major States are Shown)

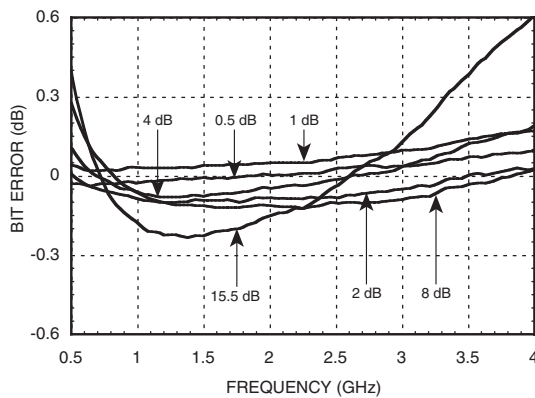

Relative Phase vs. Frequency (Only Major States are Shown)

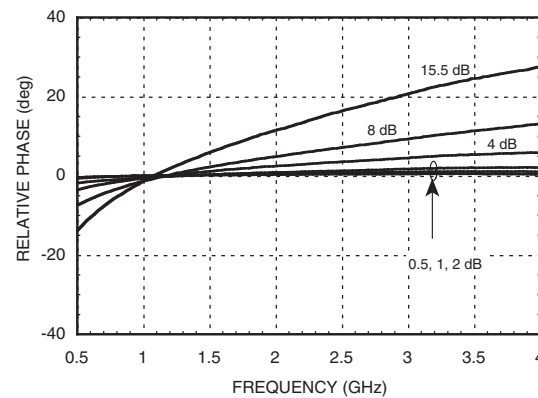

Worst Case Step Error

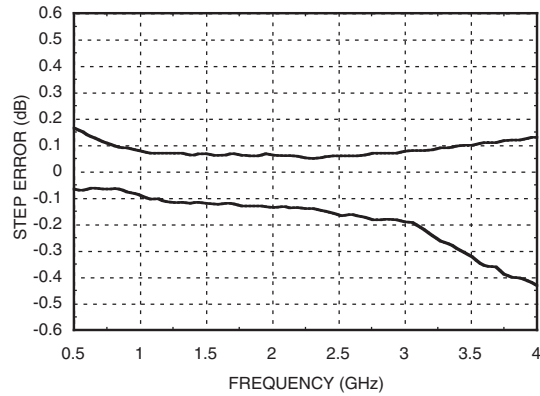

Truth Table

| Control Voltage Input | | | | | Attenuation Setting RF1 - RF2 |
|-----------------------|------------|------------|------------|--------------|----------------------------------|
| V1 8 dB | V2 4 dB | V3 2 dB | V4 1 dB | V5 0.5 dB | |
| High | High | High | High | High | Reference I.L. |
| High | High | High | High | Low | 0.5 dB |
| High | High | High | Low | High | 1 dB |
| High | High | Low | High | High | 2 dB |
| High | Low | High | High | High | 4 dB |
| Low | High | High | High | High | 8 dB |
| Low | Low | Low | Low | Low | 15.5 dB Max. Atten. |

Any combination of the above states will provide an attenuation approximately equal to the sum of the bits selected.

Bias Voltage & Current

| Vdd = +5.0 Vdc ± 10% | |
|----------------------|-----------------|
| Vdd (VDC) | Idd (Typ.) (µA) |
| +3.0 | 4.0 |
| +5.0 | 5.0 |

Control & Bias Voltages

| State | Bias Condition |
|-------|--------------------------|
| Low | 0 to +0.2V @ 1.0 µA Max. |
| High | Vdd ± 0.2V @ 0.5 µA Max. |

Note: Vdd = +3V to +5V ± 0.2V

Application Circuit

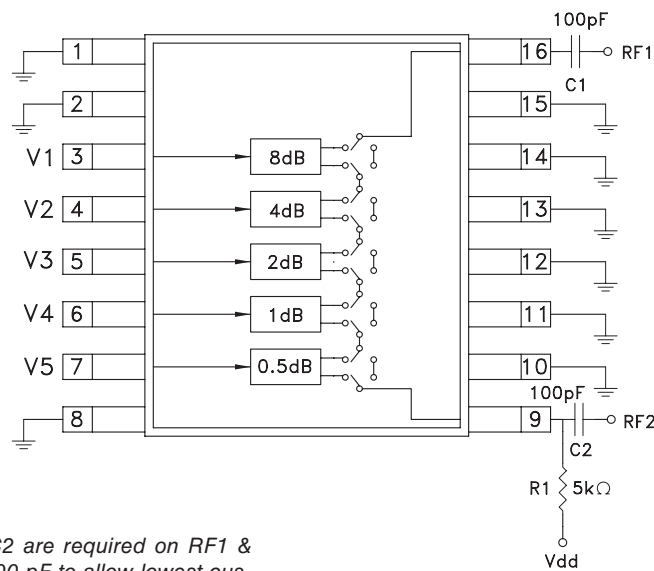

Note:
DC Blocking Capacitors C1 & C2 are required on RF1 & RF2. Choose C1 = C2 = 100 ~ 300 pF to allow lowest customer specific frequency to pass with minimal loss. R1= 5K Ohm is required to supply voltage to the circuit through either Pin 9 or Pin 16.



Absolute Maximum Ratings

| | |
|--------------------------------|----------------|
| RF Input Power (0.7 - 3.8 GHz) | +30 dBm |
| Control Voltage (V1 - V5) | Vdd + 0.5 Vdc |
| Bias Voltage (Vdd) | +8.0 Vdc |
| Channel Temperature | 150 °C |
| Thermal Resistance | 174 °C/W |
| Storage Temperature | -65 to +150 °C |
| Operating Temperature | -40 to +85 °C |
| ESD Sensitivity (HBM) | Class 1A |



ELECTROSTATIC SENSITIVE DEVICE
OBSERVE HANDLING PRECAUTIONS

9

Outline Drawing

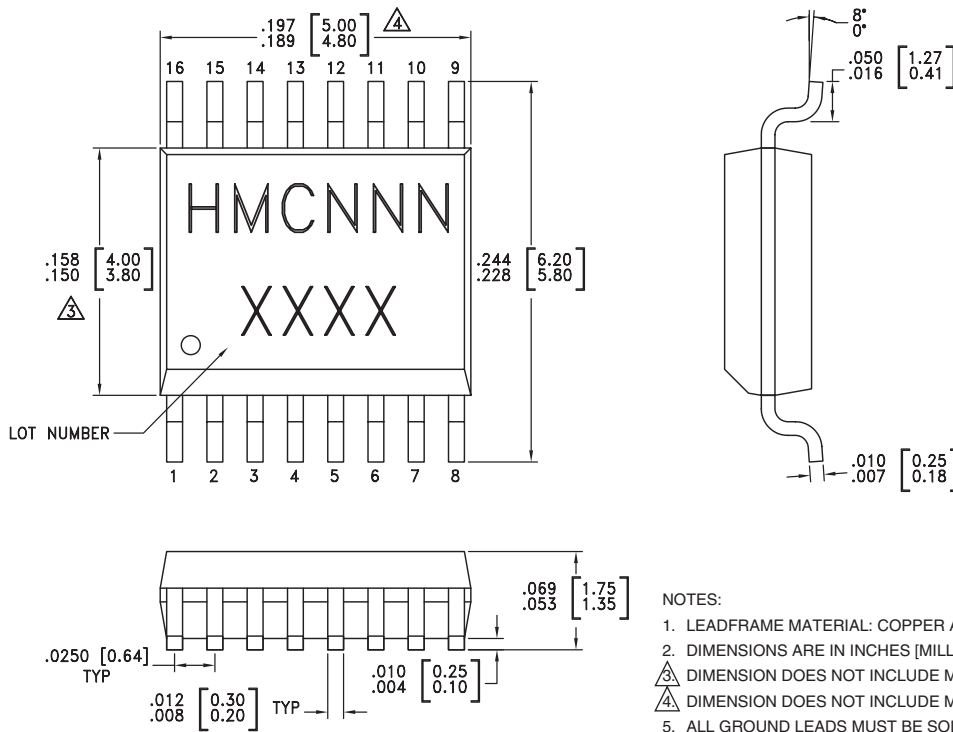

Package Information

| Part Number | Package Body Material | Lead Finish | MSL Rating | Package Marking ^[3] |
|-------------|--|---------------|---------------------|--------------------------------|
| HMC603MS10 | Low Stress Injection Molded Plastic | Sn/Pb Solder | MSL1 ^[1] | HMC603 XXXX |
| HMC603MS10E | RoHS-compliant Low Stress Injection Molded Plastic | 100% matte Sn | MSL1 ^[2] | HMC603 XXXX |

[1] Max peak reflow temperature of 235 °C

[2] Max peak reflow temperature of 260 °C

[3] 4-Digit lot number XXXX



**0.5 dB LSB GaAs MMIC 5-BIT DIGITAL
POSITIVE CONTROL ATTENUATOR, 0.7 - 3.8 GHz**

Pin Descriptions

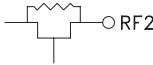
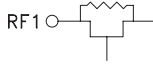
| Pin Number | Function | Description | Interface Schematic |
|------------------|----------|--|---|
| 1, 2, 8, 10 - 15 | GND | These pins must be DC grounded. |  |
| 3 - 7 | V1 - V5 | See truth table and control voltage table. | |
| 9 | RF2 | This pin is DC coupled and matched to 50 Ohm. A blocking capacitor is required. |  |
| 16 | RF1 | This pin is DC coupled and matched to 50 Ohm. A blocking capacitor is required. |  |

Evaluation Circuit Board

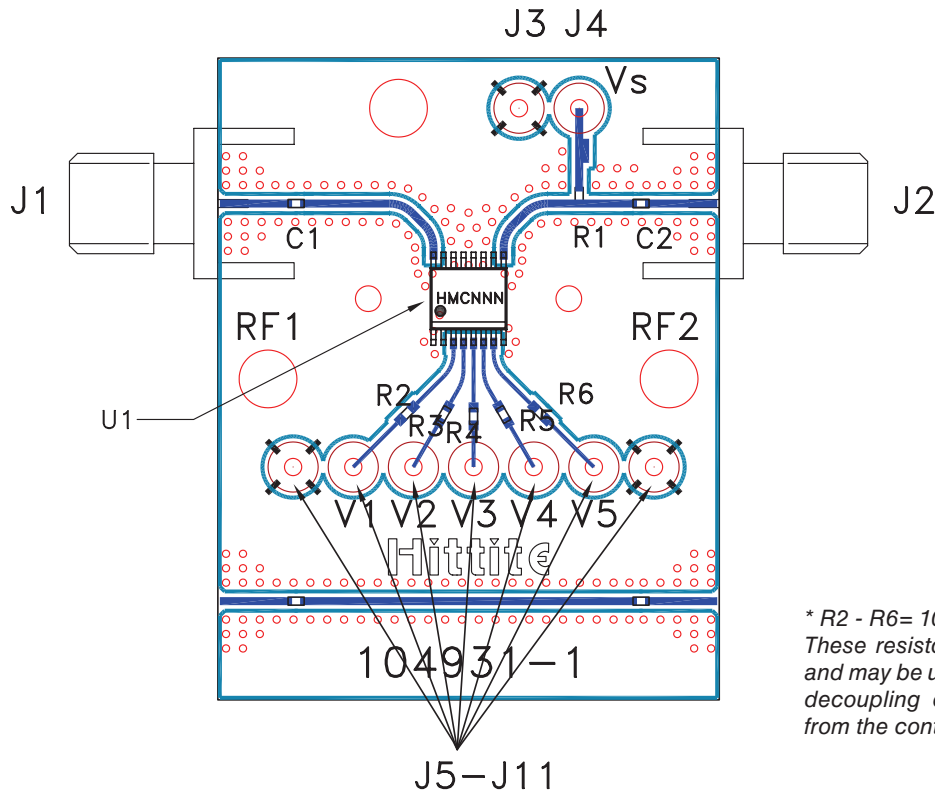

* R2 - R6= 100 Ohm.
These resistors are optional
and may be used to enhance
decoupling of the RF path
from the control inputs.

List of Materials for Evaluation PCB 104976 [1]

| Item | Description |
|----------|--|
| J1 - J2 | PCB Mount SMA Connector |
| J3 - J11 | DC Pin |
| R1 | 5k Ohm Resistor, 0402 Pkg. |
| R2 - R6 | 100 Ohm Resistor, 0402 Pkg. |
| C1 - C2 | 0402 Chip Capacitor, Select Value for Lowest Frequency |
| U1 | HMC603QS16 / HMC603QS16E Digital Attenuators |
| PCB [2] | 104931 Evaluation PCB |

[1] Reference this number when ordering complete evaluation PCB

[2] Circuit Board Material: Rogers 4350

The circuit board used in the final application should use RF circuit design techniques. Signal lines should have 50 ohm impedance while the package ground leads should be connected directly to the ground plane similar to that shown. A sufficient number of via holes should be used to connect the top and bottom ground planes. The evaluation circuit board shown is available from Hittite upon request.