

SMT GaAs HBT MMIC x4 ACTIVE FREQUENCY MULTIPLIER, 9.8 - 11.2 GHz OUTPUT

Typical Applications

Active Multiplier for X Band Applications:

- Fiber Optic
- Pt to Pt Radios
- Military Radar

Features

- Output Power: +4 dBm
- Sub-Harmonic Suppression: >25 dBc
- SSB Phase Noise: -142 dBc/Hz
- Single Supply: 5V@ 52 mA
- 16 mm² Leadless SMT Package

Functional Diagram

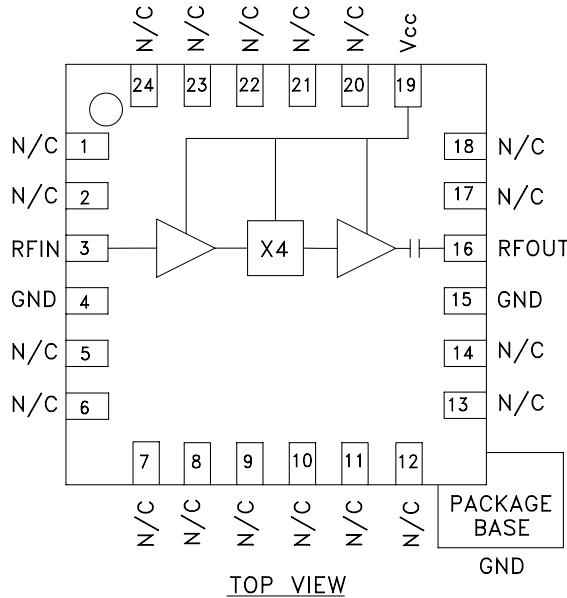

General Description

The HMC443LP4 is an active miniature x4 frequency multiplier utilizing InGaP GaAs HBT technology in a 4 mm x 4 mm leadless surface mount package. Power output is +4 dBm typical from a 5.0V supply voltage and varies little vs. input power, temperature and supply voltage. Suppression of undesired fundamental and sub-harmonics is >25 dBc typical with respect to output signal level. The low additive SSB phase noise of -142 dBc/Hz at 100 kHz offset helps the user maintain good system noise performance. The HMC443LP4 is ideal for use in LO multiplier chains allowing reduced parts count vs. traditional approaches.

Electrical Specifications, $T_A = +25^\circ C, V_{CC} = 5.0V$

Parameter	Min.	Typ.	Max.	Units
Frequency Range, Input	2.45 - 2.80			GHz
Frequency Range, Output	9.8 - 11.2			GHz
Input Power Range	-15		+5	dBm
Output Power	1	4		dBm
Sub-Harmonic Suppression		25		dBc
Input Return Loss		15		dB
Output Return Loss		8		dB
SSB Phase Noise (100 kHz Offset)	Pin= 0 dBm		-142	dBc/Hz
Supply Current (Icc)		52		mA

SMT GaAs HBT MMIC x4 ACTIVE FREQUENCY MULTIPLIER, 9.8 - 11.2 GHz OUTPUT

**Output Power vs.
Temperature @ -10 dBm Drive Level**

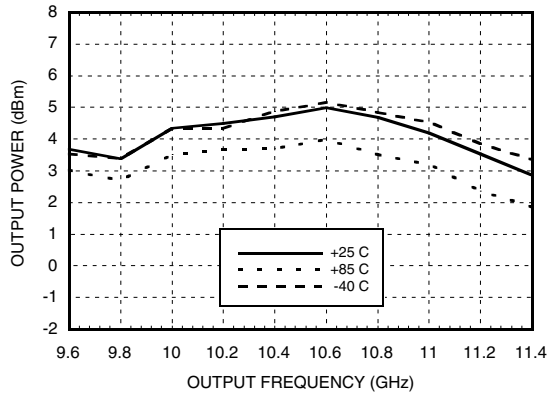

Output Power vs. Drive Level

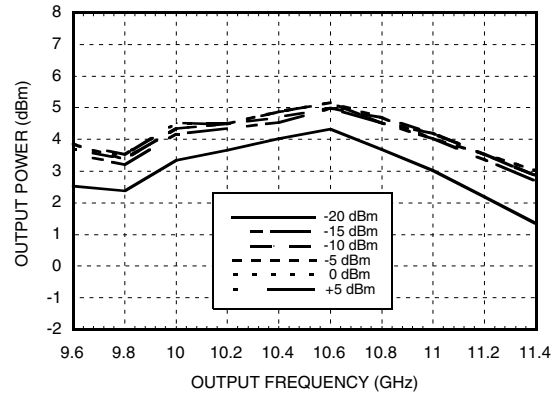

**Output Power vs.
Supply Voltage @ -10 dBm Drive Level**

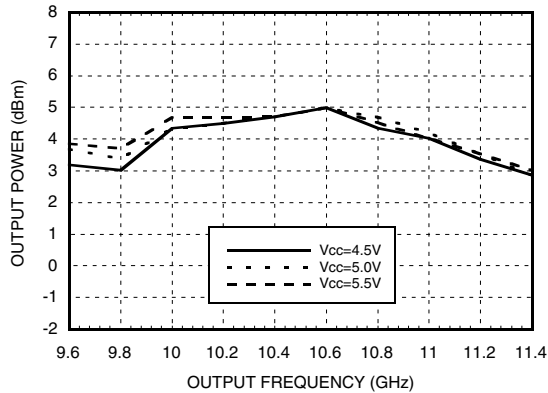

Input Return Loss vs. Temperature

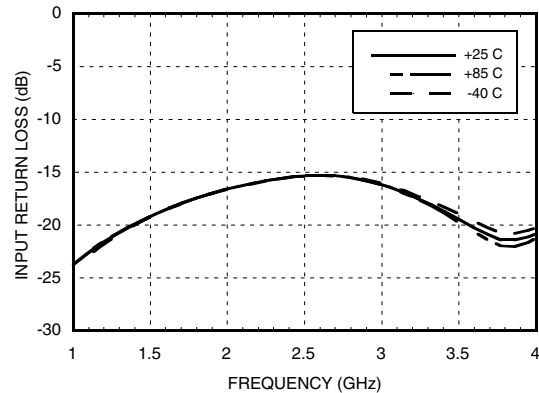

Output Return Loss vs. Temperature

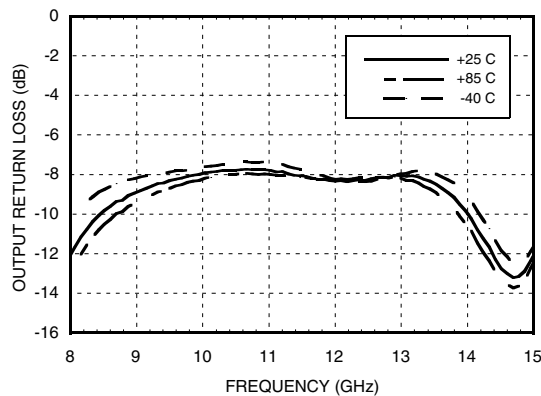

**SMT GaAs HBT MMIC x4 ACTIVE
FREQUENCY MULTIPLIER, 9.8 - 11.2 GHz OUTPUT**

Output Spectrum

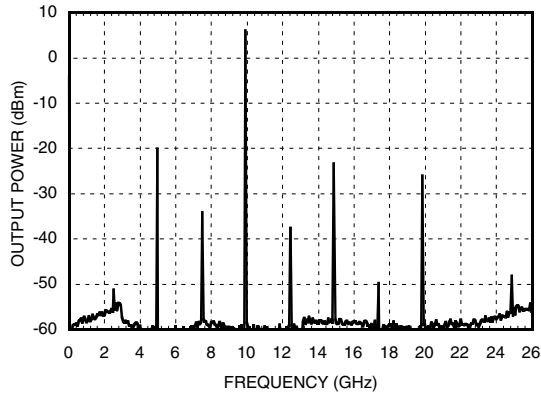

**SSB Phase Noise
Performance, $F_{out} = 10.5$ GHz**

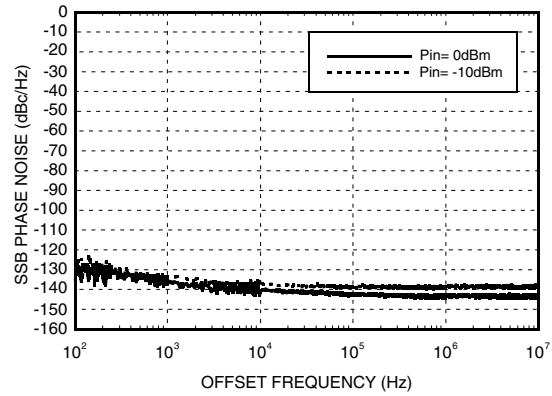

11

FREQ. MULTIPLIERS - SMT

SMT GaAs HBT MMIC x4 ACTIVE FREQUENCY MULTIPLIER, 9.8 - 11.2 GHz OUTPUT

Absolute Maximum Ratings

RF Input (Vcc= +5V)	+20 dBm
Vcc	+6.0V
Storage Temperature	-65 to +150 °C
Operating Temperature	-40 to +85 °C

Typical Supply Current vs. Vcc

Vcc (V)	Icc (mA)
4.5	51
5.0	52
5.5	54

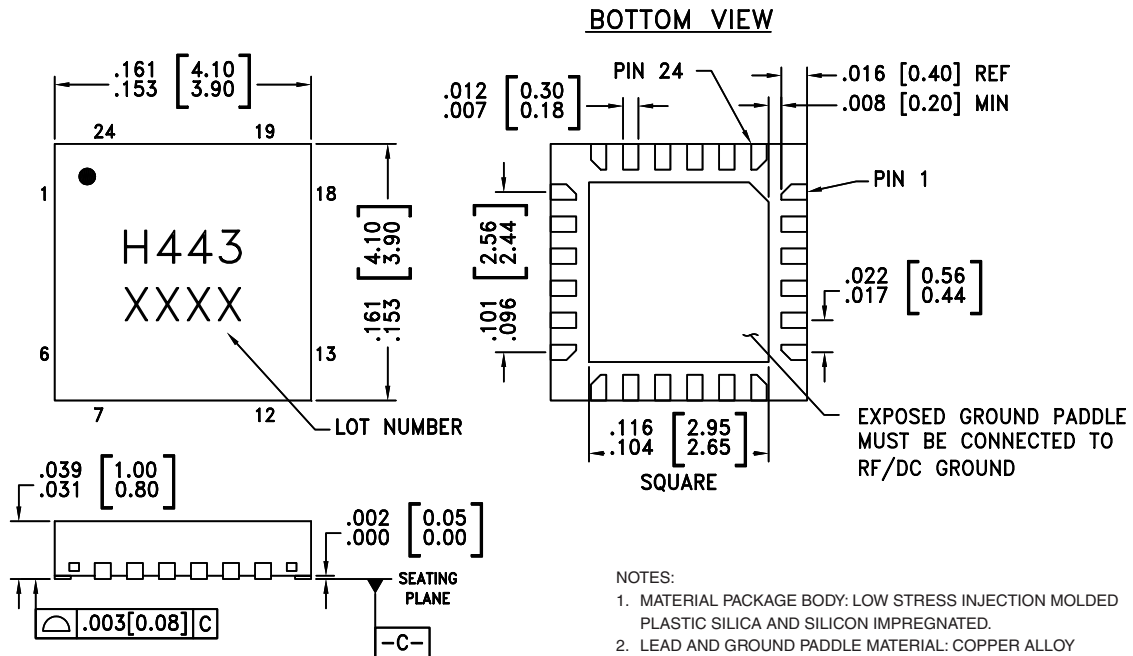

Note: Multiplier will operate over full voltage range shown above.

Pin Locations & Outline Drawing

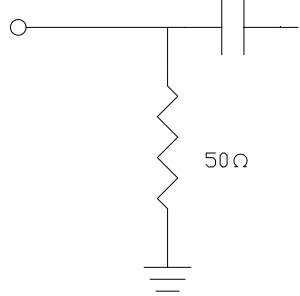

SMT GaAs HBT MMIC x4 ACTIVE FREQUENCY MULTIPLIER, 9.8 - 11.2 GHz OUTPUT

Pin Description

Pin Number	Function	Description	Interface Schematic
1, 2, 5-14, 17, 18, 20-24	N/C	No Connection	
3	RF IN	RF input needs to be DC blocked only if there is an external DC voltage applied to RF IN.	
4, 15	GND	All ground leads and ground paddle must be soldered to PCB RF/DC ground.	
16	RF OUT	Multiplied Output. AC coupled. No external DC blocks necessary.	
19	Vcc	Supply voltage 5V ± 0.5V.	

SMT GaAs HBT MMIC x4 ACTIVE FREQUENCY MULTIPLIER, 9.8 - 11.2 GHz OUTPUT

Evaluation PCB

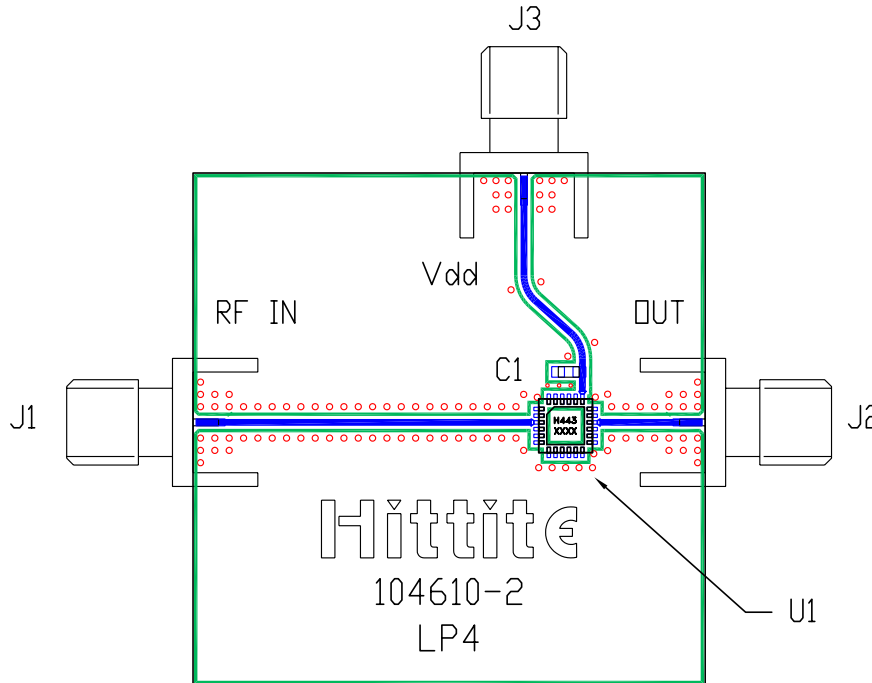

The circuit board used in the final application should be generated with proper RF circuit design techniques. Signal lines should have 50 ohm impedance while the package ground leads and exposed paddle should be connected directly to the ground plane similar to that shown. The evaluation circuit board shown is available from Hittite upon request.

List of Materials

Item	Description
J1 - J3	PC Mount SMA Connector
C1	1,000 pF Capacitor, 0603 Pkg.
U1	HMC443LP4, x4 Active Multiplier
PCB*	104610 Eval Board
* Circuit Board Material: Rogers 4350	