

## SMT GaAs HBT MMIC DIVIDE-BY-2, DC - 8.0 GHz

### Typical Applications

Prescaler for DC to C Band PLL Applications:

- UNII, Pt. - Pt. & VSAT Radios
- 802.11a & HiperLAN WLAN
- Fiber Optic
- Cellular / 3G Infrastructure

### Features

- Ultra Low SSB Phase Noise: -148 dBc/Hz
- Single-Ended I/O's
- Output Power: -3 to -9 dBm
- Single DC Supply: +3V @ 42 mA
- 9 mm<sup>2</sup> Ultra Small Package: SOT26

### Functional Diagram

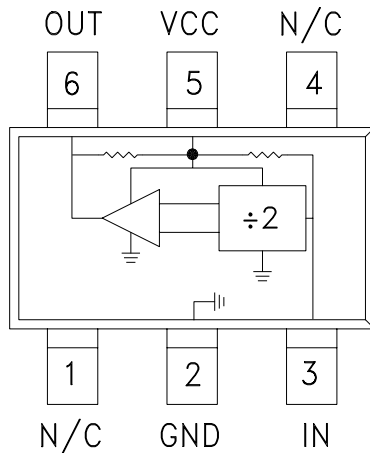

### General Description

The HMC432 is a low noise Divide-by-2 Static Divider utilizing InGaP GaAs HBT technology in an ultra small surface mount SOT26 plastic package. This device operates from DC (with a square wave input) to 8.0 GHz input frequency with a single +3.0V DC supply. Single-ended inputs and outputs reduce component count and cost. The low additive SSB phase noise of -148 dBc/Hz at 100 kHz offset helps the user maintain good system noise performance.

### Electrical Specifications, $T_A = +25^\circ\text{C}$ , 50 Ohm System, $V_{CC} = +3V$

Parameter	Conditions	Min.	Typ.	Max.	Units
Maximum Input Frequency		8	8.5		GHz
Minimum Input Frequency	Sine Wave Input. [1]		0.2		GHz
Input Power Range	Fin= 1 to 7 GHz Fin= 7 to 8 GHz	-12 -4	-15 -8	+12 +10	dBm
Output Power	Fin= 4 GHz Fin= 8 GHz	-6 -12	-3 -9		dBm dBm
Reverse Leakage	RF Output Terminated, Fin= 4 GHz, Pin= 0 dBm		-30		dBm
SSB Phase Noise (100 kHz offset)	Pin= 0 dBm, Fin= 4 GHz		-148		dBc/Hz
Output Transition Time	Pin= 0 dBm, Fout= 882 MHz		145		ps
Supply Current (Icc)	Vcc= 3.0 V		42		mA

1. Divider will operate down to DC for square-wave input signal.

## SMT GaAs HBT MMIC DIVIDE-BY-2, DC - 8.0 GHz

**Input Sensitivity Window,  $T = 25\text{ }^{\circ}\text{C}$**

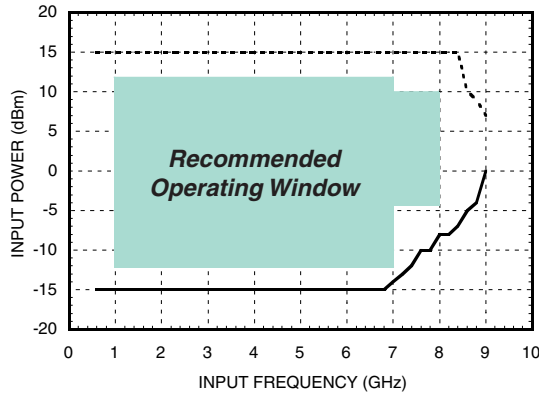

**Input Sensitivity Window vs. Temperature**

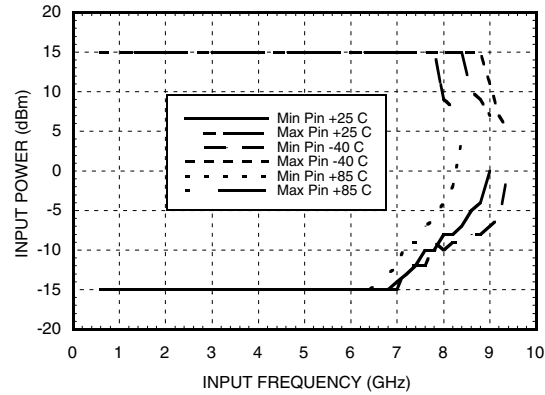

**Output Power vs. Temperature**

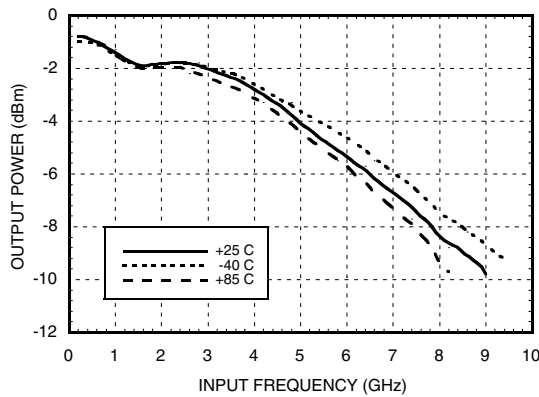

**SSB Phase Noise Performance,  $P_{in} = 0\text{ dBm}$ ,  $T = 25\text{ }^{\circ}\text{C}$**

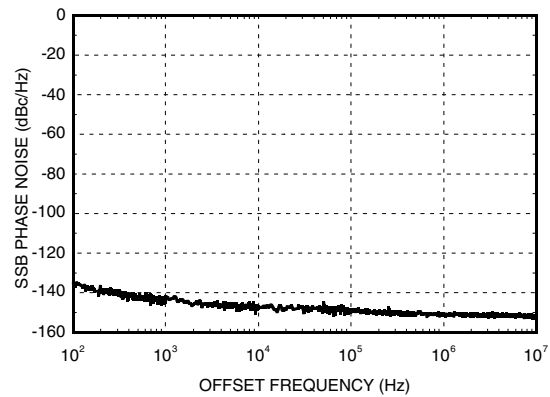

**Output Harmonic Content,  $P_{in} = 0\text{ dBm}$ ,  $T = 25\text{ }^{\circ}\text{C}$**

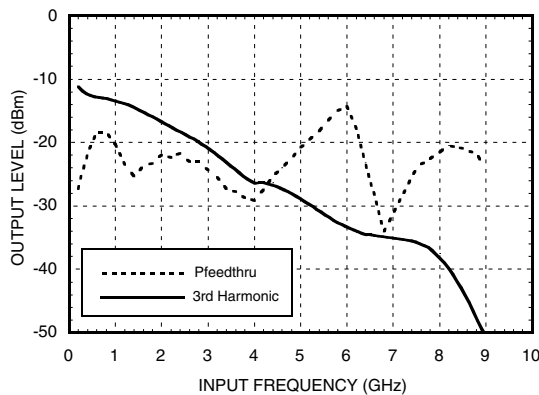

**Reverse Leakage,  $P_{in} = 0\text{ dBm}$ ,  $T = 25\text{ }^{\circ}\text{C}$**

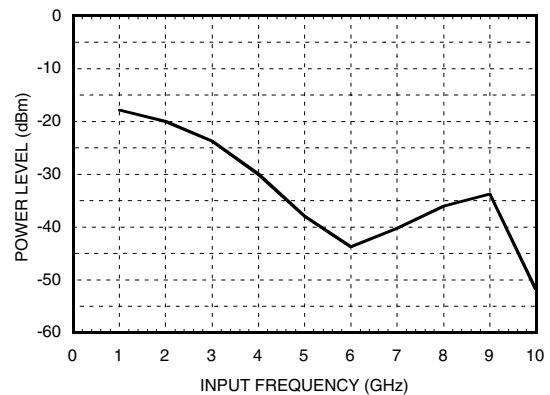

## SMT GaAs HBT MMIC DIVIDE-BY-2, DC - 8.0 GHz

**Output Voltage Waveform,**  
Pin= 0 dBm, Fout= 882 MHz, T= 25 °C

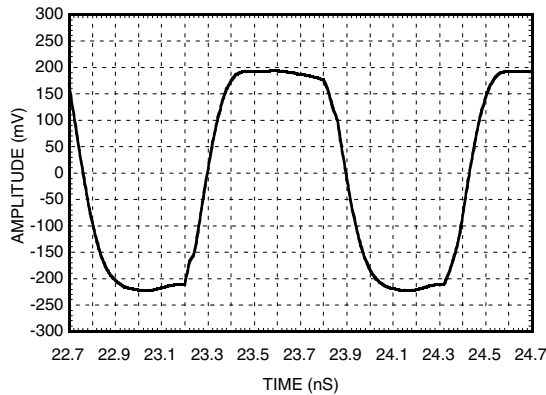

### Absolute Maximum Ratings

RF Input (Vcc= +3.0V)	+15 dBm
Vcc	+3.5V
Maximum Channel Temperature	135 °C
Continuous Pdiss (T=85 °C) (derate 4.44mW/°C above 85 °C)	222 mW
Storage Temperature	-65 to +150 °C
Operating Temperature	-40 to +85 °C

DC blocking capacitors are required at RF input and RF output ports.  
Choose value for lowest frequency of operation.

### Typical Supply Current vs. Vcc

Vcc (V)	Icc (mA)
2.70	34
3.0	42
3.30	50

Note: Divider will operate over full voltage range shown above

### Outline Drawing

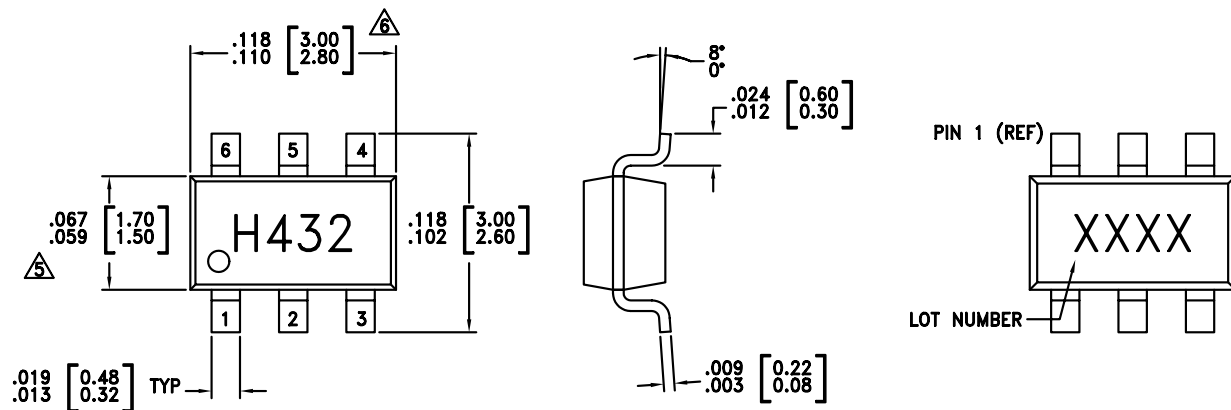

NOTES:

- PACKAGE BODY MATERIAL: LOW STRESS INJECTION MOLDED PLASTIC SILICA AND SILICON IMPREGNATED.
- LEADFRAME MATERIAL: COPPER ALLOY
- LEADFRAME PLATING: Sn/Pb SOLDER
- DIMENSIONS ARE IN INCHES [MILLIMETERS].
- $\Delta$  DIMENSION DOES NOT INCLUDE MOLDFLASH OF 0.15mm PER SIDE.
- $\Delta$  DIMENSION DOES NOT INCLUDE MOLDFLASH OF 0.25mm PER SIDE.
- ALL GROUND LEADS MUST BE SOLDERED TO PCB RF GROUND.

## SMT GaAs HBT MMIC DIVIDE-BY-2, DC - 8.0 GHz

### Pin Description

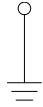
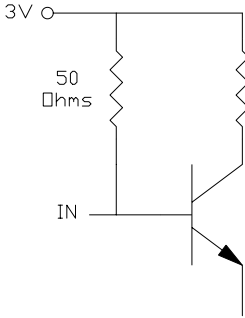
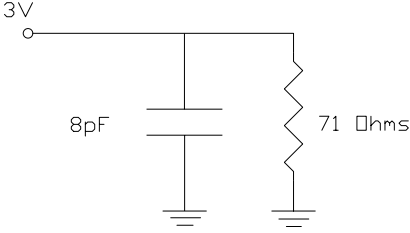
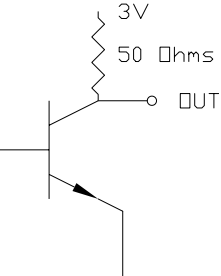
Pin Number	Function	Description	Interface Schematic
1, 4	N/C	No Connection	
2	GND	Pin must connect to RF/DC ground.	
3	IN	RF input must be DC blocked.	
5	Vcc	Supply voltage 3V ± 0.3V.	
6	OUT	Divided output must be DC blocked.	

## SMT GaAs HBT MMIC DIVIDE-BY-2, DC - 8.0 GHz

### Evaluation PCB

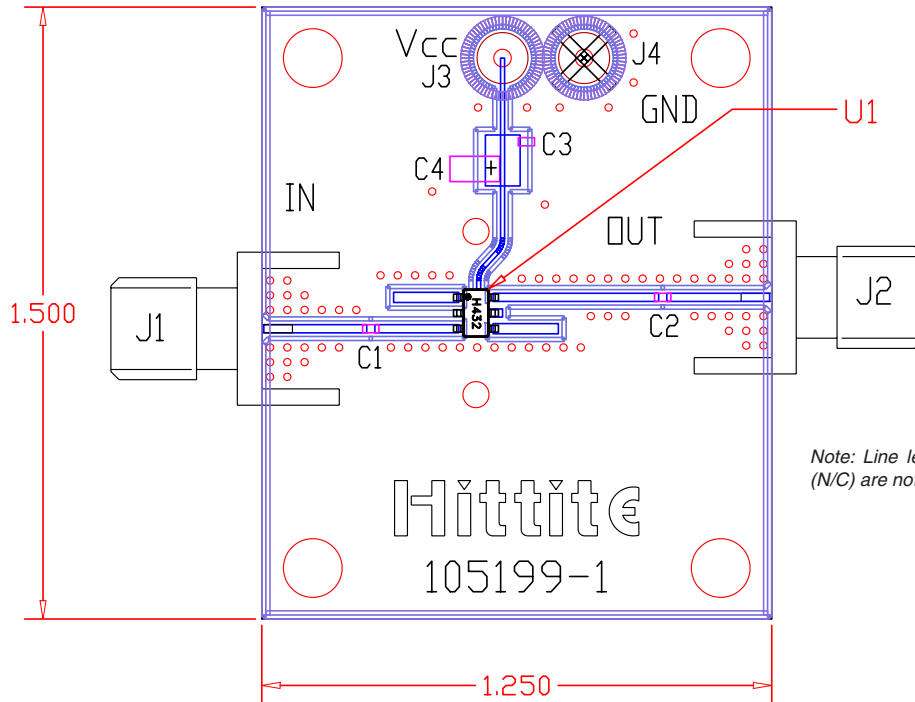

### List of Materials

Item	Description
J1 - J2	PC Mount SMA RF Connector
J3 - J4	DC Pin
C1 - C2	100 pF Capacitor, 0402 Pkg.
C3	1000 pF Capacitor, 0402 Pkg.
C4	10 $\mu$ F Tantalum Capacitor, 1206 Pkg.
U1	HMC432 Divide-by-2
PCB*	105199 Eval Board
* Circuit Board Material: Rogers 4350	

The circuit board used in the final application should use RF circuit design techniques. Signal lines should have 50 ohm impedance while the package ground leads should be connected directly to the ground plane similar to that shown. A sufficient number of via holes should be used to connect the top and bottom ground planes. The evaluation circuit board shown is available from Hittite upon request.

## SMT GaAs HBT MMIC DIVIDE-BY-2, DC - 8.0 GHz

### Application Circuit

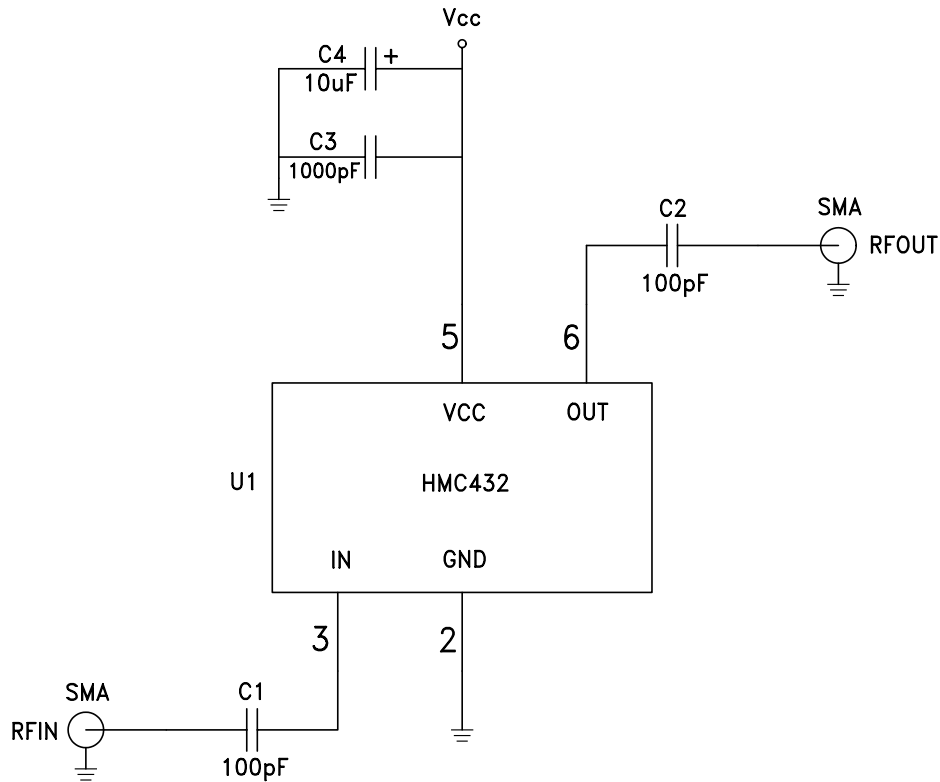

**Note:**

DC blocking capacitor values (C1, C2) and DC decoupling capacitor values (C3, C4) are chosen for lowest frequency of operation.