

GaAs MMIC SMT VOLTAGE-VARIABLE ATTENUATOR DC - 10 GHz

FEBRUARY 2001

v03.0400

Features

WIDE BANDWIDTH: DC - 10 GHz

LOW PHASE SHIFT VS. ATTENUATION

25 dB ATTENUATION RANGE

SIMPLIFIED VOLTAGE CONTROL

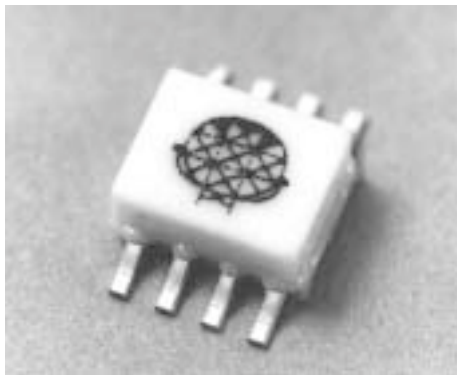

General Description

The HMC121C8 is an absorptive Voltage Variable Attenuator (VVA) in a non-hermetic surface-mount package covering DC - 10 GHz. It features an on-chip reference attenuator for use with an external op-amp to provide simple single voltage attenuation control, 0 to -3V. The device is ideal in designs where an analog DC control signal must control RF signal levels over a 25 dB amplitude range. Applications include AGC circuits and temperature compensation of multiple gain stages in microwave point-to-point and VSAT radios. See HMC121G8 for a hermetic SMT version of this device.

Guaranteed Performance, 50 ohm system, -55 to +85 deg C

Parameter		Min	Typical	Max	Units
Insertion Loss	DC - 6 GHz :		2.0	2.5	dB
	DC - 8 GHz :		2.2	3.2	dB
	DC - 10 GHz :		3.5	4.5	dB
Attenuation Range	DC - 6 GHz:	20	25		dB
	DC - 10 GHz :	25	30		
Return Loss	DC - 8 GHz:	11	15		dB
	DC - 10 GHz :	8	12		dB
Switching Characteristics	tRISE, tFALL (10/90% RF):		3		ns
	tON, tOFF (50% CTL to 10/90% RF):		6		ns
Input Power for 0.25 dB Compression (0.5 - 10 GHz)	Min. Atten:		+3		dBm
	Atten. >2 dB:		-3		dBm
Input Third Order Intercept (two - 8 dBm signals, 0.5 - 10 GHz)	Min. Atten:		+18		dBm
			+10		dBm

HMC121C8 SMT VOLTAGE-VARIABLE ATTENUATOR DC - 10 GHz

v03.0400

FEBRUARY 2001

Insertion Loss

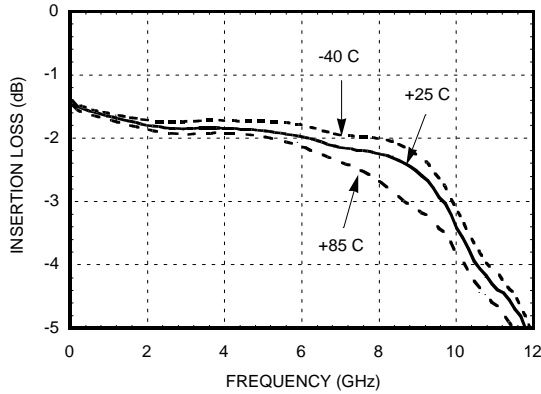

Relative Attenuation

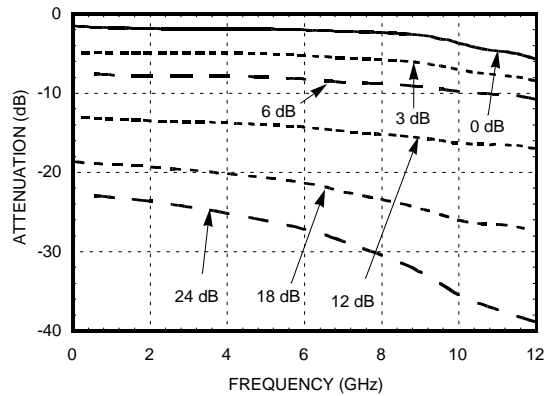

Return Loss

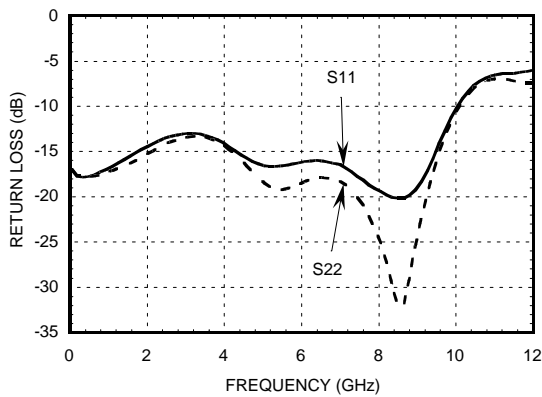

Relative Attenuation vs. Control Voltage @ 4.2 GHz

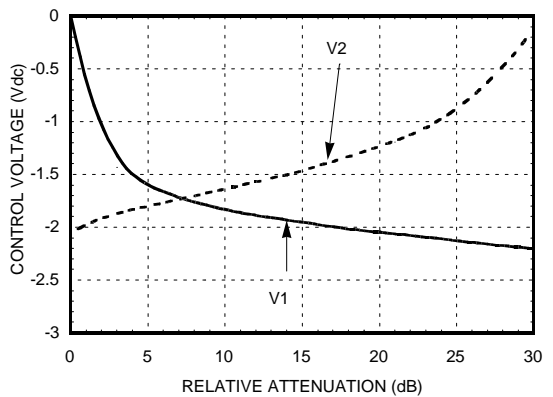

Relative Phase

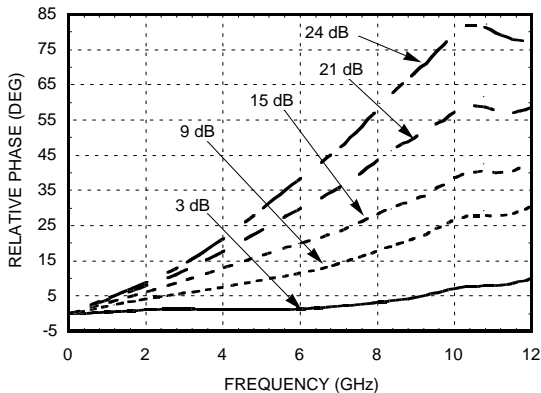

Relative Attenuation vs. Control Voltage @ 10 GHz

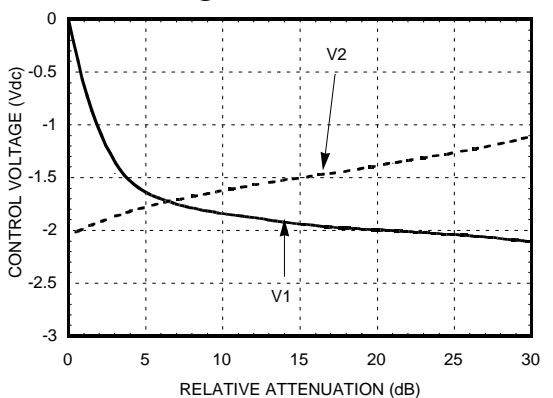

HMC121C8 SMT VOLTAGE-VARIABLE ATTENUATOR DC - 10 GHz

FEBRUARY 2001

v03.0400

2
ATTENUATORS
SMT

Input Third Order Intercept vs. Attenuation

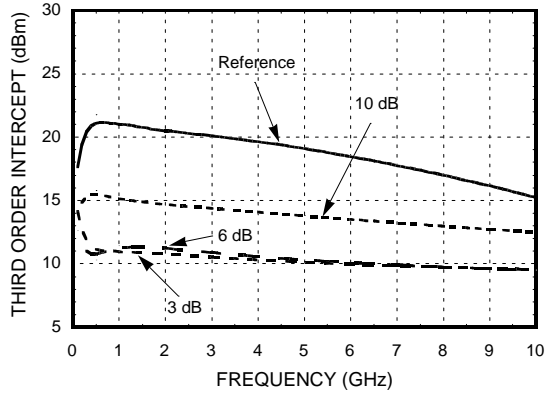

Input Second Order Intercept vs. Attenuation

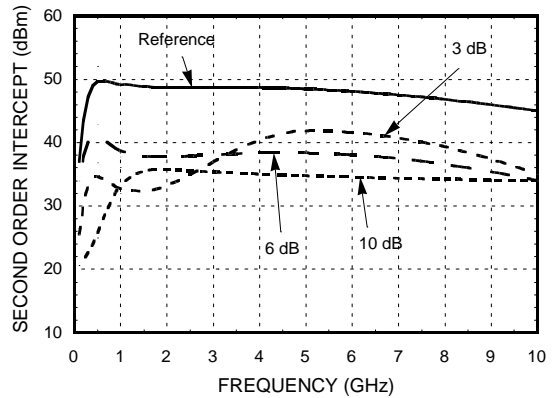

0.25 dB Compression vs. Attenuation

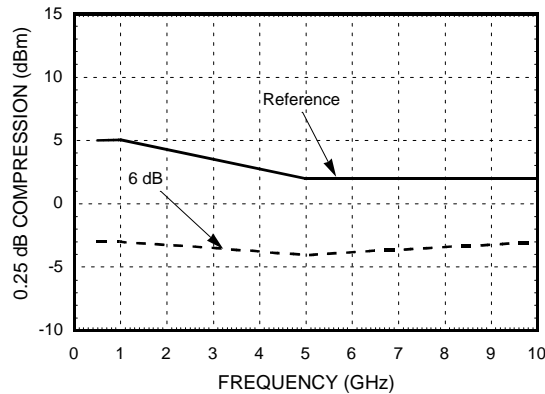

1 dB Compression vs. Attenuation

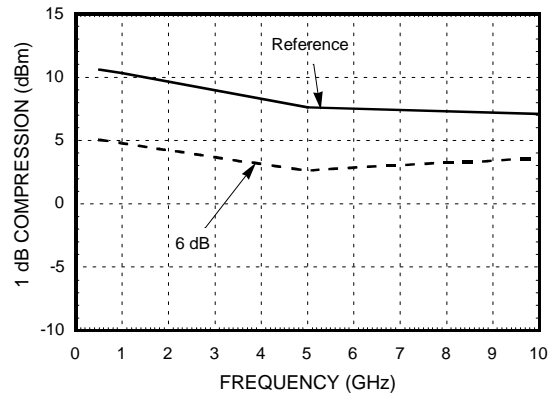

Second Harmonic vs. Attenuation

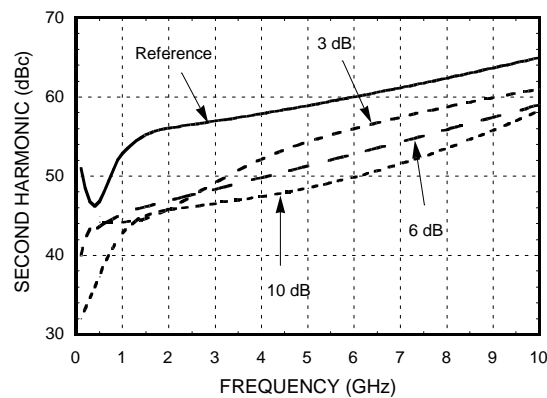

HMC121C8 SMT VOLTAGE-VARIABLE ATTENUATOR DC - 10 GHz

v03.0400

FEBRUARY 2001

Schematic

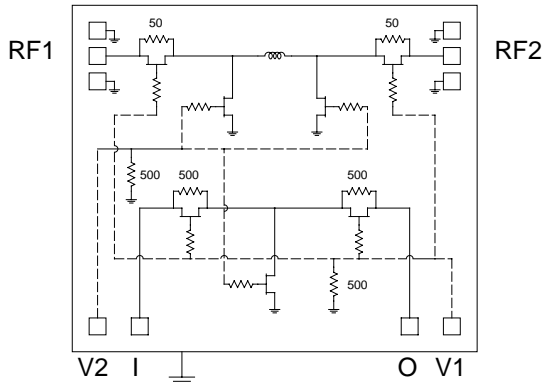

Absolute Maximum Ratings

RF Input	+16dBm
Control Voltage Range	+1.0 to -6.0 Vdc
Storage Temperature	-65 to +150 deg C
Operating Temperature	-55 to +85 deg C

Outline Drawing

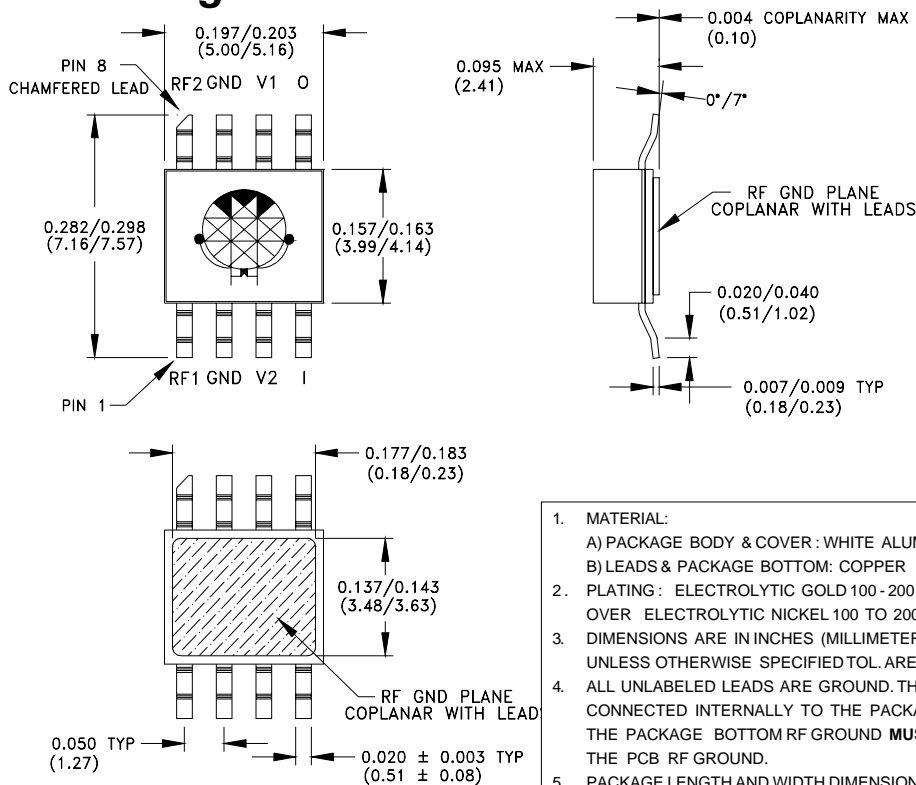

- MATERIAL:
 - PACKAGE BODY & COVER: WHITE ALUMINA (92%)
 - LEADS & PACKAGE BOTTOM: COPPER
- PLATING: ELECTROLYTIC GOLD 100-200 MICROINCHES OVER ELECTROLYTIC NICKEL 100 TO 200 MICROINCHES.
- DIMENSIONS ARE IN INCHES (MILLIMETERS). UNLESS OTHERWISE SPECIFIED TOL. ARE ± 0.005 (± 0.13).
- ALL UNLABELED LEADS ARE GROUND. THESE LEADS ARE CONNECTED INTERNALLY TO THE PACKAGED BOTTOM GROUND. THE PACKAGE BOTTOM RF GROUND **MUST** BE SOLDERED TO THE PCB RF GROUND.
- PACKAGE LENGTH AND WIDTH DIMENSIONS SHOWN DO NOT INCLUDE LID SEAL PROTRUSION. ALLOWABLE PROTRUSION SHALL BE 0.005 (0.127MM) PER SIDE.

HMC121C8 SMT VOLTAGE-VARIABLE ATTENUATOR DC - 10 GHz

FEBRUARY 2001

v02.0400

Single-Line Control Driver

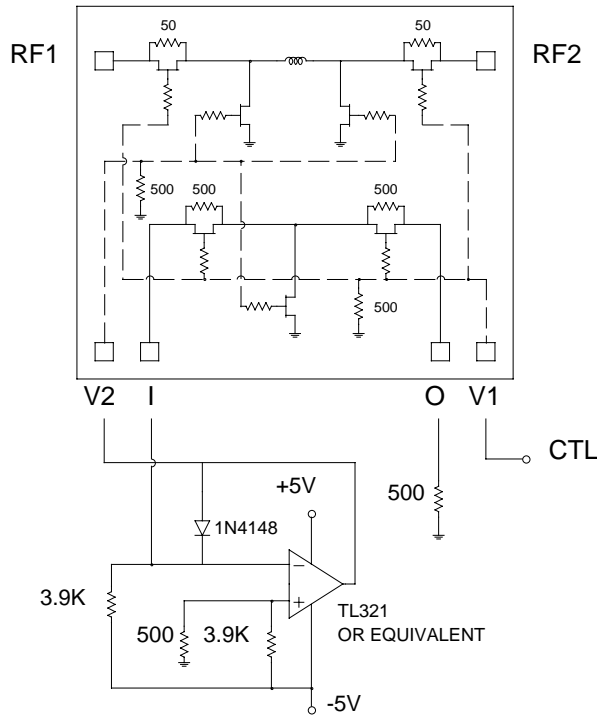

External op-amp control circuit maintains impedance match while attenuation is varied. Input control ranges from 0 Volts (min. attenuation) to -2.5 Volts (max. attenuation.)

2
SMT ATTENUATORS

HMC121C8 SMT VOLTAGE-VARIABLE ATTENUATOR DC - 10 GHz

v02.0400

FEBRUARY 2001

Evaluation PCB

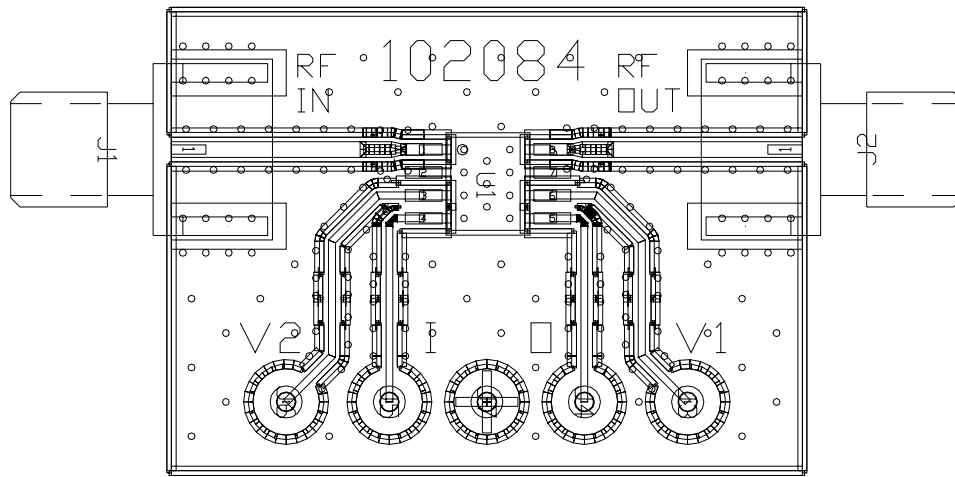

The circuit board used in the final application should be generated with proper RF circuit design techniques. Signal lines at the RF port should have 50 ohm impedance and the package ground leads and package bottom ground should be connected directly to the ground plane similar to that shown above. The evaluation circuit board shown above is available from Hittite Microwave Corporation upon request.

List of Material

Item	Description
J1 - J2	PC Mount SMA RF Connector
J3 - J7	DC PIN
U1	HMC121C8 VVA
PCB*	102084 Eval Board
* Circuit Board Material : Rogers 4350	