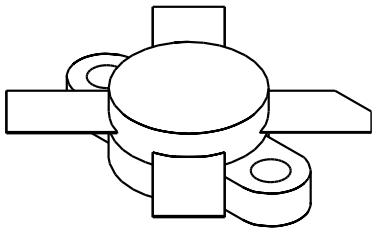

# VAM 80

80 Watts, 27 Volts, Class AB  
Defcom 100 - 150 MHz

<p><b>GENERAL DESCRIPTION</b> The VAM 80 is a COMMON EMITTER, specifically designed for collector modulated operation in the VHF AM applications in the 100-150 MHz range.</p> <p><b>ABSOLUTE MAXIMUM RATINGS</b> Maximum Power Dissipation @ 25°C                      85 Watts</p> <p><b>Maximum Voltage and Current</b> BVces    Collector to Emitter Voltage                      60 Volts BVebo    Emitter to Base Voltage                                    4.0 Volts Ic         Collector Current    8.5 A</p> <p><b>Maximum Temperatures</b> Storage Temperature    - 65 to +150°C Operating Junction Temperature                                +200°C</p>	<p><b>CASE OUTLINE</b> <b>55HT, Style 2</b></p> 
--	---

## ELECTRICAL CHARACTERISTICS @ 25 °C

SYMBOL	CHARACTERISTICS	TEST CONDITIONS	MIN	TYP	MAX	UNITS
<b>Pout</b>	Power Output	F = 150 MHz	80			Watts
<b>Pin</b>	Power Input	Vcc = 27V, 1 KHz, 50%		8	10	Watts
<b>Pg</b>	Power Gain		9.0	10		dB
<b>Pout</b>		F = 150 MHz	20			Watts
<b>Pin</b>		Vcc = 13.5 Volts		4.0	5.0	Watts
<b>Pg</b>			6.0	7.0		dB
<b>ηc</b>	Efficiency			65		%
<b>VSWR</b>	Load Mismatch Tolerance	Vcc = 13.5V, Po=20W			30:1	

<b>BVebo</b>	Emitter to Base Breakdown	Ie = 5 mA	4.0			Volts
<b>BVces</b>	Collector to Emitter Breakdown	Ic = 20 mA	60			Volts
<b>BVceo</b>	Collector to Emitter Breakdown	Ie = 50 mA	32			Volts
<b>Cob</b>	Output Capacitance	Vcb = 28 V, F = 1 MHz			75	pF
<b>hFE</b>	DC - Current Gain	Vce = 5 V, Ic = 1 mA	10			
<b>θjc</b>	Thermal Resistance				2.0	°C/W

Issue August 1996

GHz TECHNOLOGY INC. RESERVES THE RIGHT TO MAKE CHANGES WITHOUT FURTHER NOTICE. GHz RECOMMENDS THAT BEFORE THE PRODUCT(S) DESCRIBED HEREIN ARE WRITTEN INTO SPECIFICATIONS, OR USED IN CRITICAL APPLICATIONS, THAT THE PERFORMANCE CHARACTERISTICS BE VERIFIED BY CONTACTING THE FACTORY.

**DC SAFE OPERATING AREA**

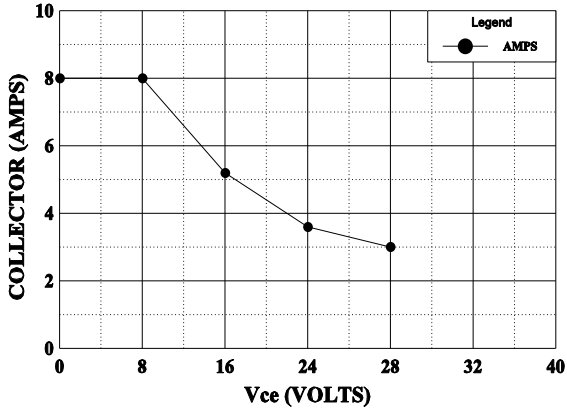

**POWER OUTPUT vs POWER INPUT**

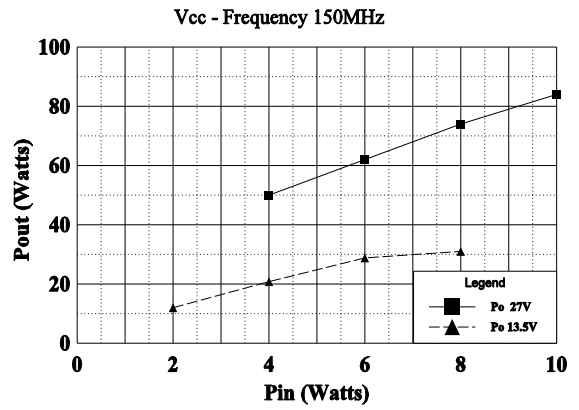

**POWER GAIN vs FREQUENCY**

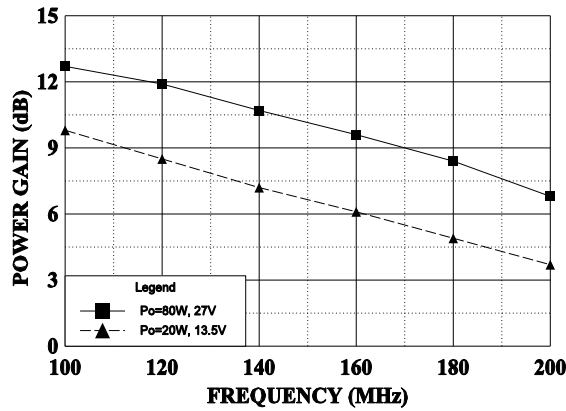

**SERIES INPUT IMPEDANCE vs FREQUENCY**

Vcc = 27V, Po=80W

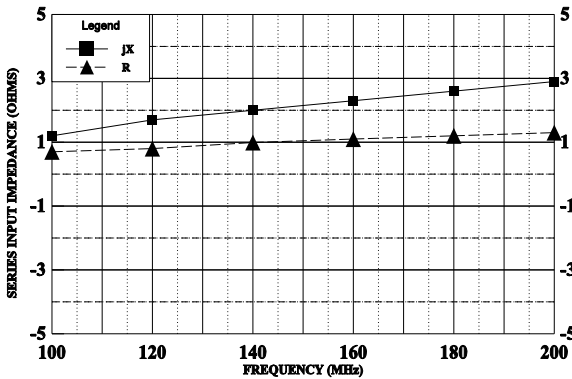

**SERIES LOAD IMPEDANCE vs FREQUENCY**

Po=80W Vcc=27V

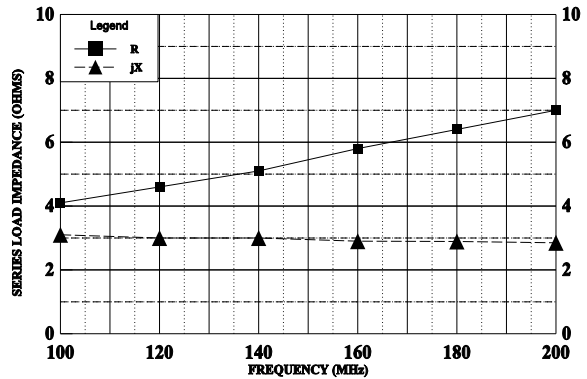

## 150 MHz TEST AMPLIFIER

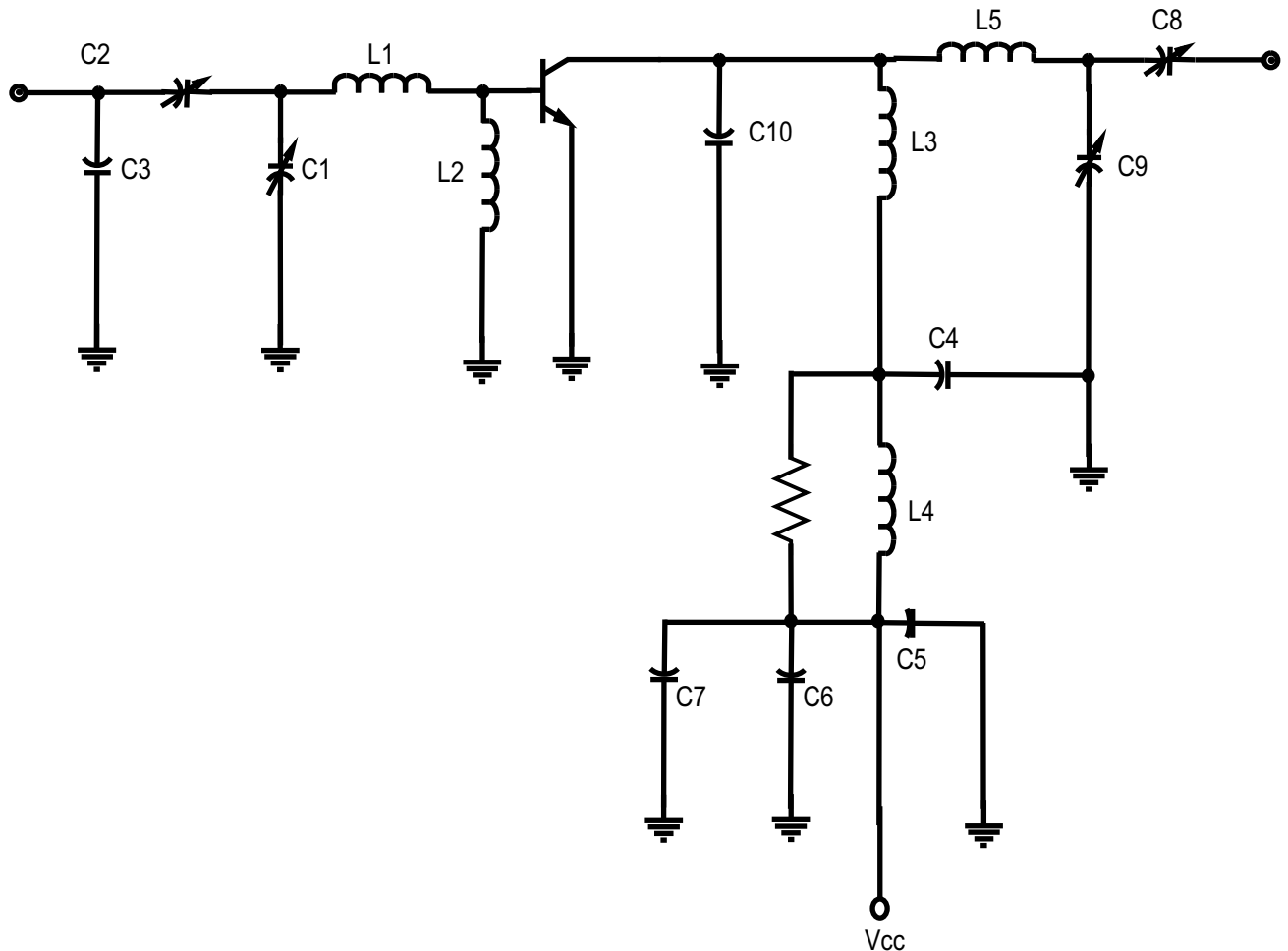

- C1, C2, C8, C9 ..... 4.40pF - compression Mica
- C3 ..... 10pF - uncased mica
- C4 ..... 250pF - uncased mica
- C5 ..... .01mf ceramic
- C6 ..... 1mf ceramic
- C7 ..... 1/0mf electrolytic
- C10 ..... 22pF - uncased mica
- L1 ..... 1/2" x 5/8" x .01" copper strap
- L2 ..... .68mh RFC
- L3 ..... 4 turns #16 3/16" I.D. -1/2" long
- L4 ..... 10mh RFC
- L5 ..... 1 1/2" x 3/16" x .01" copper strap