

## ショットキーバリアダイオード

### SCHOTTKY BARRIER DIODE

## ■外形寸法：Outline Drawings

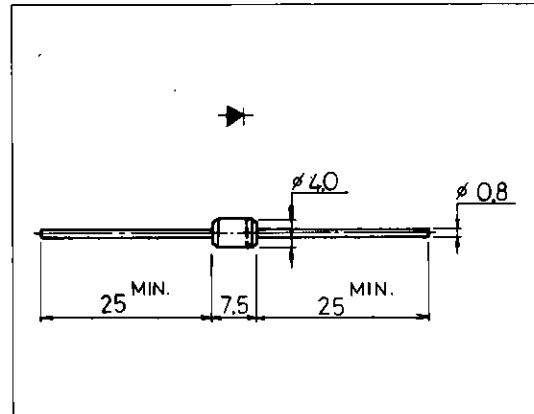

## ■特長：Features

- 低 $V_F$   
Low  $V_F$
- スイッチングスピードが非常に速い  
Super high speed switching.
- プレーナー技術による高信頼性  
High reliability by planer design.

## ■用途：Applications

- 高速電力スイッチング  
High speed power switching.

## ■表示：Marking

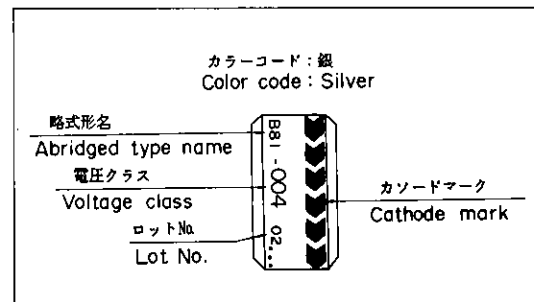

## ■定格と特性：Maximum Ratings and Characteristics

### ●絶対最大定格：Absolute Maximum Ratings

Items	Symbols	Conditions	Ratings	Units
ピーク繰り返し逆電圧 Repetitive Peak Reverse Voltage	$V_{RRM}$		40	V
平均順電流 Average Forward Current	$I_{F(AV)}$	$T_a = 25^\circ\text{C}$	1.7	A
サージ電流 Surge Current	$I_{FSM}$	正弦波 10ms Sine wave	100	A
接合温度 Operating Junction Temperature	$T_j$		-40 ~ +125	$^\circ\text{C}$
保存温度 Storage Temperature	$T_{stg}$		-40 ~ +125	$^\circ\text{C}$

### ●電気的特性(特に指定がない限り周囲温度 $T_a = 25^\circ\text{C}$ とする)

Electrical Characteristics ( $T_a = 25^\circ\text{C}$  Unless otherwise specified)

Items	Symbols	Conditions	Max.	Units
順電圧 Forward Voltage Drop	$V_{FM}$	$I_{FM} = 2.0\text{A}$	0.55	V
逆電流 Reverse Current	$I_{RRM}$	$V_R = V_{RRM}$	5.0	mA

■特性曲線 : Characteristics

A

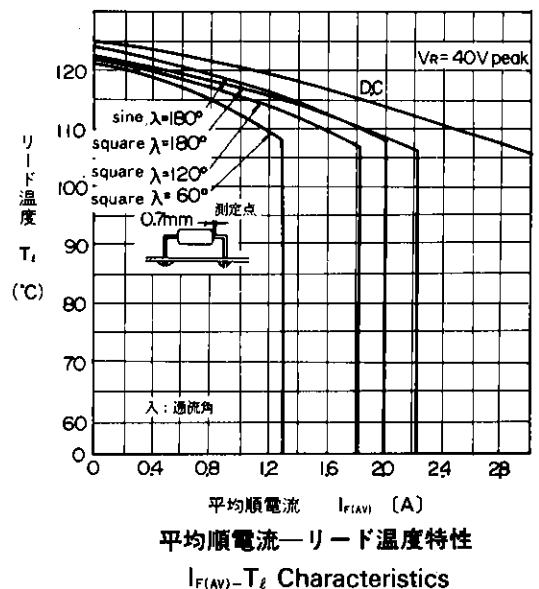
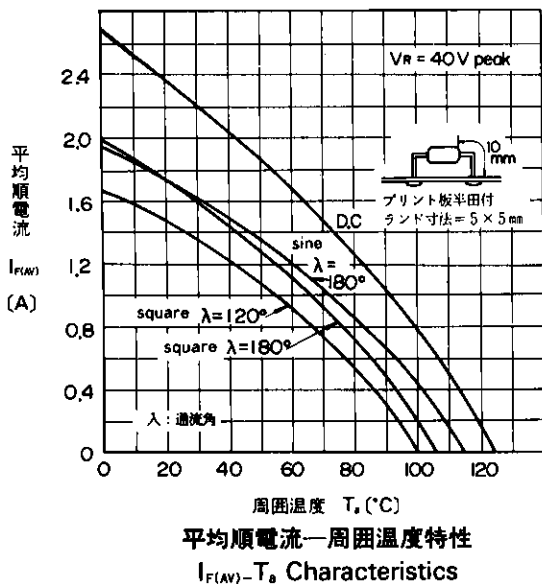
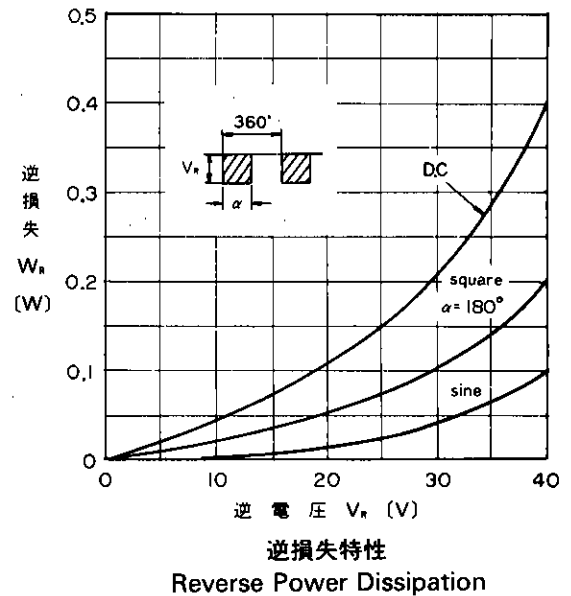
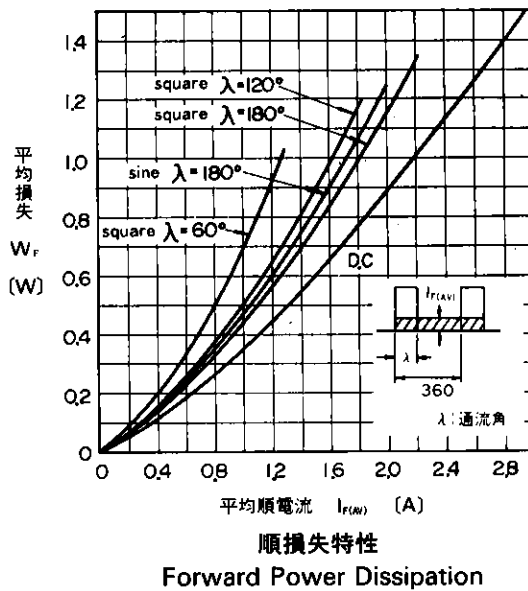
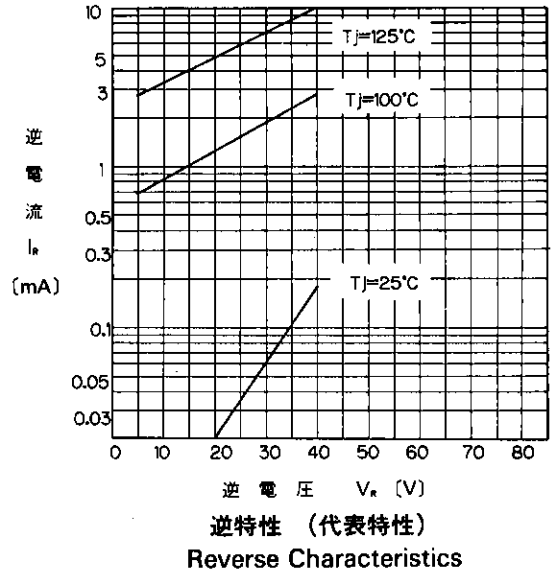
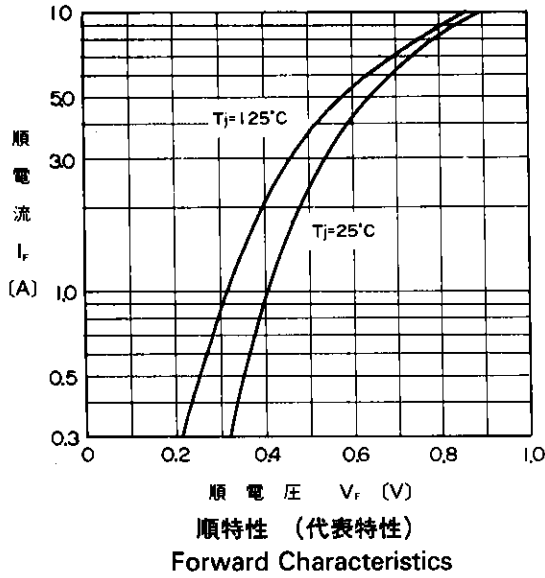

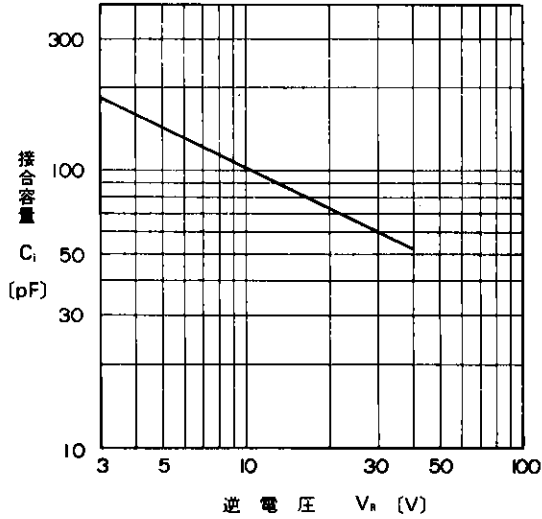

接合容量特性 (代表特性)  
Junction Capacitance Characteristics

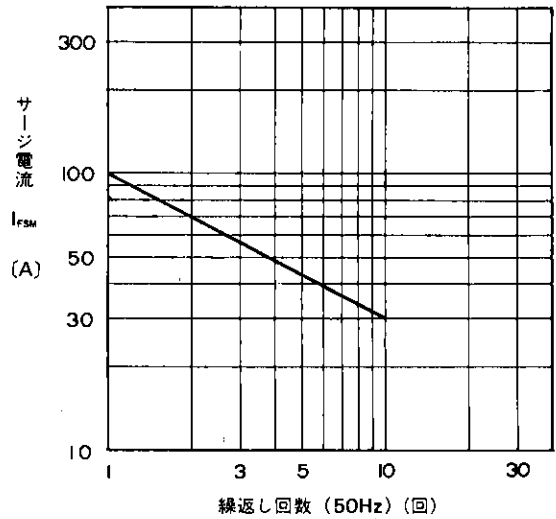

サージ電流耐量  
Surge Capability

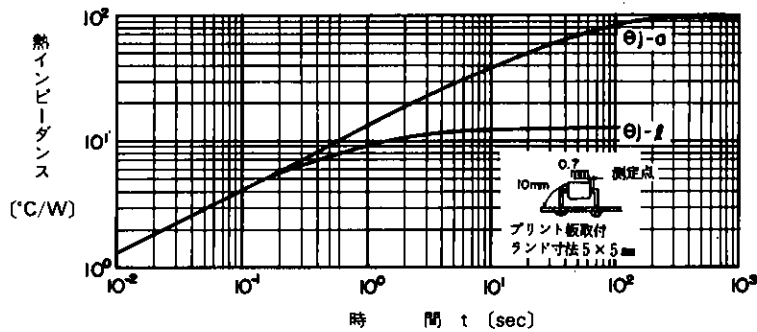

過渡熱インピーダンス  
Transient Thermal Impedance

For more information, contact:

**Collmer Semiconductor, Inc.**

P.O. Box 702708

Dallas, TX 75370

972-233-1589

972-233-0481 Fax

<http://www.collmer.com>