

74LVT2244 • 74LVTH2244

Low Voltage Octal Buffer/Line Driver with 3-STATE Outputs and 25Ω Series Resistors in the Outputs

General Description

The LVT2244 and LVTH2244 are octal buffers and line drivers designed to be employed as memory address drivers, clock drivers and bus oriented transmitters or receivers which provides improved PC board density. The equivalent 25Ω-Series resistors helps reduce output overshoot and undershoot.

The LVTH2244 data inputs include bushold, eliminating the need for external pull-up resistors to hold unused inputs.

These octal buffers and line drivers are designed for low-voltage (3.3V) V_{CC} applications, but with the capability to provide a TTL interface to a 5V environment. The LVT2244 and LVTH2244 are fabricated with an advanced BiCMOS technology to achieve high speed operation similar to 5V ABT while maintaining low power dissipation.

Features

- Input and output interface capability to systems at 5V V_{CC}
- Equivalent 25Ω-Series resistors on outputs
- Bushold data inputs eliminate the need for external pull-up resistors to hold unused inputs (74LVTH2244), also available without bushold feature (74LVT2244).
- Live insertion/extraction permitted
- Power Up/Down high impedance provides glitch-free bus loading
- Outputs source/sink -12 mA/+12 mA
- Latch-up performance exceeds 500 mA
- ESD performance:
 - Human-body model > 2000V
 - Machine model > 200V
 - Charged-device model > 1000V

Ordering Code:

Order Number	Package Number	Package Description
74LVT2244WM	M20B	20-Lead Small Outline Integrated Circuit (SOIC), JEDEC MS-013, 0.300" Wide
74LVT2244SJ	M20D	Pb-Free 20-Lead Small Outline Package (SOP), EIAJ TYPE II, 5.3mm Wide
74LVT2244MTC	MTC20	20-Lead Thin Shrink Small Outline Package (TSSOP), JEDEC MO-153, 4.4mm Wide
74LVT2244MTCX_NL (Note 1)	MTC20	Pb-Free 20-Lead Thin Shrink Small Outline Package (TSSOP), JEDEC MO-153, 4.4mm Wide
74LVTH2244WM	M20B	20-Lead Small Outline Integrated Circuit (SOIC), JEDEC MS-013, 0.300" Wide
74LVTH2244SJ	M20D	Pb-Free 20-Lead Small Outline Package (SOP), EIAJ TYPE II, 5.3mm Wide
74LVTH2244MTC	MTC20	20-Lead Thin Shrink Small Outline Package (TSSOP), JEDEC MO-153, 4.4mm Wide
74LVTH2244MTCX_NL (Note 1)	MTC20	Pb-Free 20-Lead Thin Shrink Small Outline Package (TSSOP), JEDEC MO-153, 4.4mm Wide

Devices also available in Tape and Reel. Specify by appending the suffix letter "X" to the ordering code.

Pb-Free package per JEDEC J-STD-020B.

Note 1: "_NL" indicates Pb-Free package (per JEDEC J-STD-020B). Device available in Tape and Reel only.

Logic Symbol

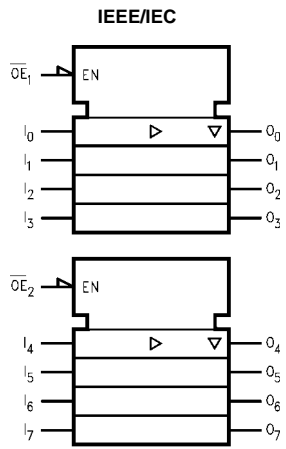

Connection Diagram

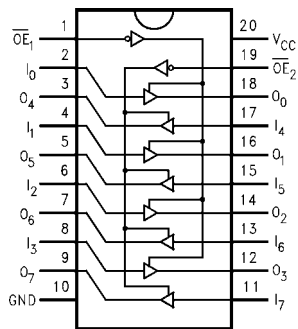

Pin Descriptions

Pin Names	Description
$\overline{OE}_1, \overline{OE}_2$	3-STATE Output Enable Inputs
I_0-I_7	Inputs
O_0-O_7	Outputs

Truth Tables

Inputs		Outputs (Pins 12, 14, 16, 18)
\overline{OE}_1	I_n	
L	L	L
L	H	H
H	X	Z

Inputs		Outputs (Pins 3, 5, 7, 9)
\overline{OE}_2	I_n	
L	L	L
L	H	H
H	X	Z

H = HIGH Voltage Level
 L = LOW Voltage Level
 X = Immaterial
 Z = High Impedance

Absolute Maximum Ratings ^(Note 2)					
Symbol	Parameter	Value	Conditions	Units	
V _{CC}	Supply Voltage	-0.5 to +4.6		V	
V _I	DC Input Voltage	-0.5 to +7.0		V	
V _O	DC Output Voltage	-0.5 to +7.0	Output in 3-STATE	V	
		-0.5 to +7.0	Output in HIGH or LOW State (Note 3)	V	
I _{IK}	DC Input Diode Current	-50	V _I < GND	mA	
I _{OK}	DC Output Diode Current	-50	V _O < GND	mA	
I _O	DC Output Current	64	V _O > V _{CC} Output at HIGH State	mA	
		128	V _O > V _{CC} Output at LOW State	mA	
I _{CC}	DC Supply Current per Supply Pin	±64		mA	
I _{GND}	DC Ground Current per Ground Pin	±128		mA	
T _{STG}	Storage Temperature	-65 to +150		°C	

Recommended Operating Conditions					
Symbol	Parameter	Min	Max	Units	
V _{CC}	Supply Voltage	2.7	3.6	V	
V _I	Input Voltage	0	5.5	V	
I _{OH}	HIGH-Level Output Current		-12	mA	
I _{OL}	LOW-Level Output Current		12	mA	
T _A	Free-Air Operating Temperature	-40	85	°C	
Δt/ΔV	Input Edge Rate, V _{IN} = 0.8V–2.0V, V _{CC} = 3.0V	0	10	ns/V	

Note 2: Absolute Maximum continuous ratings are those values beyond which damage to the device may occur. Exposure to these conditions or conditions beyond those indicated may adversely affect device reliability. Functional operation under absolute maximum rated conditions is not implied.

Note 3: I_O Absolute Maximum Rating must be observed.

DC Electrical Characteristics

Symbol	Parameter	V _{CC} (V)	T _A = -40°C to +85°C			Units	Conditions	
			Min	Typ (Note 4)	Max			
V _{IK}	Input Clamp Diode Voltage	2.7			-1.2	V	I _I = -18 mA	
V _{IH}	Input HIGH Voltage	2.7–3.6	2.0			V	V _O ≤ 0.1V or V _O ≥ V _{CC} - 0.1V	
V _{IL}	Input LOW Voltage	2.7–3.6			0.8	V		
V _{OH}	Output HIGH Voltage	2.7–3.6	V _{CC} - 0.2			V	I _{OH} = -100 μA	
		3.0	2.0			V	I _{OH} = -12 mA	
V _{OL}	Output LOW Voltage	2.7			0.2	V	I _{OL} = 100 μA	
		3.0			0.8	V	I _{OL} = 12 mA	
I _{I(HOLD)} (Note 5)	Bushold Input Minimum Drive	3.0	75			μA	V _I = 0.8V	
			-75			μA	V _I = 2.0V	
I _{I(OD)} (Note 5)	Bushold Input Over-Drive Current to Change State	3.0	500			μA	(Note 6)	
			-500			μA	(Note 7)	
I _I	Input Current	3.6			10	μA	V _I = 5.5V	
			Control Pins	3.6		±1	μA	V _I = 0V or V _{CC}
			Data Pins	3.6		-5	μA	V _I = 0V
I _{OFF}	Power Off Leakage Current	0			±100	μA	0V ≤ V _I or V _O ≤ 5.5V	
I _{PU/PD}	Power up/down 3-STATE Output Current	0–1.5V			±100	μA	V _O = 0.5V to 3.0V V _I = GND or V _{CC}	
I _{OZL}	3-STATE Output Leakage Current	3.6			-5	μA	V _O = 0.5V	
I _{OZH}	3-STATE Output Leakage Current	3.6			5	μA	V _O = 3.0V	
I _{OZH+}	3-STATE Output Leakage Current	3.6			10	μA	V _{CC} < V _O ≤ 5.5V	
I _{CCH}	Power Supply Current	3.6			0.19	mA	Outputs HIGH	
I _{CCL}	Power Supply Current	3.6			5	mA	Outputs LOW	
I _{CCZ}	Power Supply Current	3.6			0.19	mA	Outputs Disabled	

DC Electrical Characteristics (Continued)

Symbol	Parameter	V _{CC} (V)	T _A = -40°C to +85°C			Units	Conditions
			Min	Typ (Note 4)	Max		
I _{CCZ} ⁺	Power Supply Current	3.6			0.19	mA	V _{CC} ≤ V _O ≤ 5.5V, Outputs Disabled
ΔI _{CC}	Increase in Power Supply Current (Note 8)	3.6			0.2	mA	One Input at V _{CC} - 0.6V Other Inputs at V _{CC} or GND

Note 4: All typical values are at V_{CC} = 3.3V, T_A = 25°C.

Note 5: Applies to bushold versions only (74LVTH2244).

Note 6: An external driver must source at least the specified current to switch from LOW-to-HIGH.

Note 7: An external driver must sink at least the specified current to switch from HIGH-to-LOW.

Note 8: This is the increase in supply current for each, input that is at the specified voltage level rather than V_{CC} or GND.

Dynamic Switching Characteristics (Note 9)

Symbol	Parameter	V _{CC} (V)	T _A = 25°C			Units	Conditions C _L = 50 pF, R _L = 500Ω
			Min	Typ	Max		
V _{OLP}	Quiet Output Maximum Dynamic V _{OL}	3.3		0.8		V	(Note 10)
V _{OLV}	Quiet Output Minimum Dynamic V _{OL}	3.3		-0.8		V	

Note 9: Characterized in SOIC package. Guaranteed parameter, but not tested.

Note 10: Max number of outputs defined as (n). n-1 data inputs are driven 0V to 3V. Output under test held LOW.

AC Electrical Characteristics

Symbol	Parameter	T _A = -40°C to +85°C C _L = 50 pF, R _L = 500Ω					Units
		V _{CC} = 3.3V ± 0.3V			V _{CC} = 2.7V		
		Min	Typ (Note 11)	Max	Min	Max	
t _{PLH}	Propagation Delay Data to Output	1.0		4.4	1.0	5.3	ns
t _{PHL}		1.0		4.1	1.0	4.4	
t _{PZH}	Output Enable Time	1.0		5.9	1.0	7.7	ns
t _{PZL}		1.1		5.5	1.1	6.2	
t _{PHZ}	Output Disable Time	1.9		6.1	1.9	6.8	ns
t _{PLZ}		1.8		4.5	1.8	4.5	
t _{OSSL}	Output to Output Skew (Note 12)			1.0		1.0	ns
t _{OSLH}							

Note 11: All typical values are at V_{CC} = 3.3V, T_A = 25°C.

Note 12: Skew is defined as the absolute value of the difference between the actual propagation delay for any two separate outputs of the same device. The specification applies to any outputs switching in the same direction, either HIGH-to-LOW (t_{OSSL}) or LOW-to-HIGH (t_{OSLH}).

Capacitance (Note 13)

Symbol	Parameter	Conditions	Typical	Units
C _{IN}	Input Capacitance	V _{CC} = 0V, V _I = 0V or V _{CC}	3	pF
C _{OUT}	Output Capacitance	V _{CC} = 3.0V, V _O = 0V or V _{CC}	6	pF

Note 13: Capacitance is measured at frequency f = 1 MHz, per MIL-STD-883B, Method 3012.

Physical Dimensions inches (millimeters) unless otherwise noted

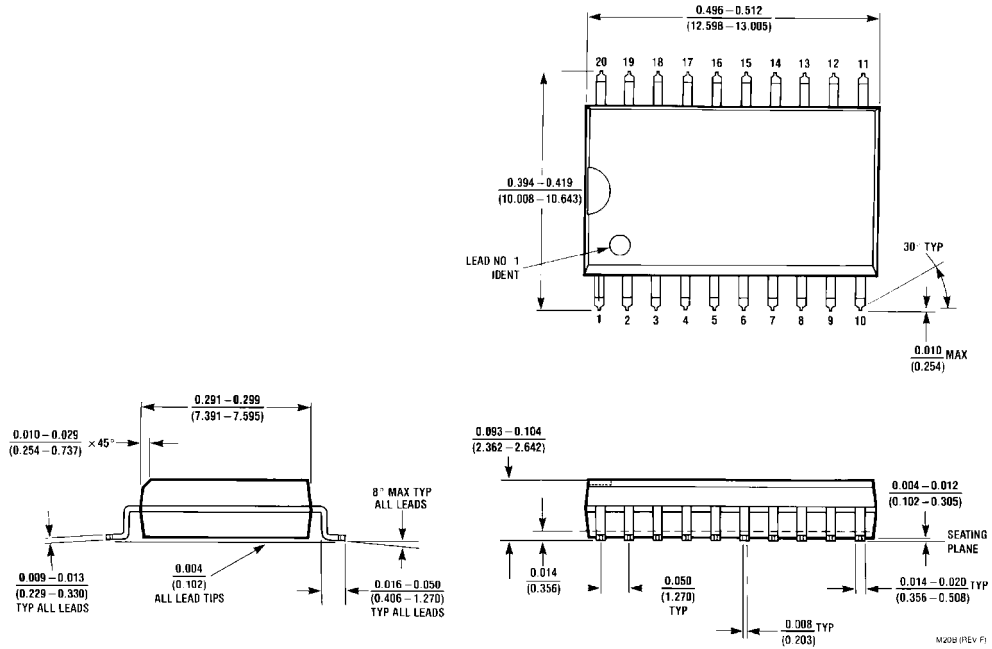

**20-Lead Small Outline Integrated Circuit (SOIC), JEDEC MS-013, 0.300" Wide
Package Number M20B**

Physical Dimensions inches (millimeters) unless otherwise noted (Continued)

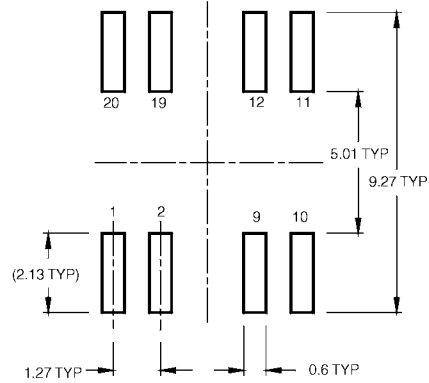
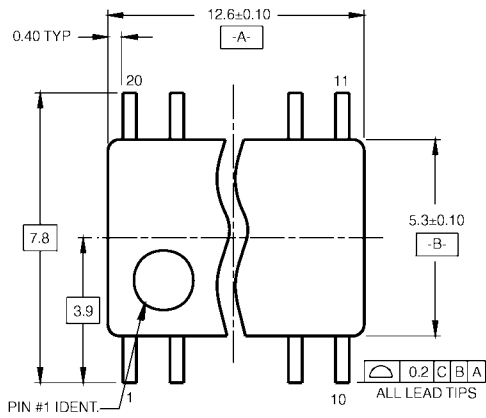

LAND PATTERN RECOMMENDATION

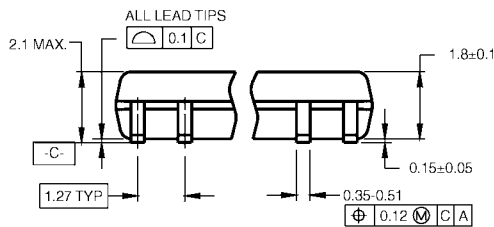

DIMENSIONS ARE IN MILLIMETERS

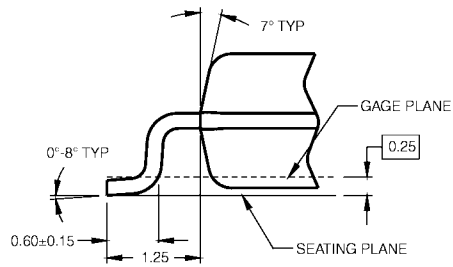

DETAIL A

NOTES:

- A. CONFORMS TO EIAJ EDR-7320 REGISTRATION, ESTABLISHED IN DECEMBER, 1998.
- B. DIMENSIONS ARE IN MILLIMETERS.
- C. DIMENSIONS ARE EXCLUSIVE OF BURRS, MOLD FLASH, AND TIE BAR EXTRUSIONS.

M20DRevB1

Pb-Free 20-Lead Small Outline Package (SOP), EIAJ TYPE II, 5.3mm Wide Package Number M20D

Physical Dimensions inches (millimeters) unless otherwise noted (Continued)

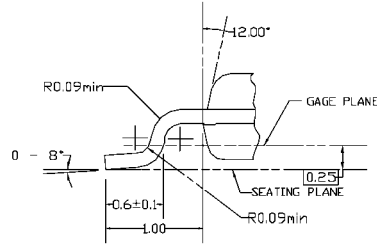
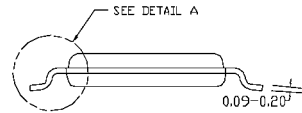
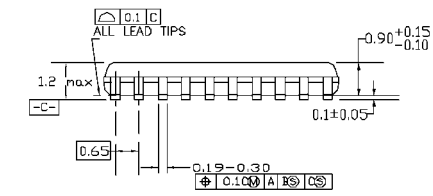
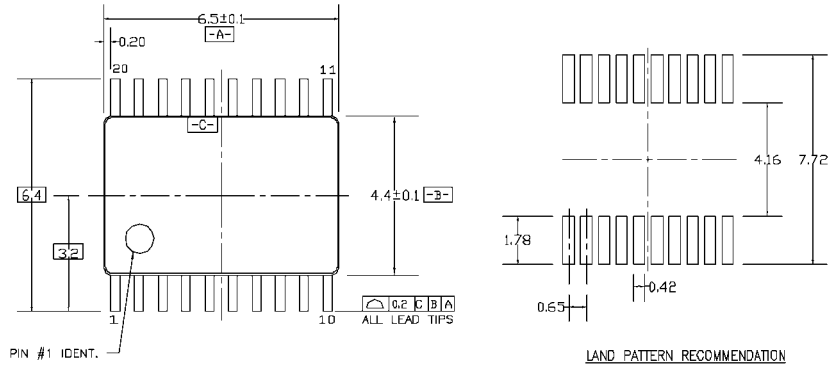

DIMENSIONS ARE IN MILLIMETERS

NOTES:

- A. CONFORMS TO JEDEC REGISTRATION MO-153, VARIATION AC, REF NOTE 6, DATE 7/93.
- B. DIMENSIONS ARE IN MILLIMETERS.
- C. DIMENSIONS ARE EXCLUSIVE OF BURRS, MOLDS FLASH, AND TIE BAR EXTRUSIONS.
- D. DIMENSIONS AND TOLERANCES PER ANSI Y14.5M, 1982.

MTC20REV D1

20-Lead Thin Shrink Small Outline Package (TSSOP), JEDEC MO-153, 4.4mm Wide Package Number MTC20

Fairchild does not assume any responsibility for use of any circuitry described, no circuit patent licenses are implied and Fairchild reserves the right at any time without notice to change said circuitry and specifications.

LIFE SUPPORT POLICY

FAIRCHILD'S PRODUCTS ARE NOT AUTHORIZED FOR USE AS CRITICAL COMPONENTS IN LIFE SUPPORT DEVICES OR SYSTEMS WITHOUT THE EXPRESS WRITTEN APPROVAL OF THE PRESIDENT OF FAIRCHILD SEMICONDUCTOR CORPORATION. As used herein:

1. Life support devices or systems are devices or systems which, (a) are intended for surgical implant into the body, or (b) support or sustain life, and (c) whose failure to perform when properly used in accordance with instructions for use provided in the labeling, can be reasonably expected to result in a significant injury to the user.
2. A critical component in any component of a life support device or system whose failure to perform can be reasonably expected to cause the failure of the life support device or system, or to affect its safety or effectiveness.

www.fairchildsemi.com