

Technische Information / Technical Information

eupec

Netz Gleichrichterdiode
Rectifier Diode

D 1709 N 20...24

N



Elektrische Eigenschaften / Electrical properties

Höchstzulässige Werte / Maximum rated values

Periodische Spitzensperrspannung repetitive peak forward reverse voltage	$T_{vj} = -40^{\circ}\text{C} \dots T_{vj \max}$	V_{RRM}	2000 2200 2400	V V V
Stoßspitzensperrspannung non-repetitive peak reverse voltage	$T_{vj} = +25^{\circ}\text{C} \dots T_{vj \max}$	V_{RSM}	2100 2300 2500	V V V
Durchlaßstrom-Grenzeffektivwert RMS forward current		I_{FRMSM}	2700	A
Dauergrenzstrom mean forward current	$T_C = 90^{\circ}\text{C}$	I_{FAVM}	1700	A
Stoßstrom-Grenzwert surge forward current	$T_{vj} = 25^{\circ}\text{C}, t_p = 10 \text{ ms}$ $T_{vj} = T_{vj \max}, t_p = 10 \text{ ms}$	I_{FSM}	21.500 18.000	A A
Grenzlastintegral I^2t -value	$T_{vj} = 25^{\circ}\text{C}, t_p = 10 \text{ ms}$ $T_{vj} = T_{vj \max}, t_p = 10 \text{ ms}$	I^2t	2.311 1.620	$\text{A}^2\text{s} \cdot 10^3$ $\text{A}^2\text{s} \cdot 10^5$

Charakteristische Werte / Characteristic values

Durchlaßspannung forward voltage	$T_{vj} = T_{vj \max}, i_F = 4 \text{ kA}$	V_F	max. 1,8	V
	$T_{vj} = T_{vj \max}, i_F = 700 \text{ A}$	V_F	max. 0,98	V
Schleusenspannung threshold voltage	$T_{vj} = T_{vj \max}$	$V_{(TO)}$	0,83	V
Ersatzwiderstand forward slope resistance	$T_{vj} = T_{vj \max}$	r_T	0,20	m Ω
Durchlaßkennlinie on-state voltage $v_T = A + B \cdot i_T + C \cdot \ln(i_T + 1) + D \cdot \sqrt{i_T}$	$T_{vj} = T_{vj \max}$	$T_{vj} = 25^{\circ}\text{C}$		
	A = 6,4014E-01	7,2964E-01		
	B = 1,2359E-04	8,9772E-06		
	C = -1,0606E-02	5,9894E-03		
	D = 1,2090E-02	8,4835E-03		
Sperrstrom reverse current	$T_{vj} = T_{vj \max}, V_R = V_{RRM}$	i_R	max. 60	mA

Thermische Eigenschaften / Thermal properties

Innerer Wärmewiderstand thermal resistance, junction to case	Kühlfläche / cooling surface beidseitig / two-sided, $\Theta = 180^{\circ}\text{sin}$ beidseitig / two-sided, DC Anode / anode, $\Theta = 180^{\circ}\text{sin}$ Anode / anode, DC Kathode / cathode, $\Theta = 180^{\circ}\text{sin}$ Kathode / cathode, DC	R_{thJC}	max. 0,0245	$^{\circ}\text{C/W}$
			max. 0,0223	$^{\circ}\text{C/W}$
			max. 0,0410	$^{\circ}\text{C/W}$
			max. 0,0388	$^{\circ}\text{C/W}$
			max. 0,0540	$^{\circ}\text{C/W}$
			max. 0,0514	$^{\circ}\text{C/W}$
Übergangs- Wärmewiderstand thermal resistance, case to heatsink	Kühlfläche / cooling surface beidseitig / two-sided einseitig / single-sided	R_{thJK}	max. 0,0035	$^{\circ}\text{C/W}$
			max. 0,0070	$^{\circ}\text{C/W}$
Höchstzulässige Sperrschichttemperatur max. junction temperature		$T_{vj \max}$	160	$^{\circ}\text{C}$
Betriebstemperatur operating temperature		$T_{c \text{ op}}$	-40...+150	$^{\circ}\text{C}$
Lagertemperatur storage temperature		T_{stg}	-40...+150	$^{\circ}\text{C}$

prepared by: K.A.Rüther

data of publication:

BIP AM

approved by: J. Novotny

revision: 1

A20/00

Seite/page 1



Mechanische Eigenschaften / Mechanical properties

Gehäuse, siehe Anlage case, see appendix			Seite 3 page 3	
Si-Element mit Druckkontakt Si-pellet with pressure contact				
Anpreßkraft clamping force		F	12...24	kN
Gewicht weight		G	typ. 540	g
Kriechstrecke creepage distance			32	mm
Feuchteklasse humidity classification	DIN 40040		C	
Schwingfestigkeit vibration resistance	f = 50Hz		50	m/s ²

Kühlkörper/heatsinks : K0.05F 400 W

Mit dieser technischen Information werden Halbleiterbauelemente spezifiziert, jedoch keine Eigenschaften zugesichert. Sie gilt in Verbindung mit den zugehörigen Technischen Erläuterungen./ The technical information specifies semiconductor devices but promises no characteristics. It is valid in combination with the belonging technical notes.

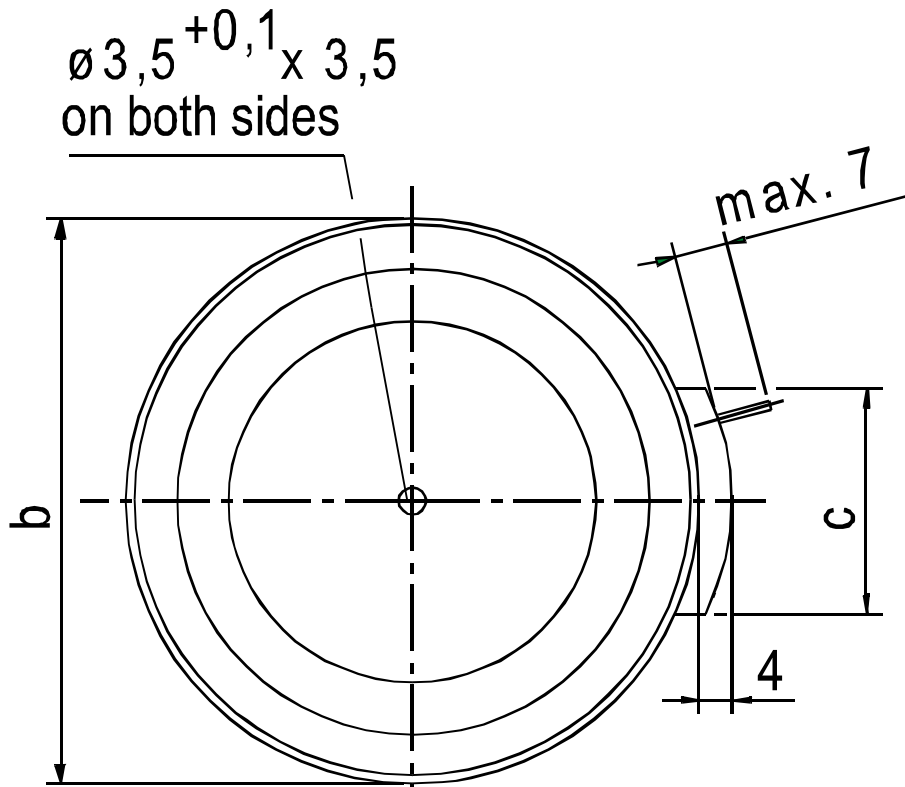
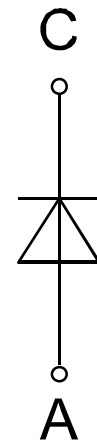
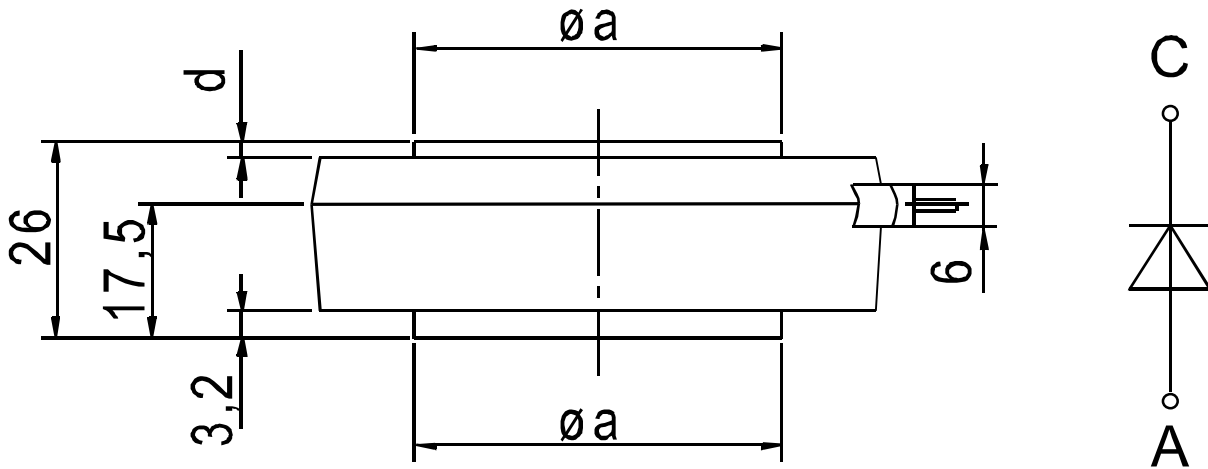

	I	II	
a	48	65	
b	75	100	
c	30	32	
d	2,3	3,0	

D 1709 N Type I



Kühlung cooling	Analytische Elemente des transienten Wärmewiderstandes Z_{thJC} für DC Analytical elements of transient thermal impedance Z_{thJC} for DC							
	Pos.n	1	2	3	4	5	6	7
beidseitig two-sided	R_{thn} [°C/W]	0,00114	0,0025	0,0031	0,00761	0,00795		
	τ_n [s]	0,00146	0,00563	0,0609	0,239	1,24		
anodenseitig anode-sided	R_{thn} [°C/W]	0,00111	0,00251	0,00331	0,00892	0,023		
	τ_n [s]	0,00144	0,00547	0,0611	0,276	4,3		
kathodenseitig cathode-sided	R_{thn} [°C/W]	0,00118	0,00269	0,00883	0,00329	0,0358		
	τ_n [s]	0,00147	0,00613	0,134	0,741	8,81		

Analytische Funktion / analytical function : $Z_{thJC} = \sum_{n=1}^{n_{max}} R_{thn} (1 - EXP (- t / \tau_n))$

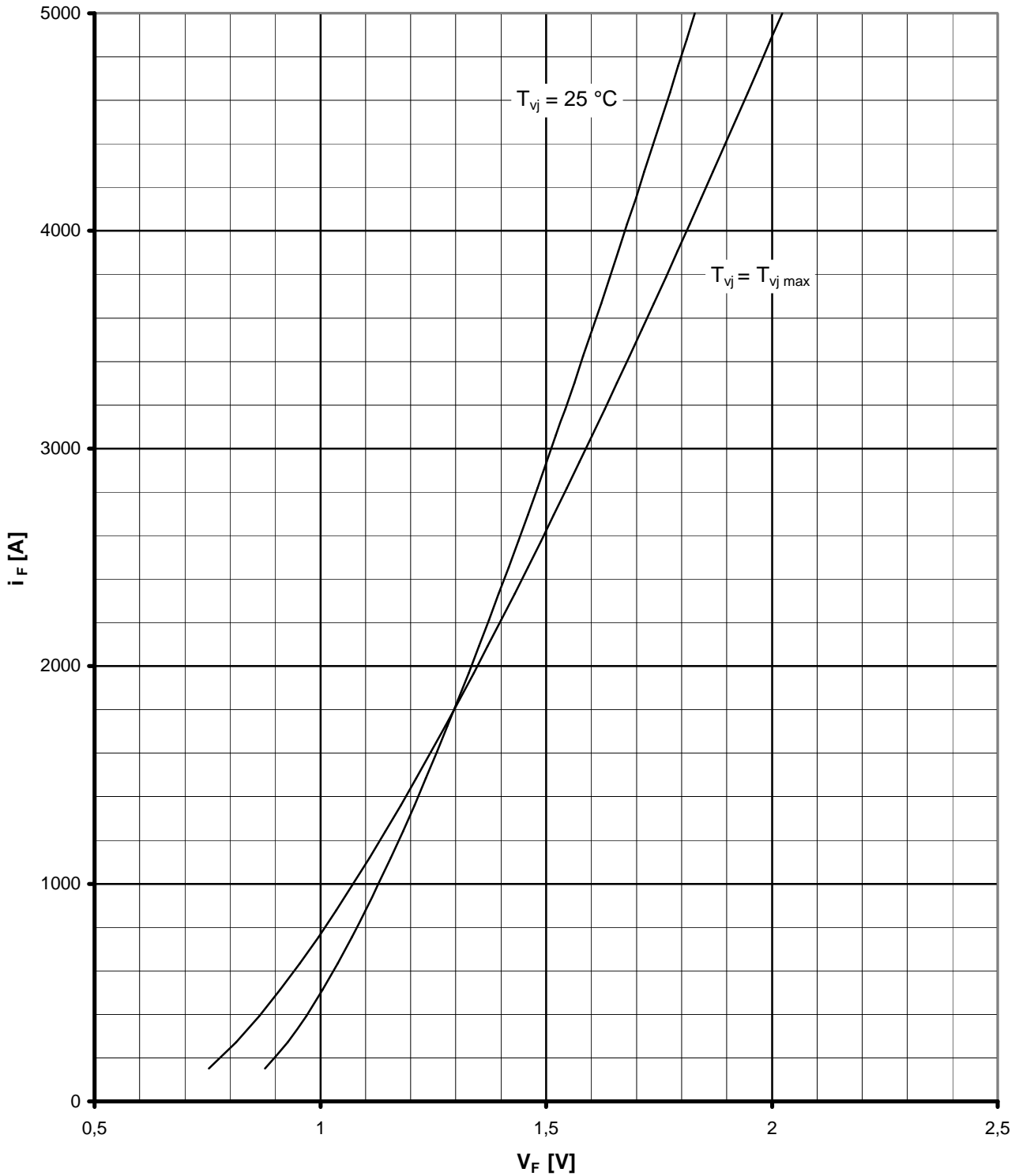

Grenzdurchlaßkennlinien / Limiting on-state characteristics $i_F = f(V_T)$

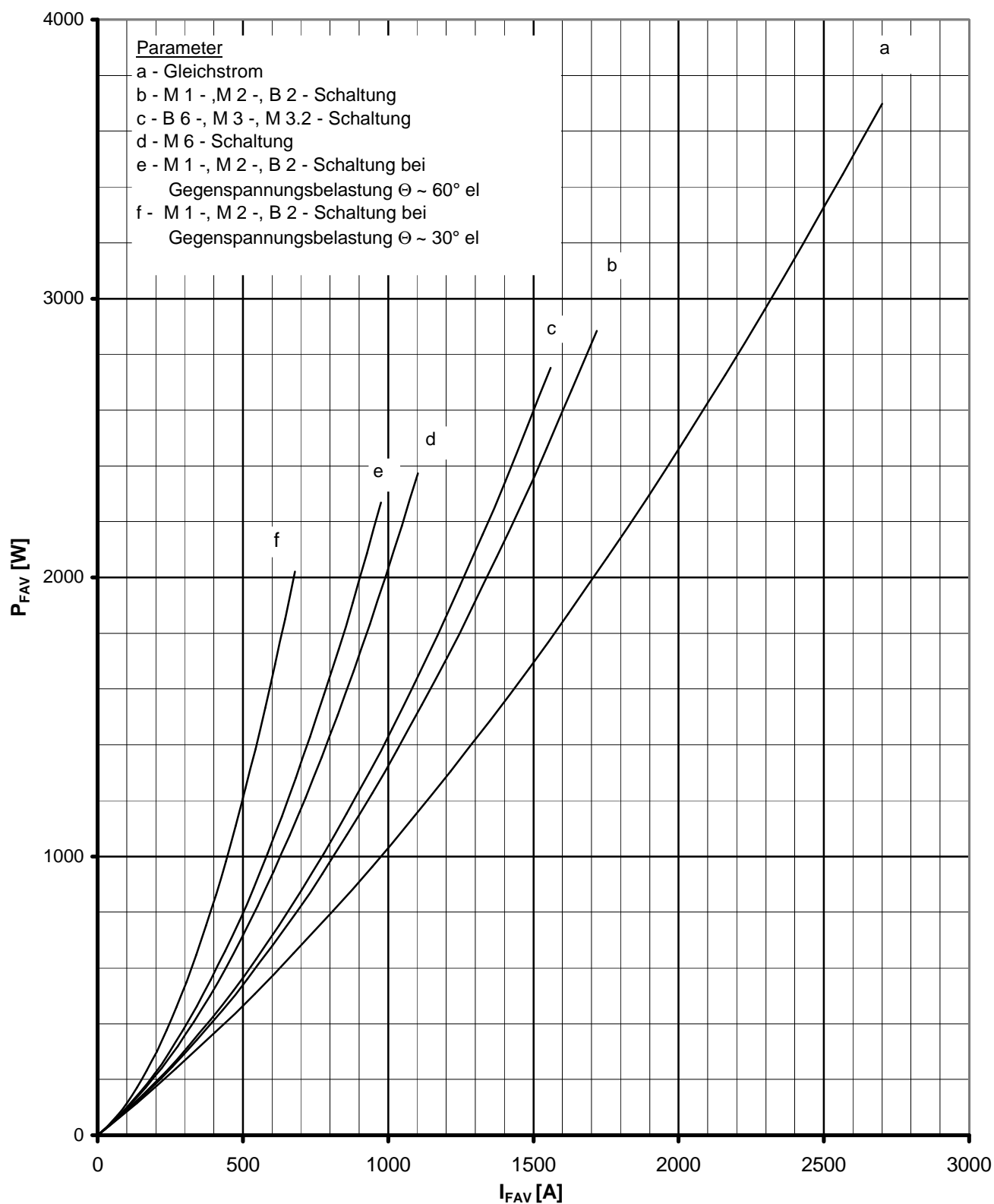

Durchlaßverlustleistung / On-state power loss $P_{FAV} = f(I_{FAV})$

Netz-Gleichrichterdiode
Rectifier Diode

D 1709 N 20...24

N

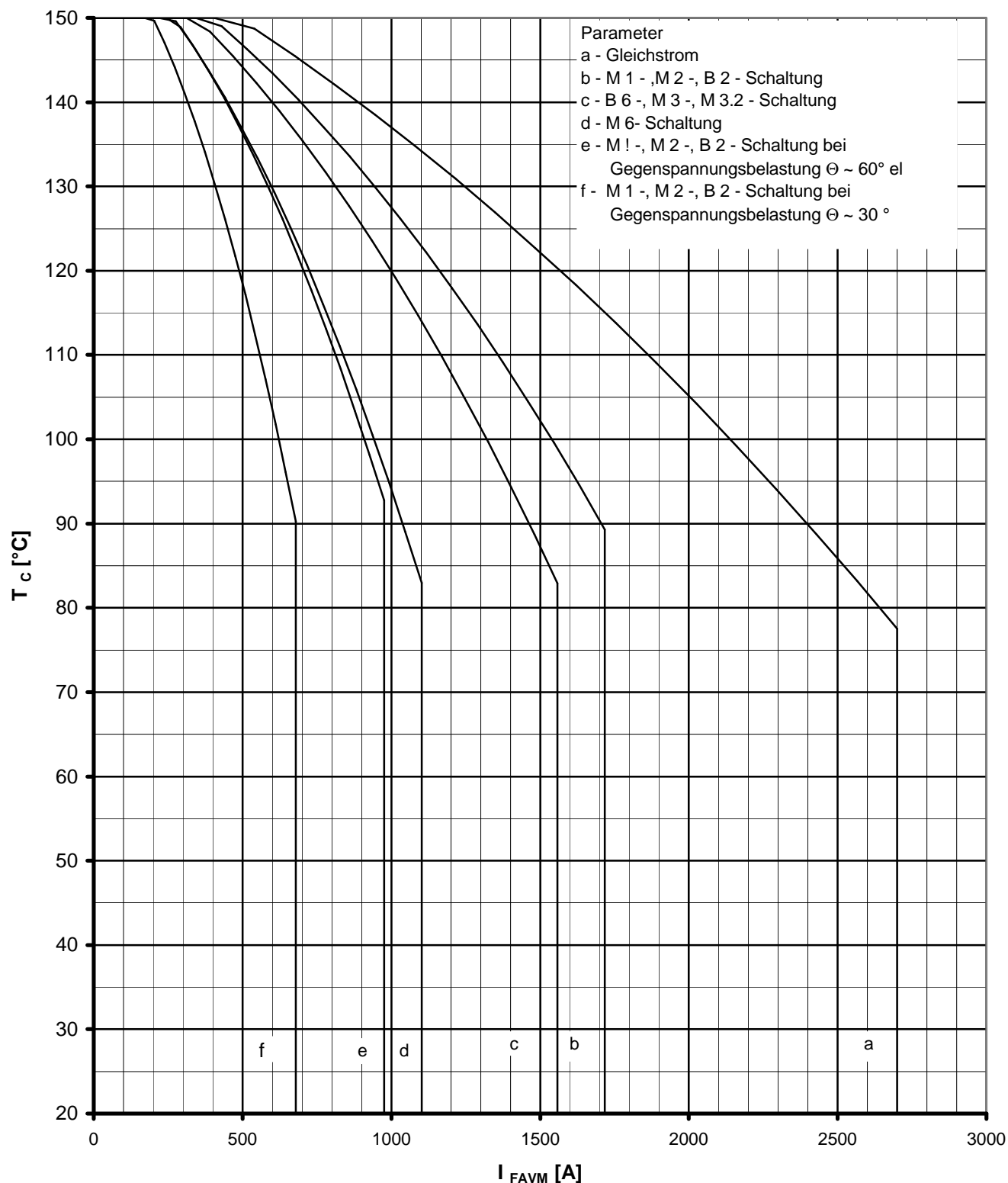

Höchstzulässige Gehäusetemperatur / Maximum allowable case temperature $T_C = f(I_{TAVM})$
Beidseitige Kühlung / Two-sided cooling

Netz-Gleichrichterdiode
Rectifier Diode

D 1709 N 20...24

N

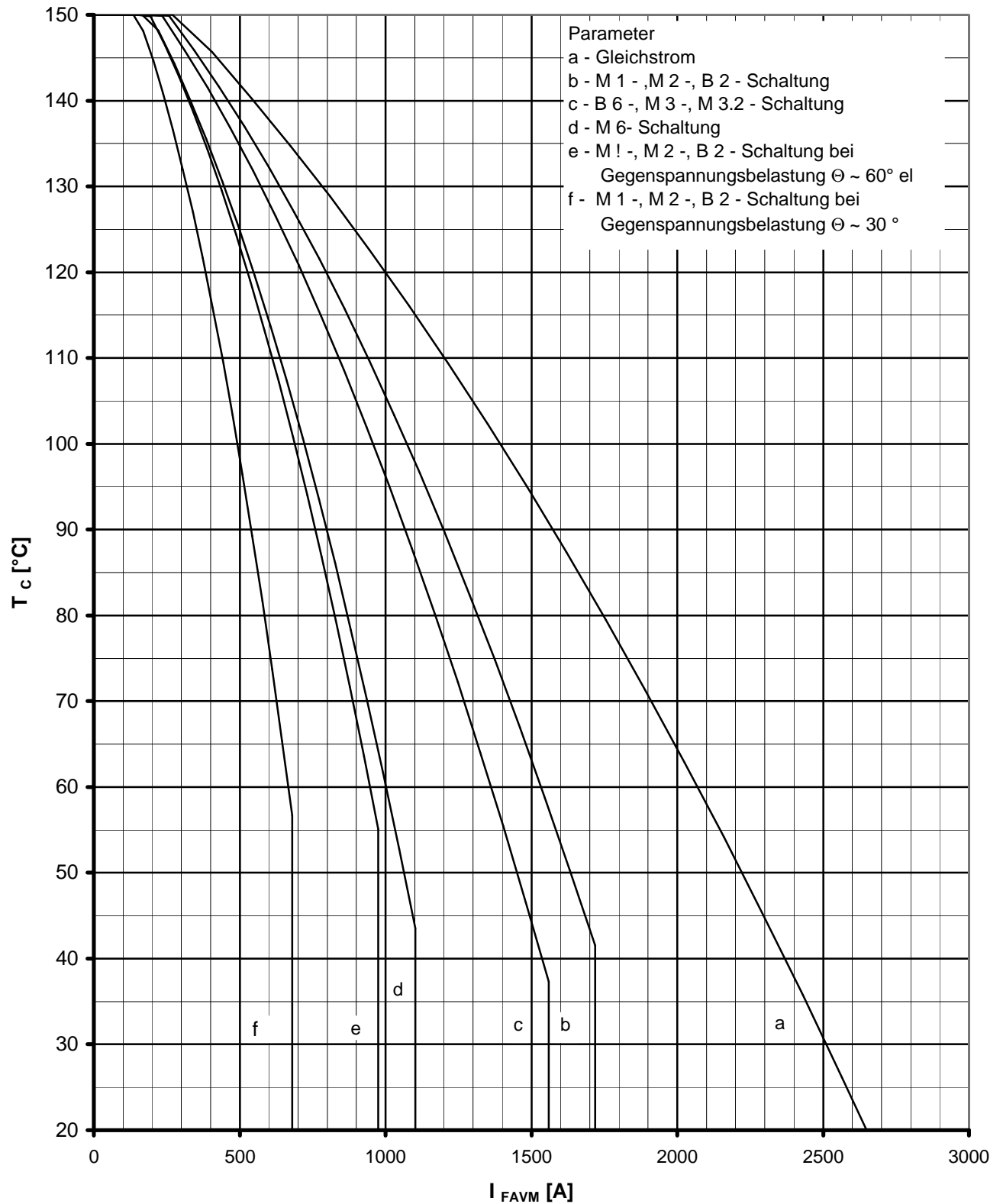

Höchstzulässige Gehäusetemperatur / Maximum allowable case temperature $T_C = f(I_{TAVM})$
Anodenseitige Kühlung / anode sided cooling

Netz-Gleichrichterdiode
Rectifier Diode

D 1709 N 20...24

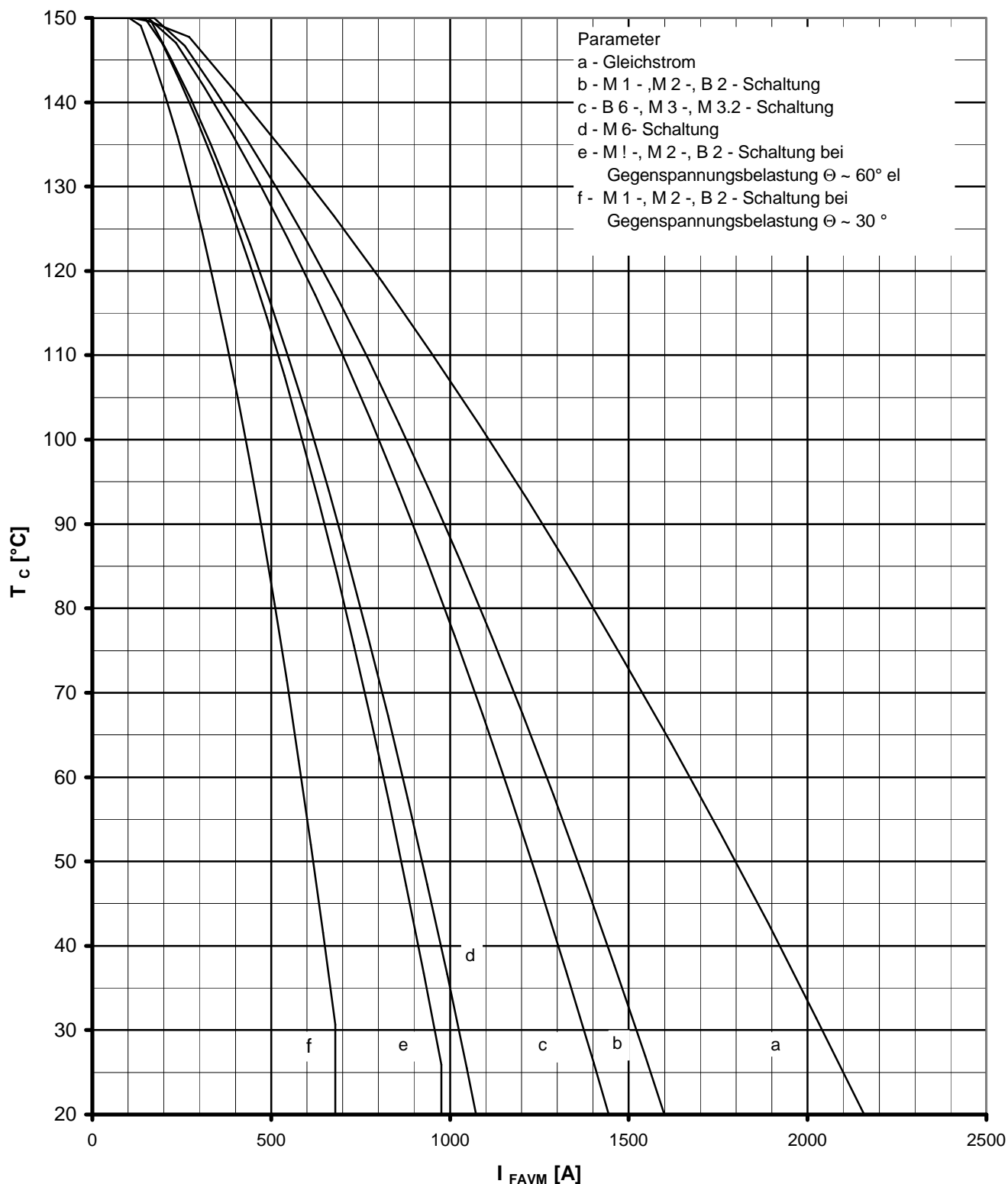
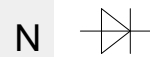

Höchstzulässige Gehäusetemperatur / Maximum allowable case temperature $T_c = f(I_{FAVM})$
Kathodenseitige Kühlung / cathode-sided cooling

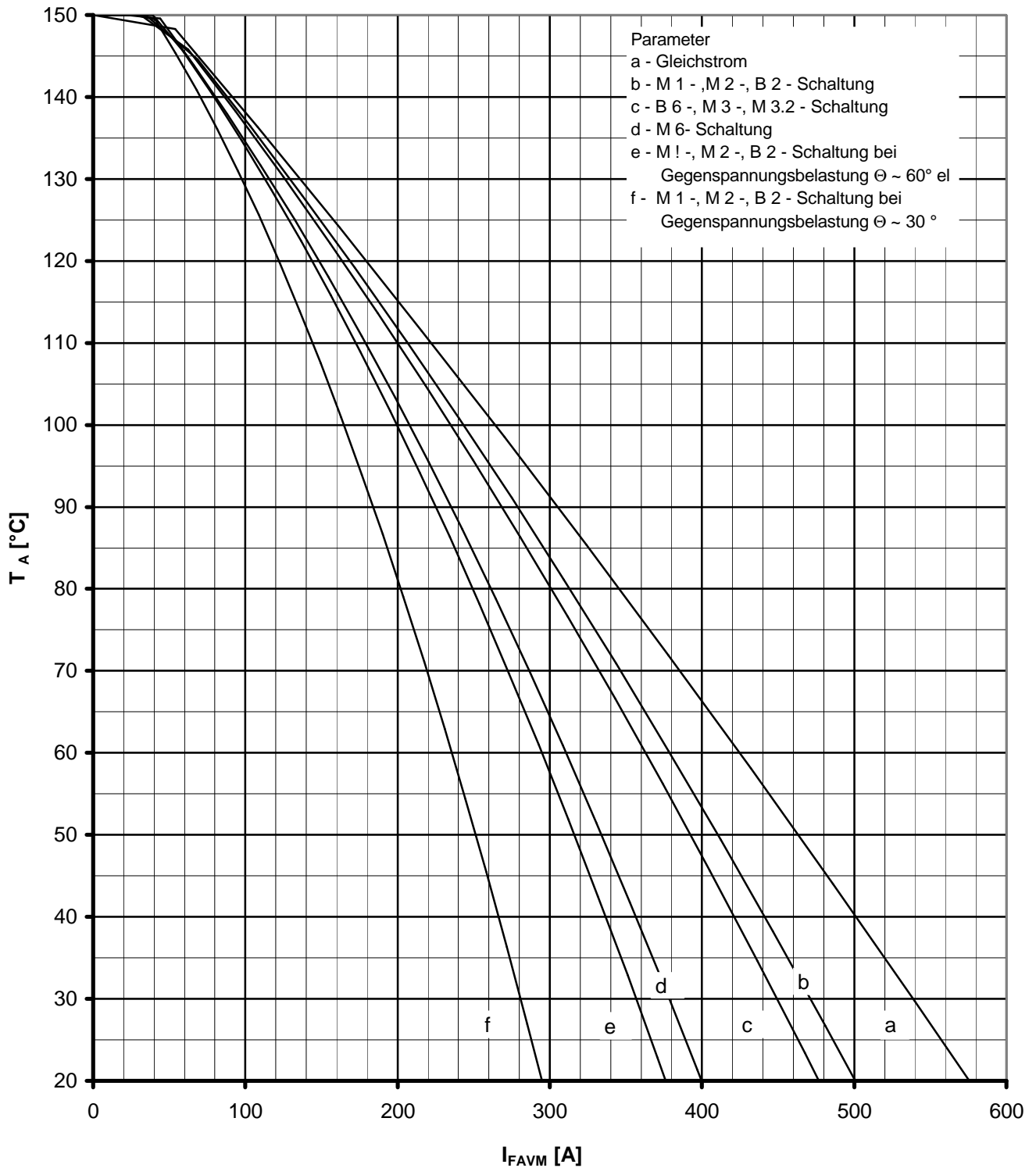

Höchstzulässige Kühlmitteltemperatur / max. allowable cooling medium temperature $T_A = f(I_{TAVM})$

Luftselbstkühlung / natural air-cooling

Kühlkörper / Heatsink K0.05F

Netz-Gleichrichterdiode
Rectifier Diode

D 1709 N 20...24

N

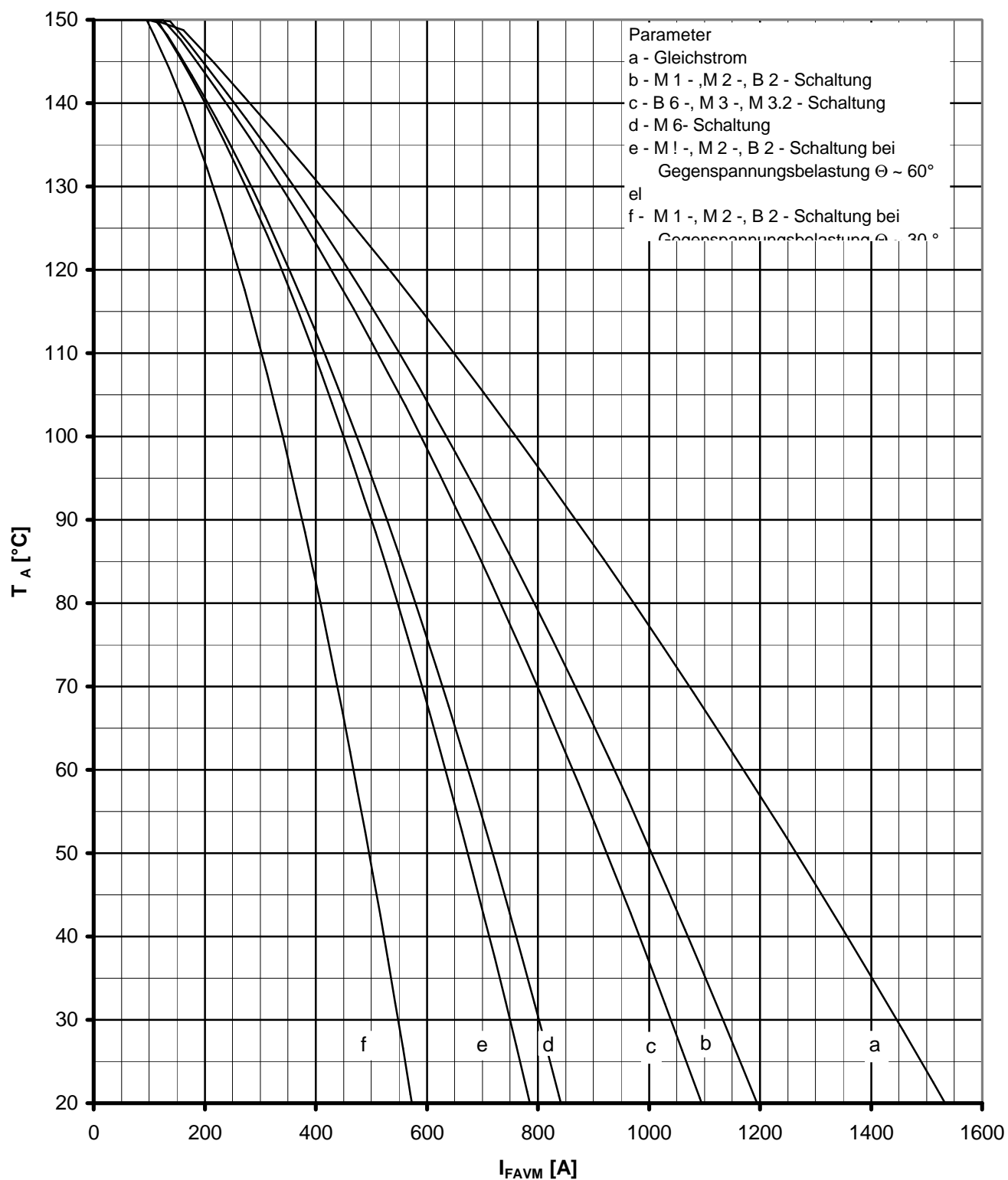

Höchstzulässige Kühlmitteltemperatur / max. allowable cooling medium temperature $T_A = f(I_{TAVM})$

Verstärkte Luftkühlung / Forced air-cooling

Kühlkörper / Heatsink K0.05F, $V_L = 120/s$

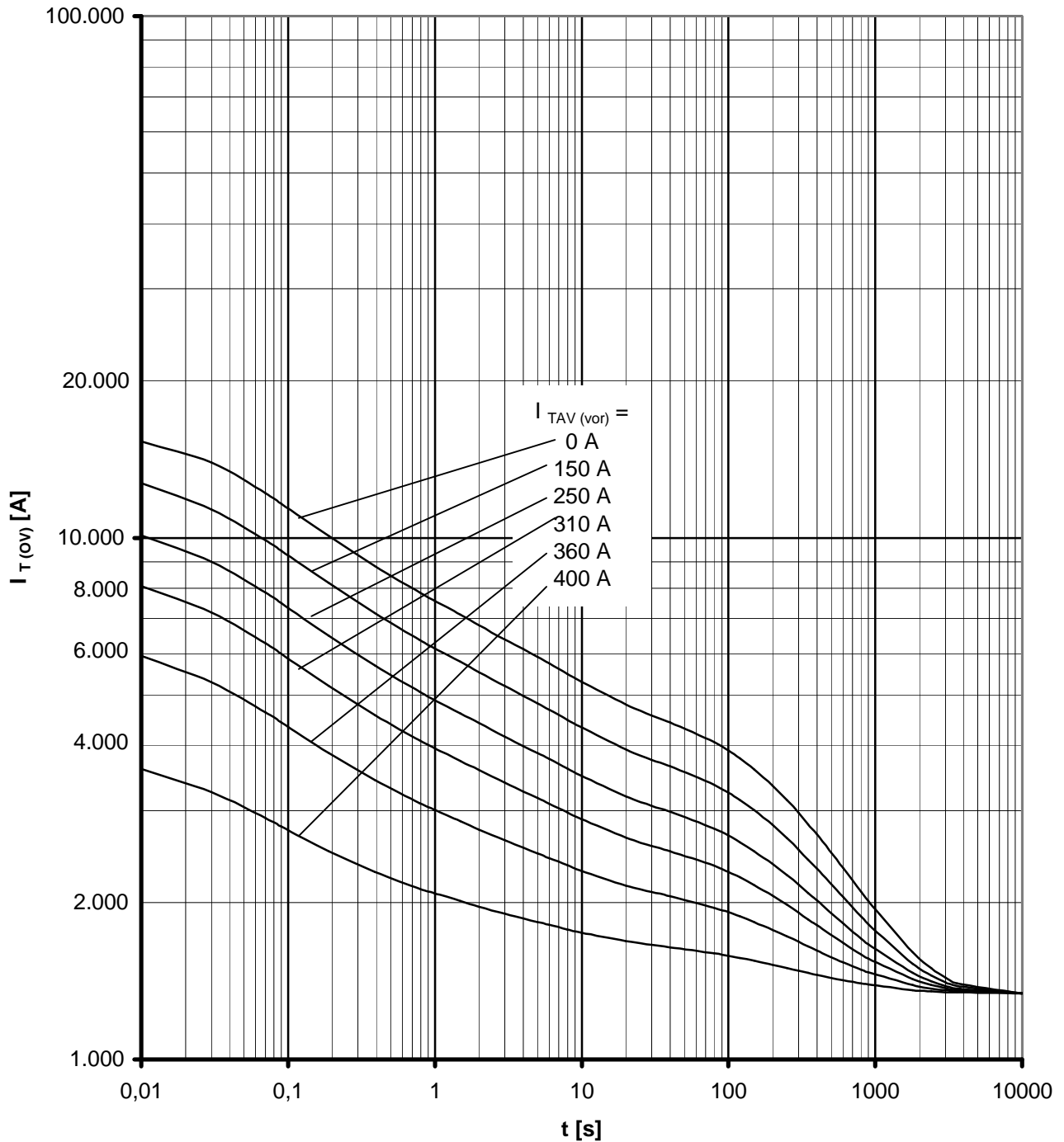

Überstrom / Overload on-state current $I_{T(OV)} = f(t)$

Beidseitige Luftselbstkühlung / Two-sided natural cooling K0.05F

$T_A = 45^\circ\text{C}$

Parameter: Vorlaststrom / pre-load current $I_{TAV(vor)}$

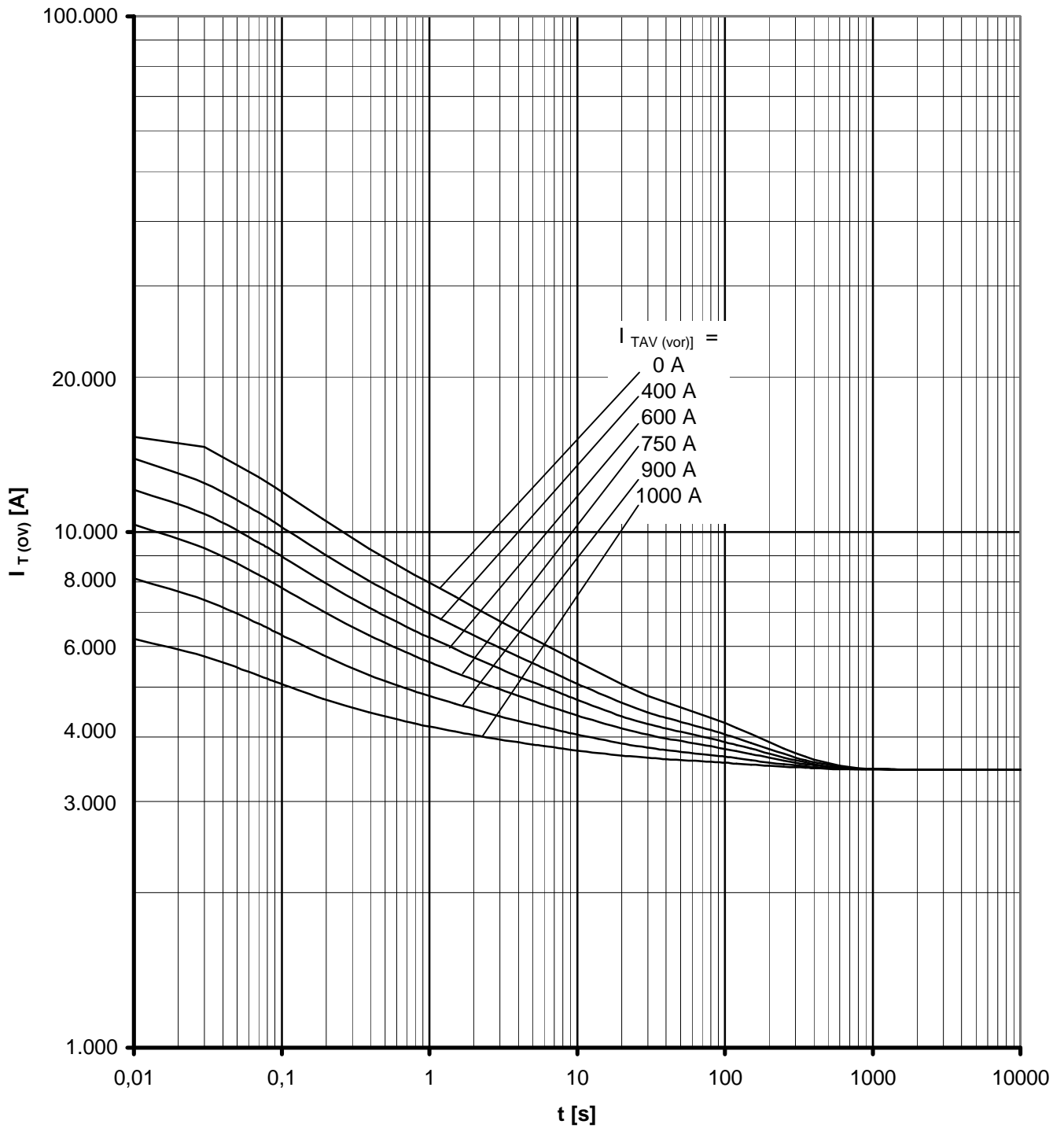

Überstrom / Overload on-state current $I_{T(OV)} = f(t)$

Beidseitige verstärkte Kühlung / forced two-sided cooling K0.05F

$T_A = 35^\circ\text{C}$, $V_L = 120 \text{ l/s}$

Parameter: Vorlaststrom / pre-load current $I_{TAV(vor)}$

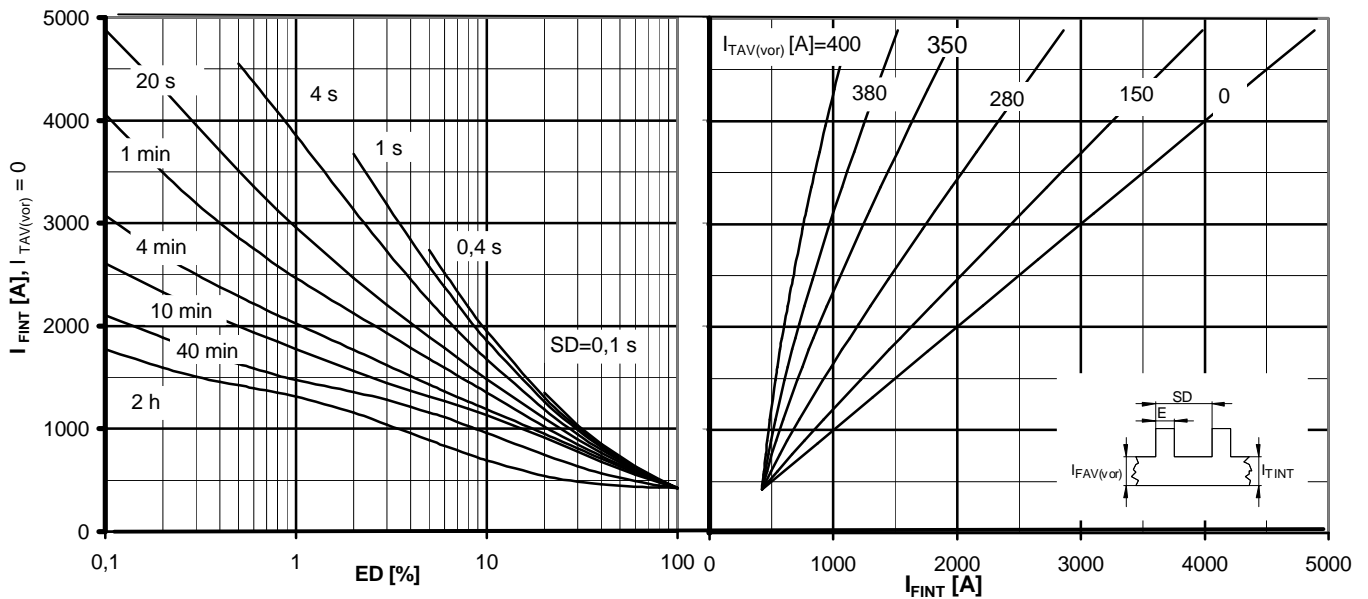

Höchstzul. Durchlaßstrom bei Ausetzbetrieb / Max. allowable on-state current during intermittent operation $I_{TINT} = f(ED)$

Beidseitig Luftselbstkühlung / two-sided natural cooling $K 0.05F$
 $T_A = 45\text{ °C}$

Parameter: Vorlaststrom / pre-load current $I_{TAV(vor)}$, Spieldauer / cycle duration SD

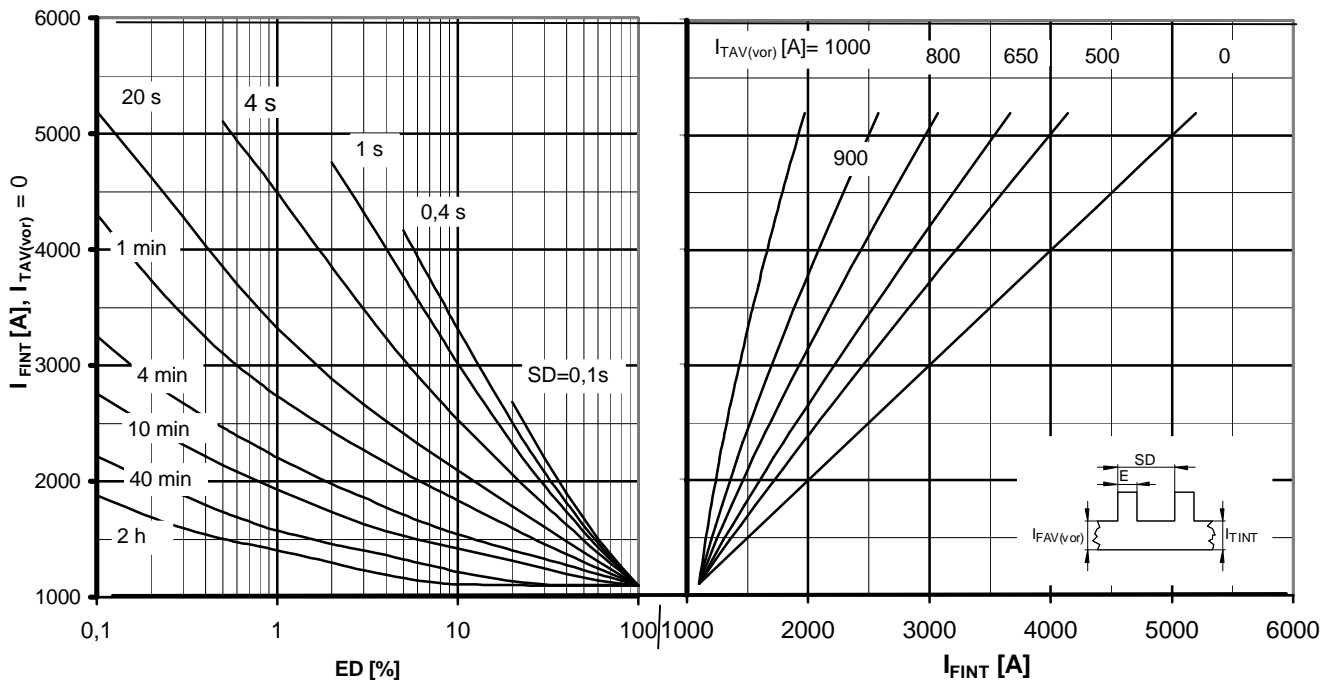

Höchstzul. Durchlaßstrom bei Ausetzbetrieb / Max. allowable on-state current during intermittent operation $I_{FINT} = f(ED)$

Beidseitig verstärkte Kühlung / forced two-sided cooling $K 0.05F$
 $T_A = 35\text{ °C}$, $V_L = 120\text{ l/s}$

Parameter: Vorlaststrom / pre-load current $I_{FAV(vor)}$, Spieldauer / cycle duration SD

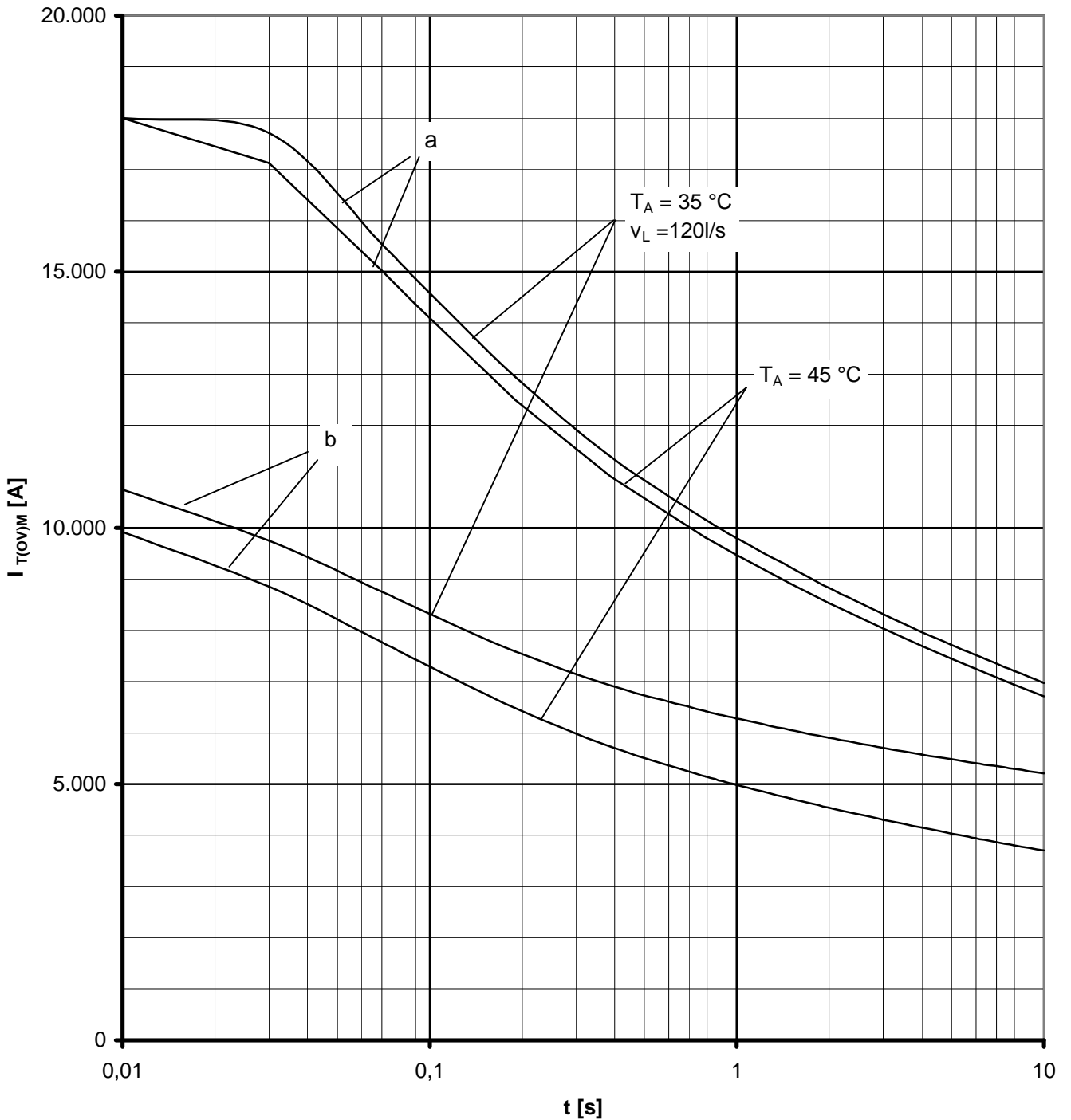

Grenzstrom / Max. overload on-state current $I_{T(OV)M} = f(t)$, $V_{RM} = 0,8 V_{RRM}$

Beidseitige Kühlung / Two-sided cooling

Kühlkörper / Heatsink: K 0.05F

Belastung aus / Surge current occurs:

a - Leerlauf / No-load conditions

b - Betrieb mit Dauergrenzstrom / During operation at max. average on-state current I_{TAVM}

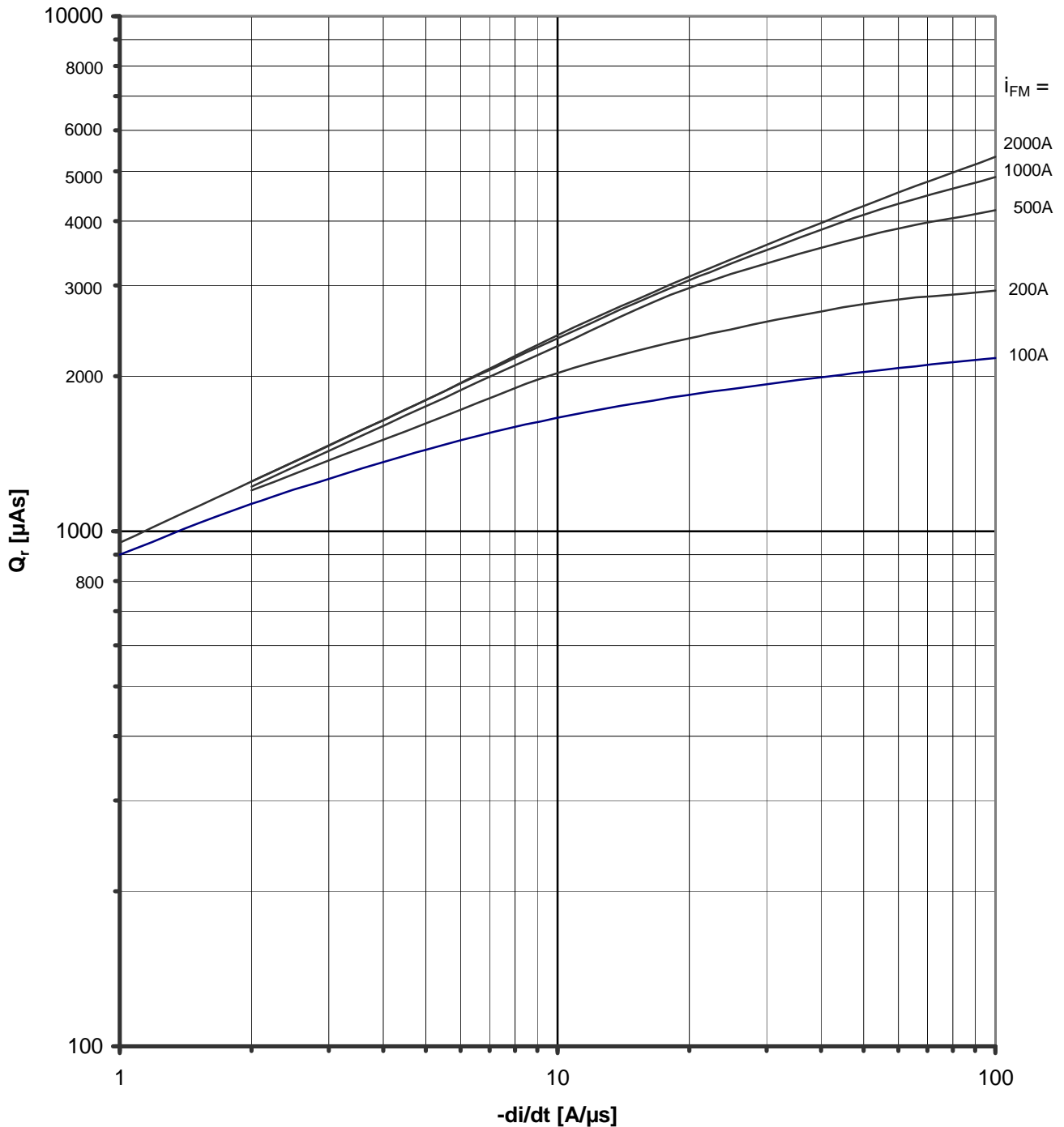

Sperrverzögerungsladung / Recovered charge $Q_r = f(-di_F/dt)$

$T_{vj} = T_{vjmax}$; $V_R = 0,5 V_{RRM}$; $V_{RM} = 0,8 V_{RRM}$

Parameter: Durchlaßstrom / Forward current i_{FM}

Richtwert für obere Streubereichsgrenze /

Upper limit of scatter range (standard value)

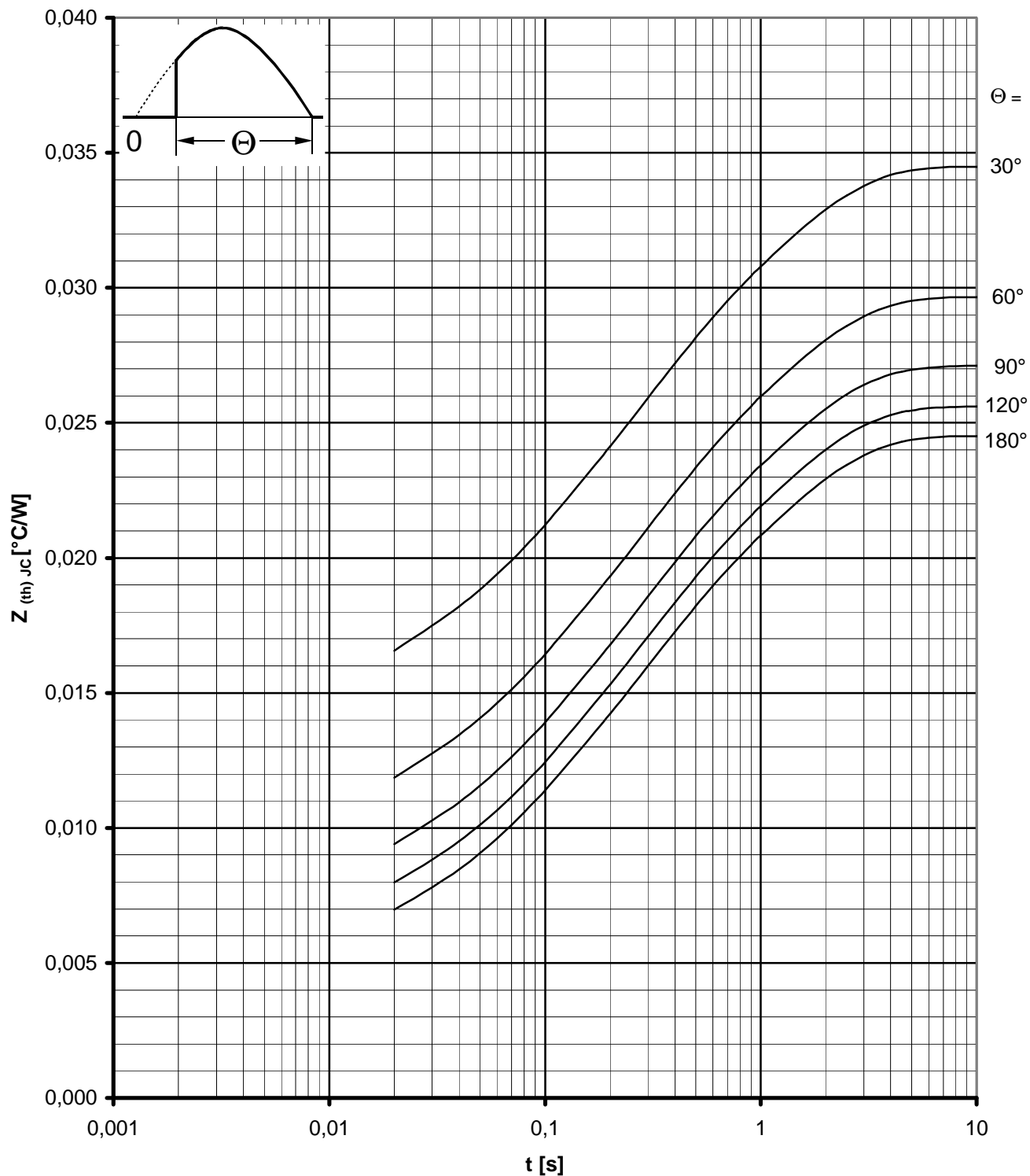

Transienter innerer Wärmewiderstand / Transient thermal impedance $Z_{(th)JC} = f(t)$
 Beidseitige Kühlung / Two-sided cooling
 Parameter: Stromflußwinkel Θ / current conduction angle Θ

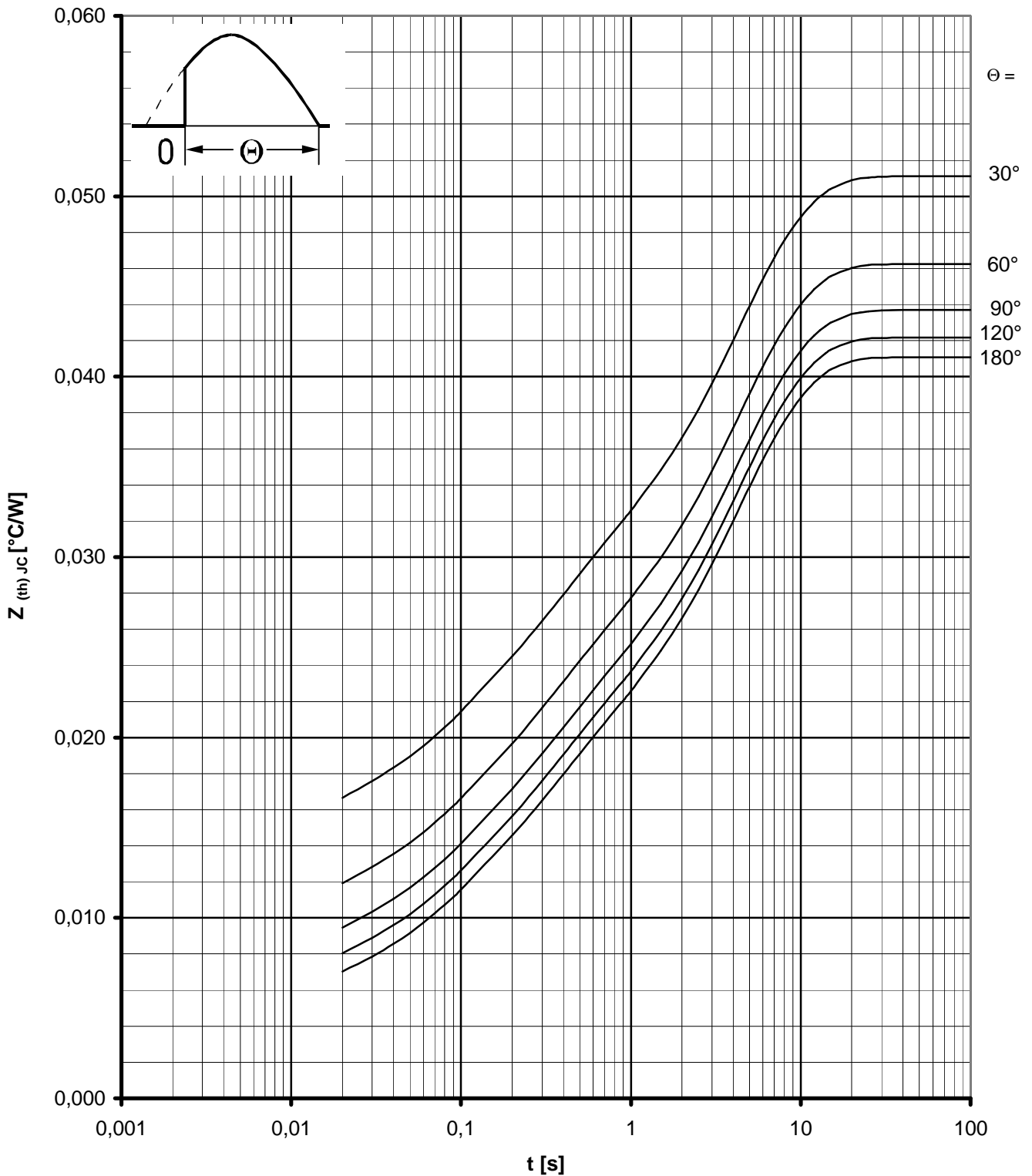

Transienter innerer Wärmewiderstand / Transient thermal impedance $Z_{(th),JC} = f(t)$

Anodenseitige Kühlung / anode side cooling

Parameter: Stromflußwinkel θ / current conduction angle θ

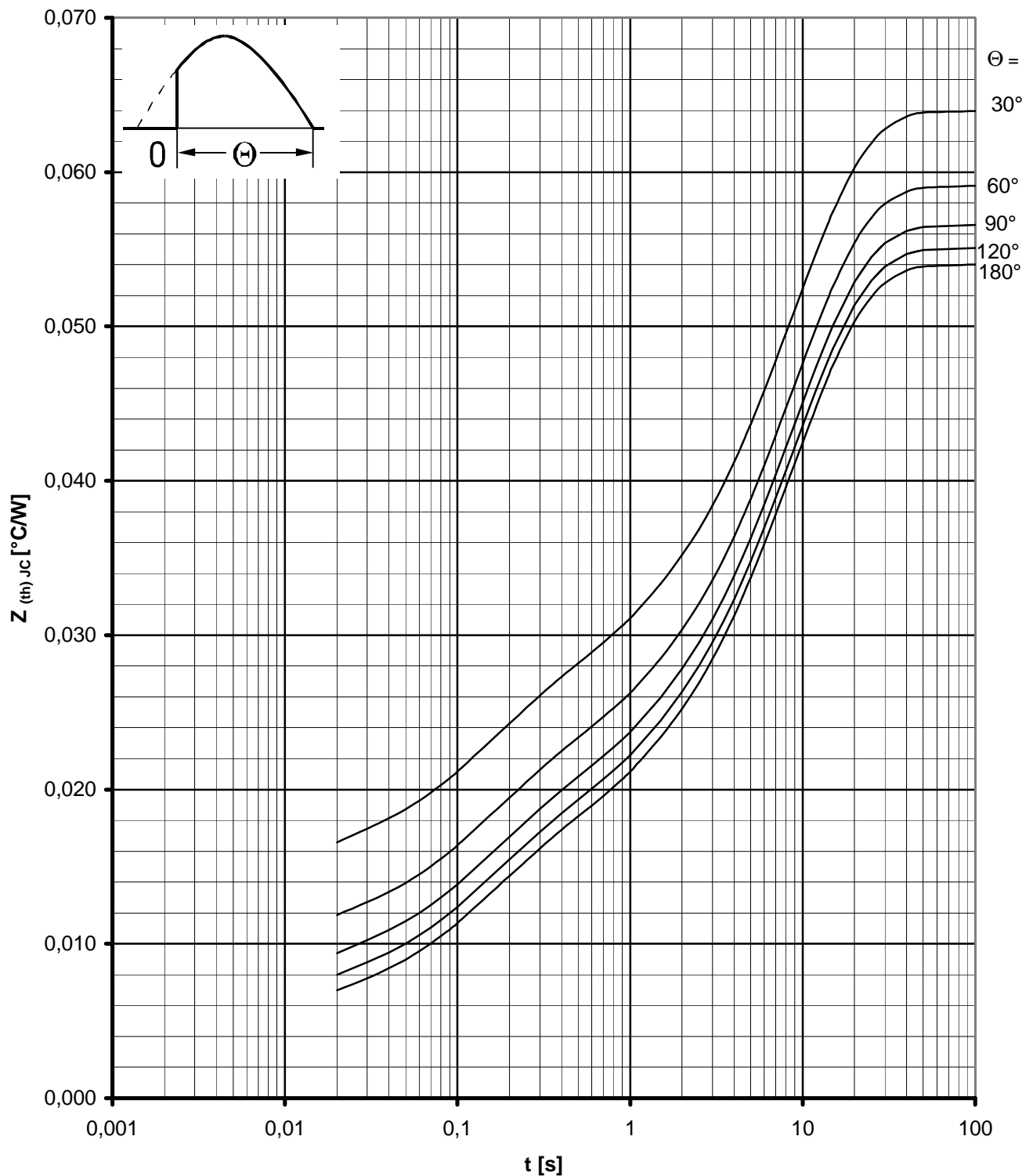

Transienter innerer Wärmewiderstand / Transient thermal impedance $Z_{(th)JC} = f(t)$
 Kathodenseitige Kühlung / Cathode-sided cooling
 Parameter: Stromflußwinkel Θ / current conduction angle Θ

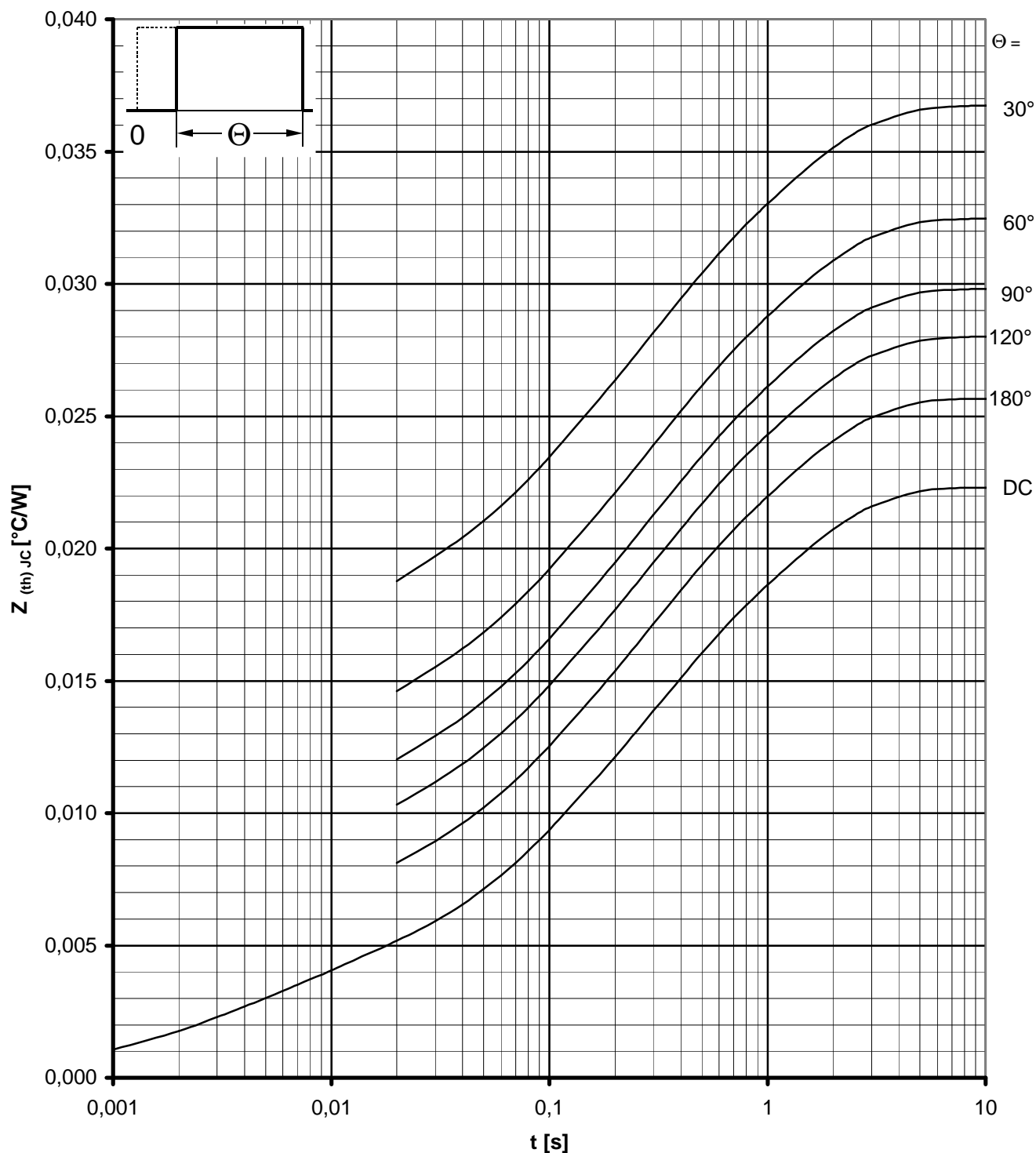

Transienter innerer Wärmewiderstand / Transient thermal impedance $Z_{(th),JC} = f(t)$

Beidseitige Kühlung / Two-sided cooling

Parameter: Stromflußwinkel Θ / current conduction angle Θ

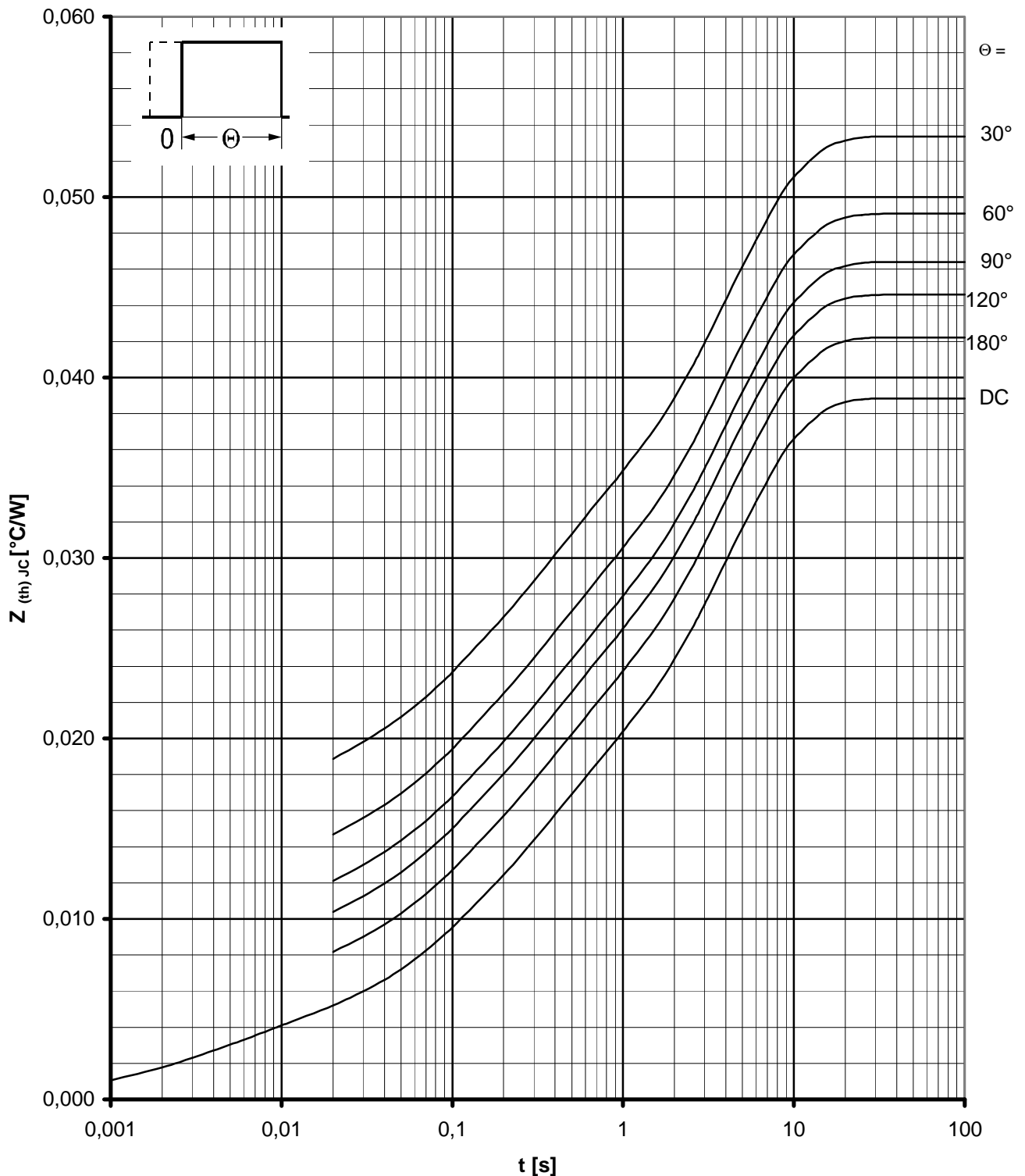

Transienter innerer Wärmewiderstand / Transient thermal impedance $Z_{(th)JC} = f(t)$

Anodenseitige Kühlung / anode side cooling

Parameter: Stromflußwinkel θ / current conduction angle θ

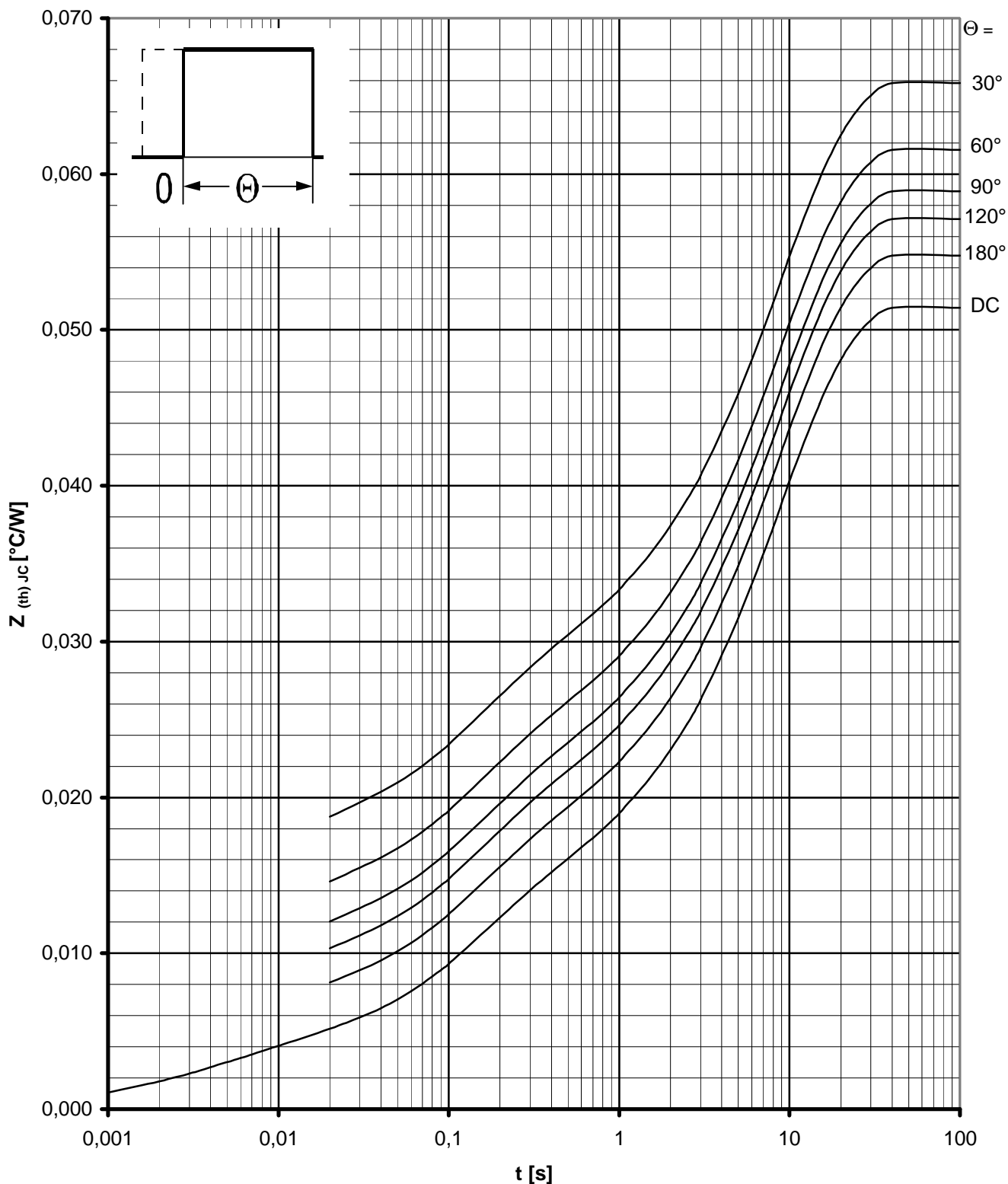

Transienter innerer Wärmewiderstand / Transient thermal impedance $Z_{(th)JC} = f(t)$
 Kathodenseitige Kühlung / Cathode-sided cooling
 Parameter: Stromflußwinkel Θ / current conduction angle Θ