

FMM5054VF

Ku Band Power Amplifier MMIC

FEATURES

- High Output Power: 32.5dBm(typ.)
- High Linear Gain: 31.0dB(typ.)
- Low Input VSWR
- Impedance Matched $Z_{in}/Z_{out} = 50\Omega$
- Small Hermetic Metal-Ceramic Package(VF-pkg)

DESCRIPTION

The FMM5054VF is a MMIC amplifier that contains a three-stage amplifier, internally matched, for standard communications in the 13.75 to 14.5GHz frequency range. This product is well suited for VSAT applications as it offers high power, high gain, and low VSWR.

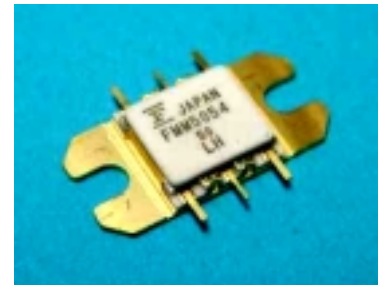

Eudyna's stringent Quality Assurance Program assures the highest reliability and consistent performance.

ABSOLUTE MAXIMUM RATING

Item	Symbol	Rating	Unit
DC Input Voltage	VDD	+10	V
DC Input Voltage	VGG	-3	V
Input Power	P _{in}	+23	dBm
Storage Temperature	T _{stg}	-55 to +125	°C

RECOMMENDED OPERATING CONDITIONS

Item	Symbol	Condition	Unit
DC Input Voltage	VDD	≤8	V
Operating Case Temperature	T _c	-40 to +85	°C

ELECTRICAL CHARACTERISTICS (Case Temperature T_c=25°C)

Item	Symbol	Condition	Limit			Unit
			Min.	Typ.	Max.	
Gate Bias Voltage	VGG(DC)		-0.01	-0.25	-0.50	V
Output Power at 1dB G.C.P.	P1dB	VDD=7V IDD=700mA(typ.) f=13.75-14.50GHz	31.5	33.0	-	dBm
Power Gain at 1dB G.C.P.	G1dB		28	31.0	-	dB
Drain Current at P1dB	IDD(RF)		-	1050	1200	mA
Power Added Efficiency at P1dB	η _{add}		-	27	-	%
Gain Flatness	ΔG		-	1.5	2.0	dB
Input Return Loss	RL _{in}	P _{in} <5dBm	-	-8	-6	dB
Output Return Loss	RL _{out}		-	-10	-6	dB
Intermodulation Distortion	IM ₃	Δf=10MHz 2-Tone Test P _{out} =22.5dBm S.C.L.	-26	-29	-	dBc

G.C.P. : Gain Compression Point, S.C.L. : Single Carrier Level

ESD	Class 0	~ 199V
-----	---------	--------

Note : Based on EIAJ ED-4701 C-111A(C=100pF, R=1.5kΩ)

CASE STYLE	VF
------------	----

FMM5054VF

Ku band Power Amplifier MMIC

OUTPUT POWER vs. FREQUENCY

VDD=7V, IDD=700mA

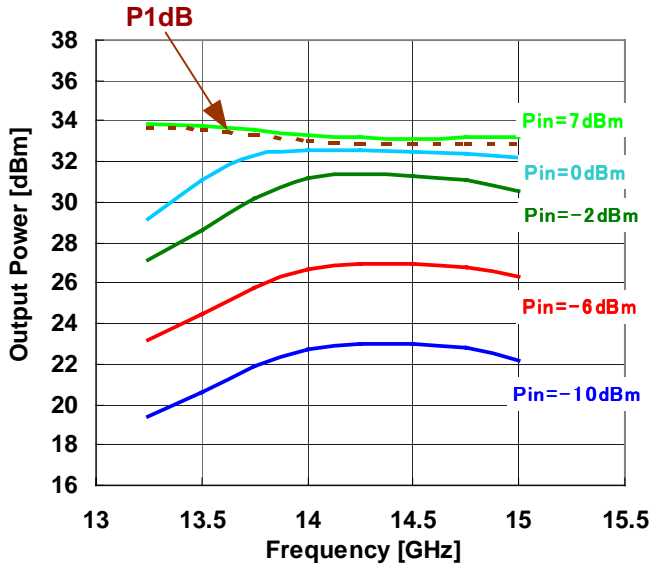

OUTPUT POWER, IDD vs. INPUT POWER

VDD=7V, IDD=700mA

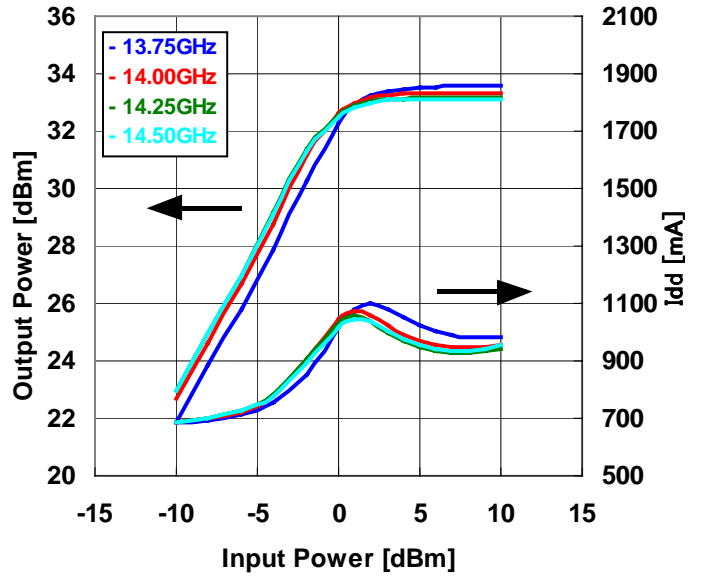

POWER ADDED EFFICIENCY vs FREQUENCY

VDD=7V, IDD=700mA

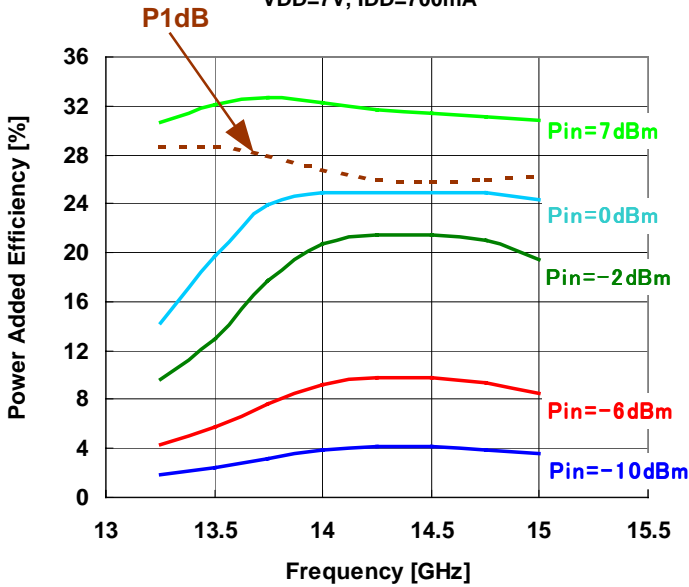

IMD vs TOTAL OUTPUT POWER

VDD=7V, IDD=700mA, Δf=+10MHz

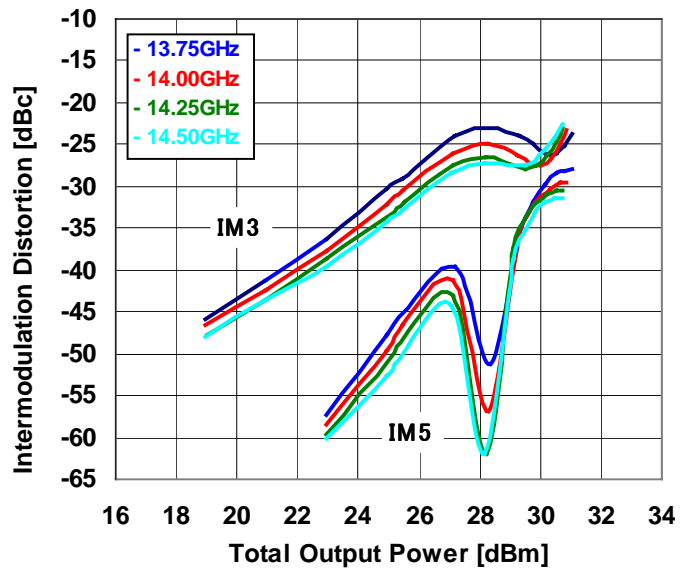

FMM5054VF

Ku band Power Amplifier MMIC

OUTPUT POWER, DRAIN CURRENT vs. INPUT POWER by Drain Voltage

IDD=700mA @ 13.75GHz

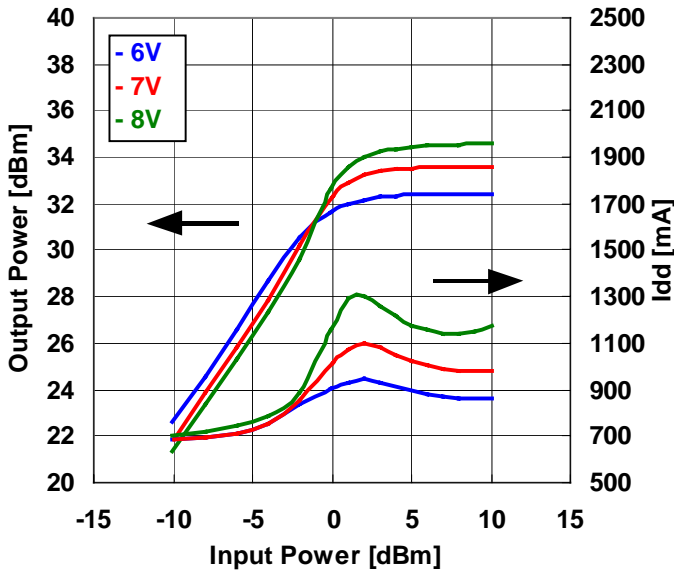

IDD=700mA @ 14.00GHz

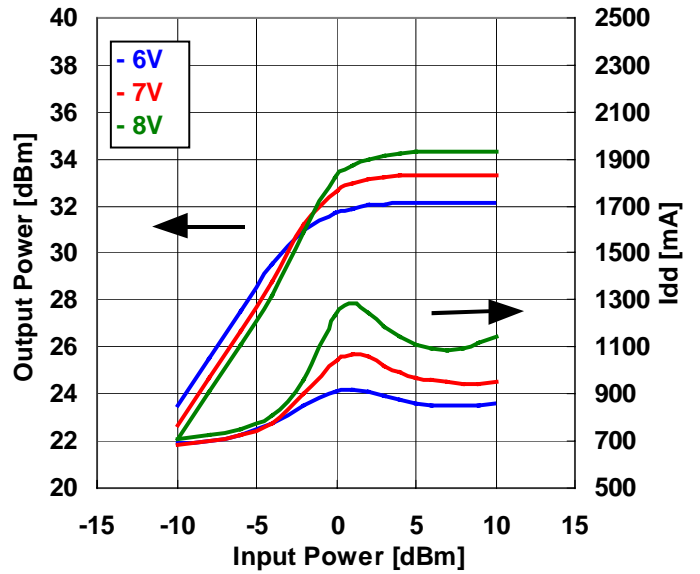

IDD=700mA @ 14.25GHz

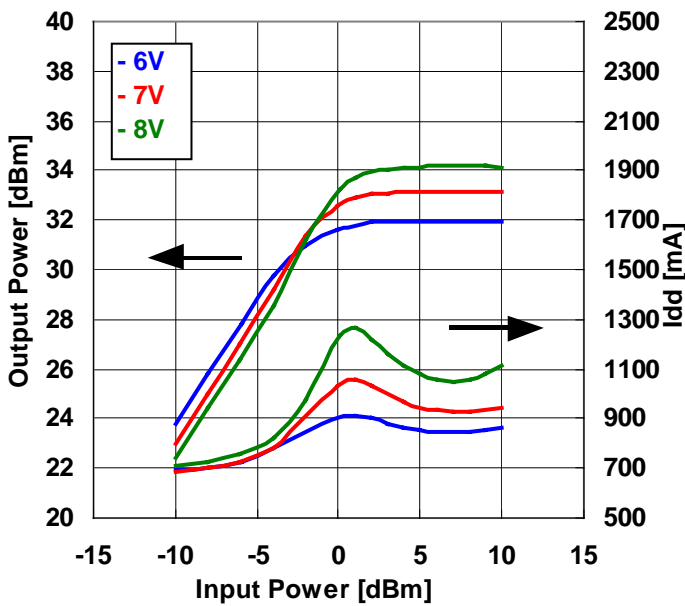

IDD=700mA @ 14.50GHz

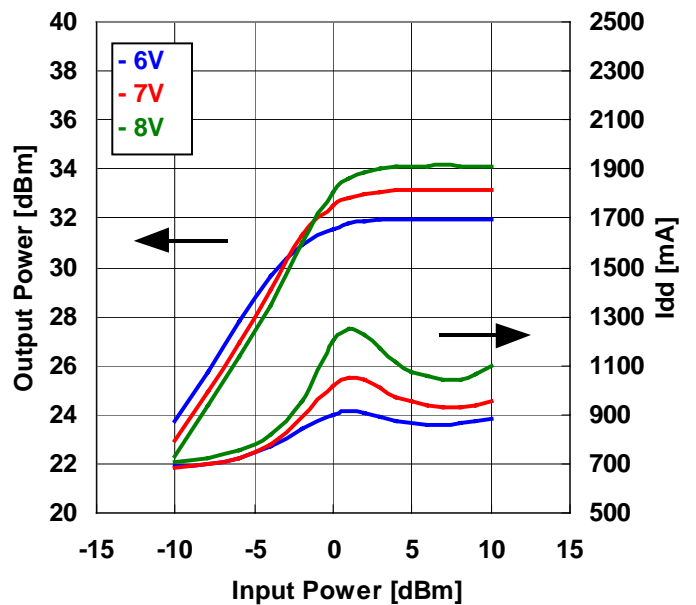

FMM5054VF

Ku band Power Amplifier MMIC

OUTPUT POWER, DRAIN CURRENT vs. INPUT POWER by Drain Current

VDD=7V @ 13.75GHz

VDD=7V @ 14.00GHz

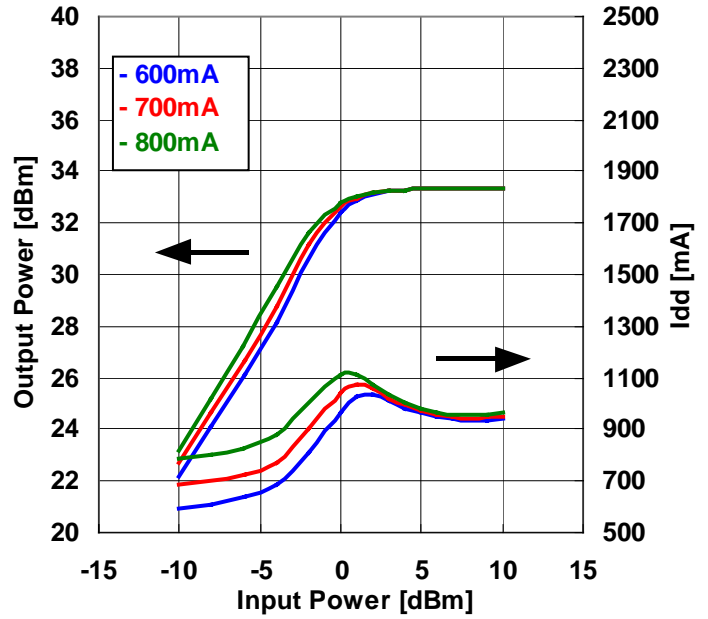
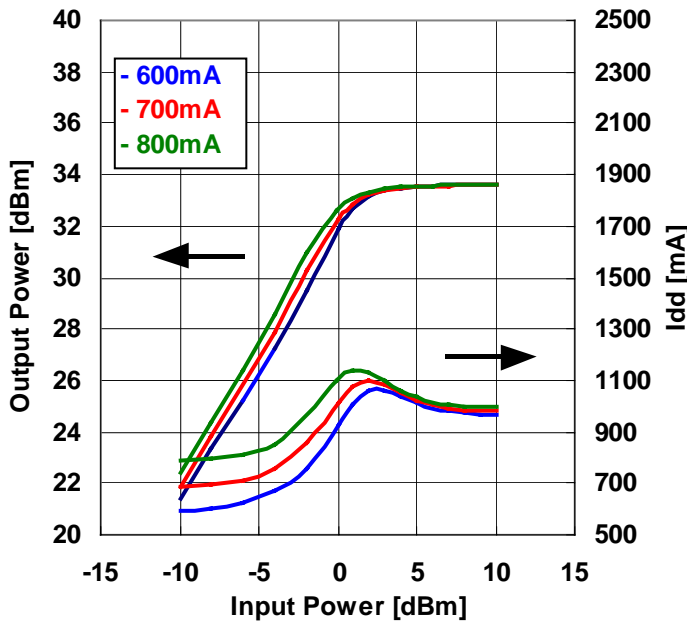

VDD=7V @ 14.25GHz

VDD=7V @ 14.50GHz

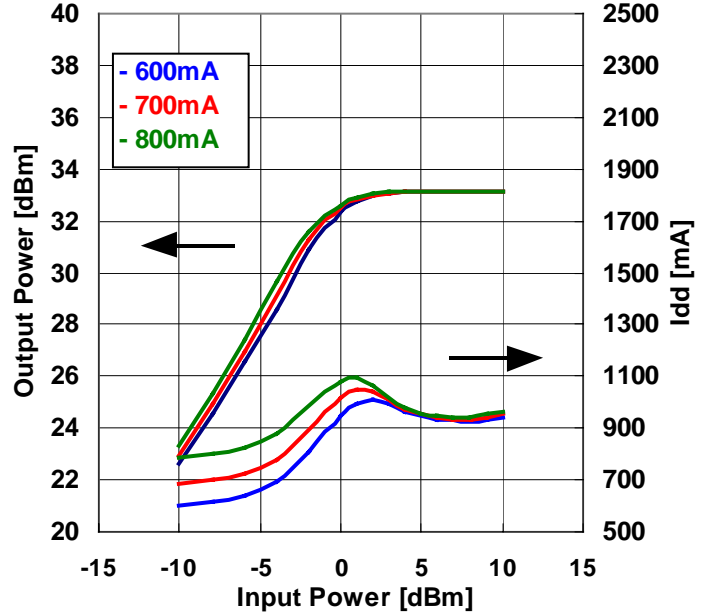
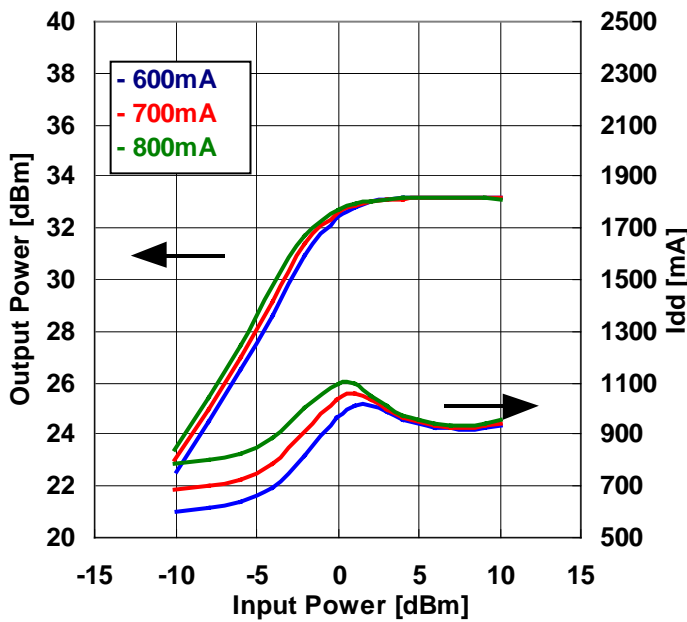

FMM5054VF

Ku band Power Amplifier MMIC

IMD PERFORMANCE vs OUTPUT POWER by Drain Voltage

IDD=700mA, $\Delta f=+10\text{MHz}$ @ 13.75GHz

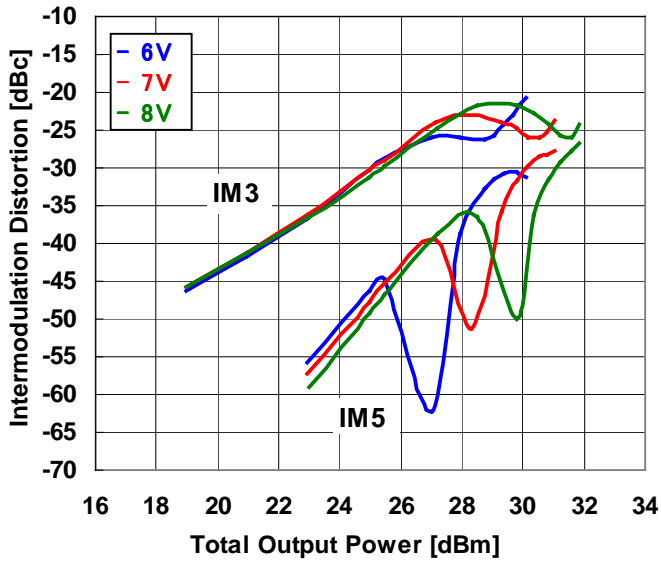

IDD=700mA, $\Delta f=+10\text{MHz}$ @ 14.00GHz

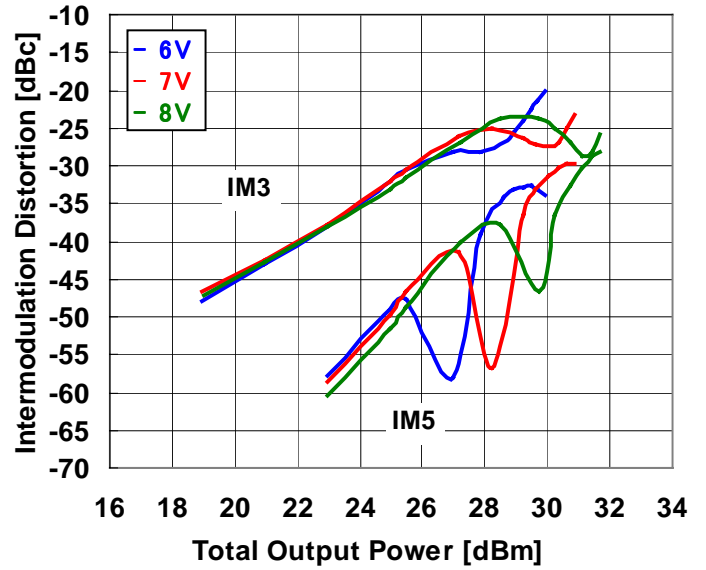

IDD=700mA, $\Delta f=+10\text{MHz}$ @ 14.25GHz

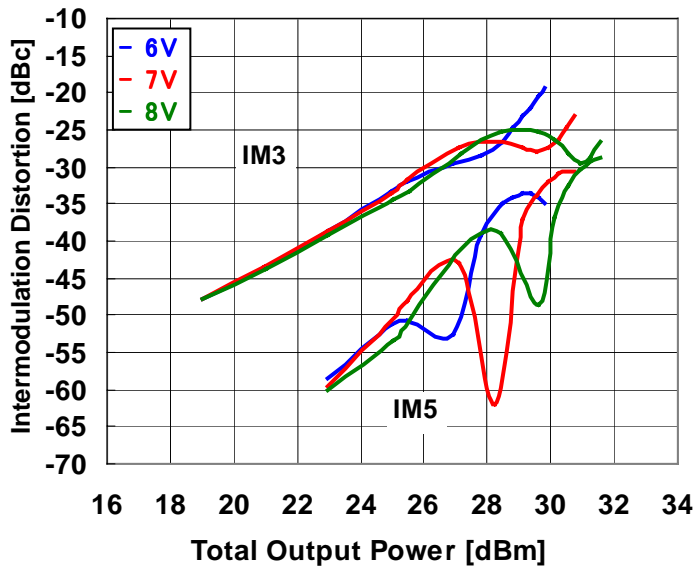

IDD=700mA, $\Delta f=+10\text{MHz}$ @ 14.50GHz

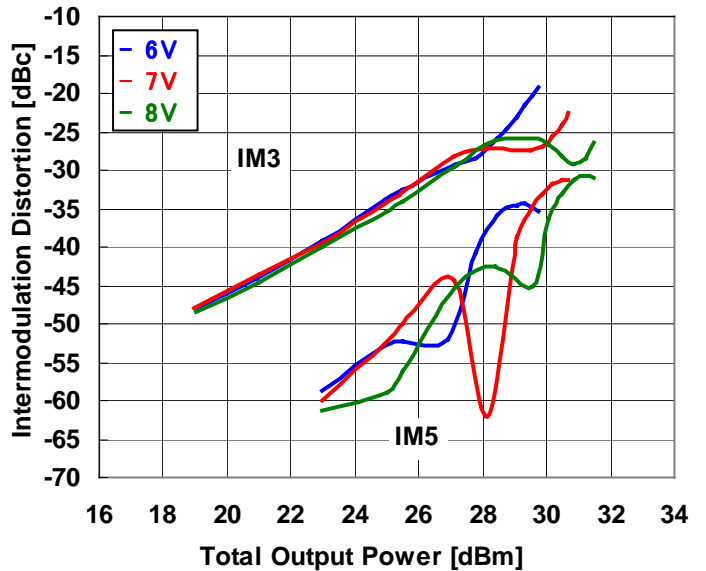

FMM5054VF

Ku band Power Amplifier MMIC

OUTPUT POWER, DRAIN CURRENT vs. TOTAL INPUT POWER by Drain Current

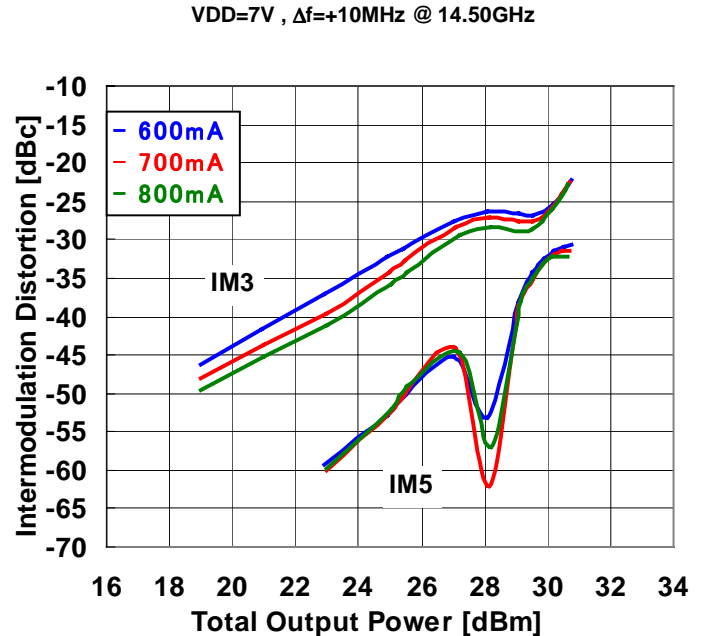
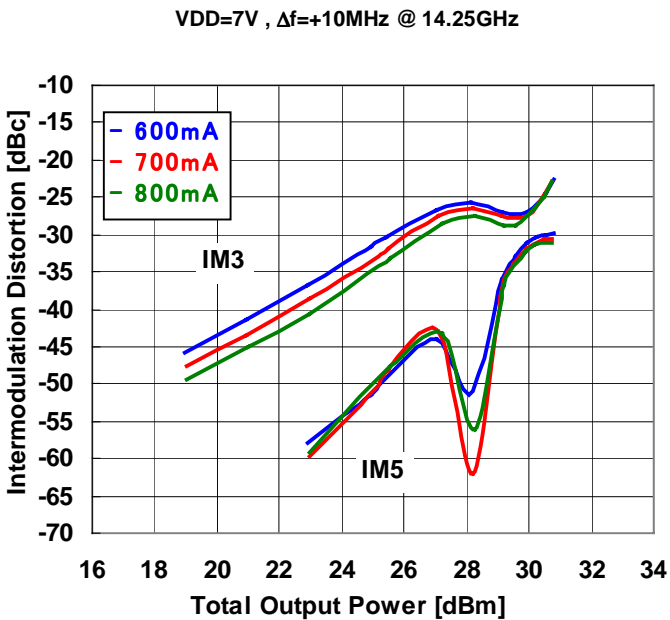
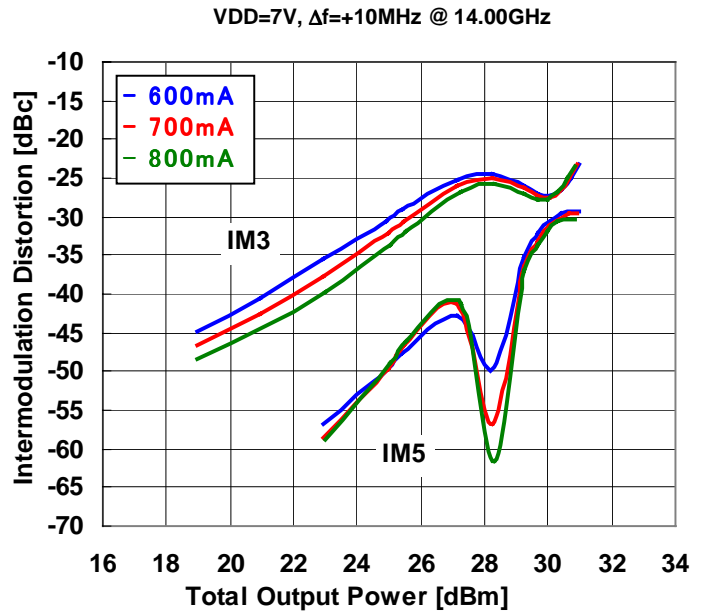
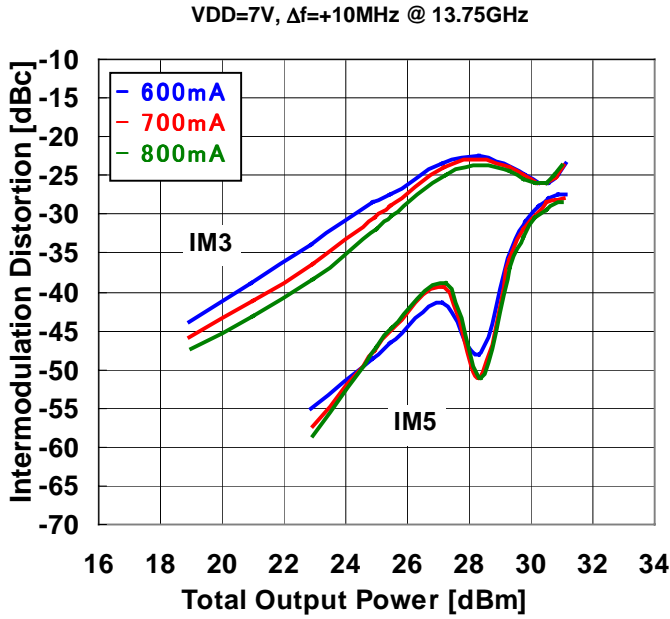

FMM5054VF

Ku Band Power Amplifier MMIC

OUTPUT POWER , DRAIN CURRENT vs. INPUT POWER by Temperature

VDD=7V, IDD=700mA @ 13.75GHz

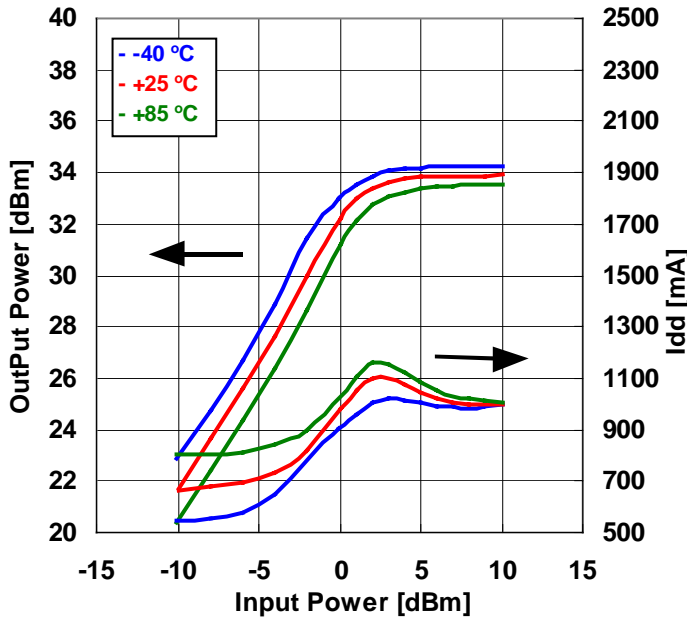

VDD=7V, IDD=700mA @ 14.00GHz

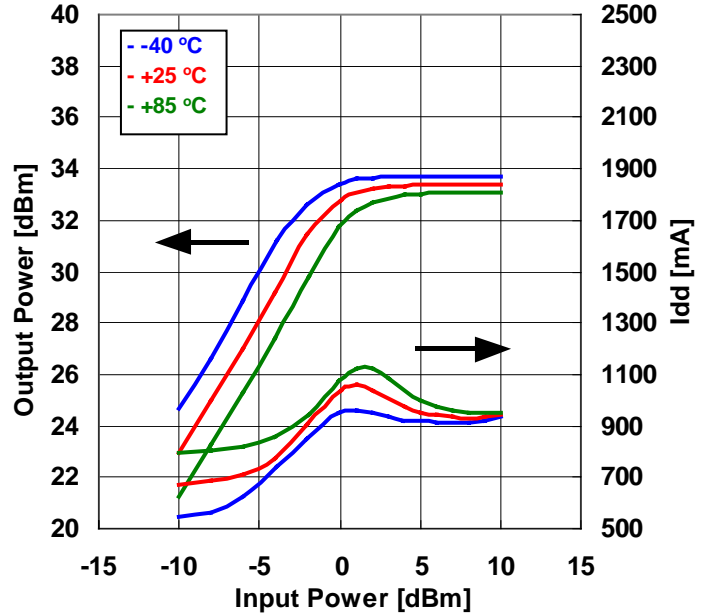

VDD=7V, IDD=700mA @ 14.25GHz

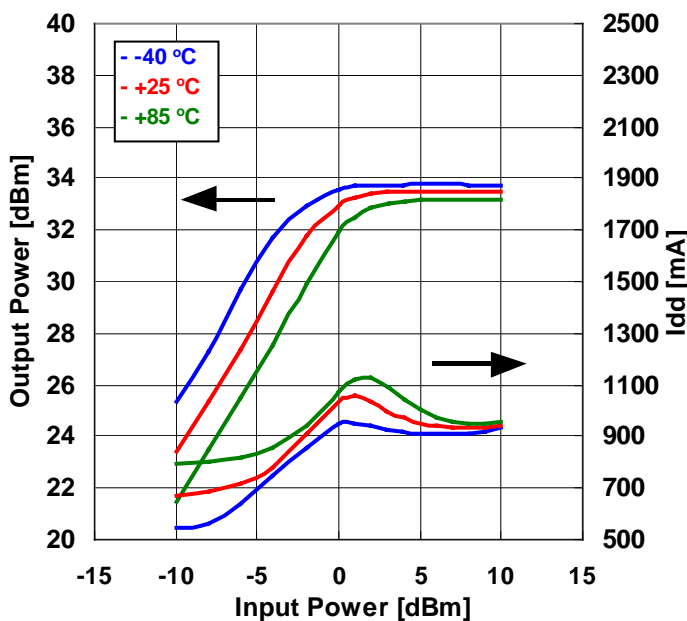

VDD=7V, IDD=700mA @ 14.50GHz

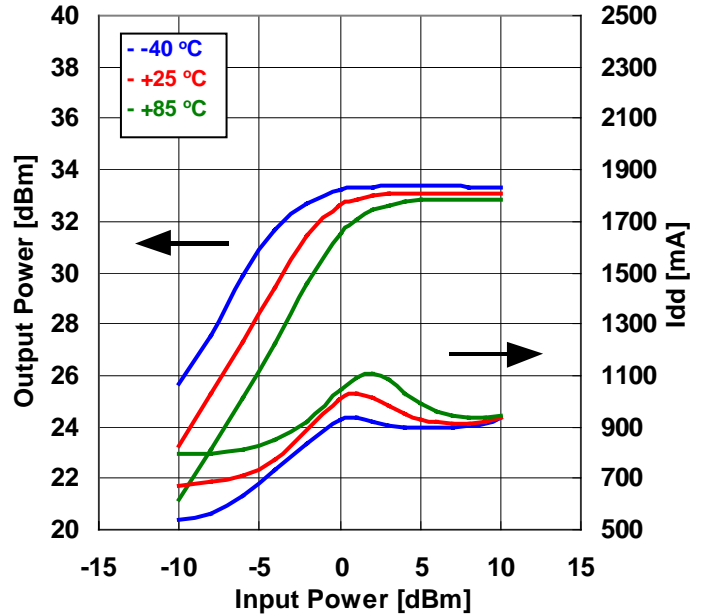

FMM5054VF

Ku band Power Amplifier MMIC

IMD PERFORMANCE vs. TOTAL OUTPUT POWER by Temperature

VDD=7V, IDD=700mA, $\Delta f=+10\text{MHz}$ @ 13.75GHz

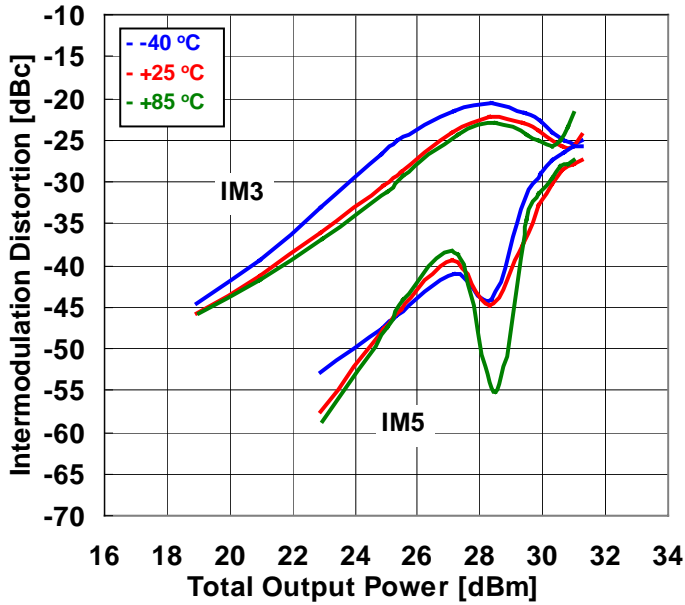

VDD=7V, IDD=700mA, $\Delta f=+10\text{MHz}$ @ 14.00GHz

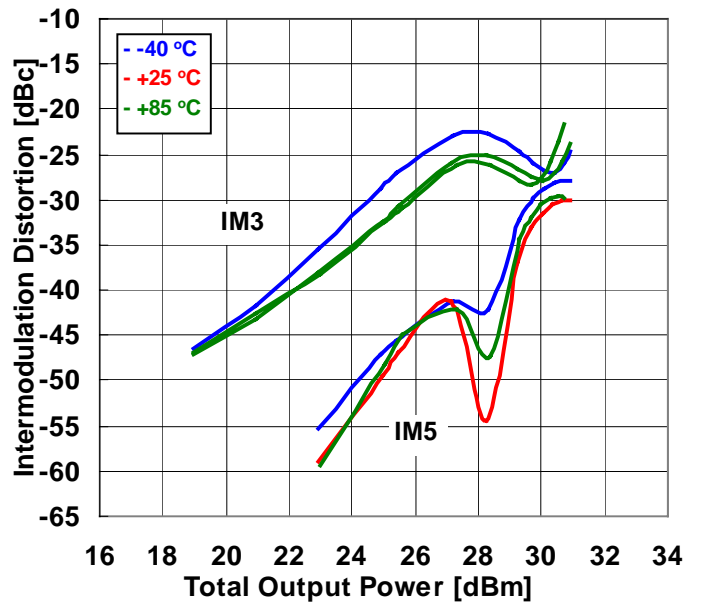

VDD=7V, IDD=700mA, $\Delta f=+10\text{MHz}$ @ 14.25GHz

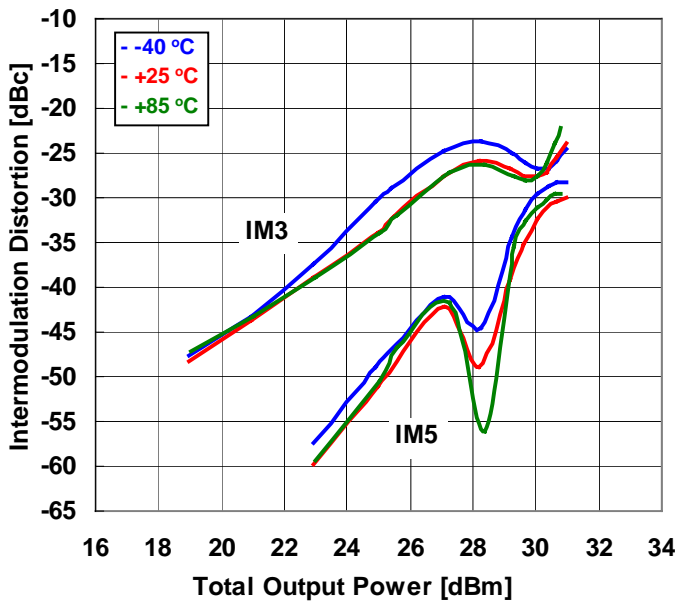

VDD=7V, IDD=700mA, $\Delta f=+10\text{MHz}$ @ 14.50GHz

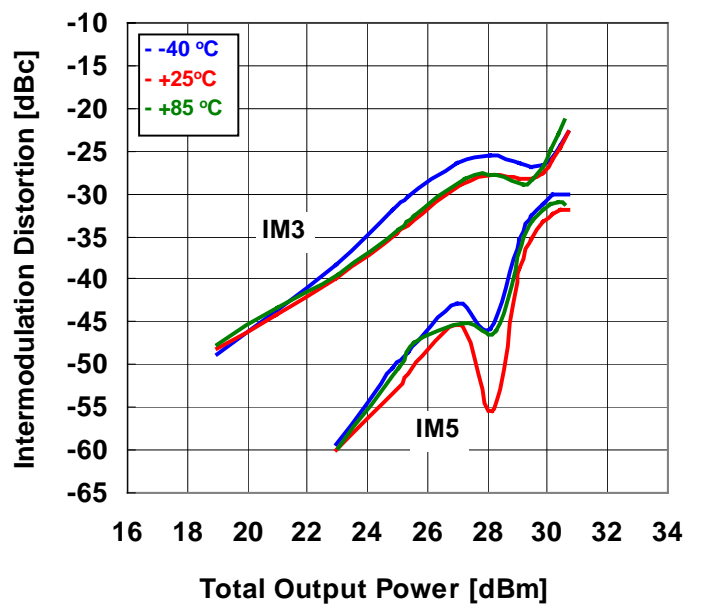

FMM5054VF

Ku Band Power Amplifier MMIC

P1dB and G1dB vs. TEMPERATURE

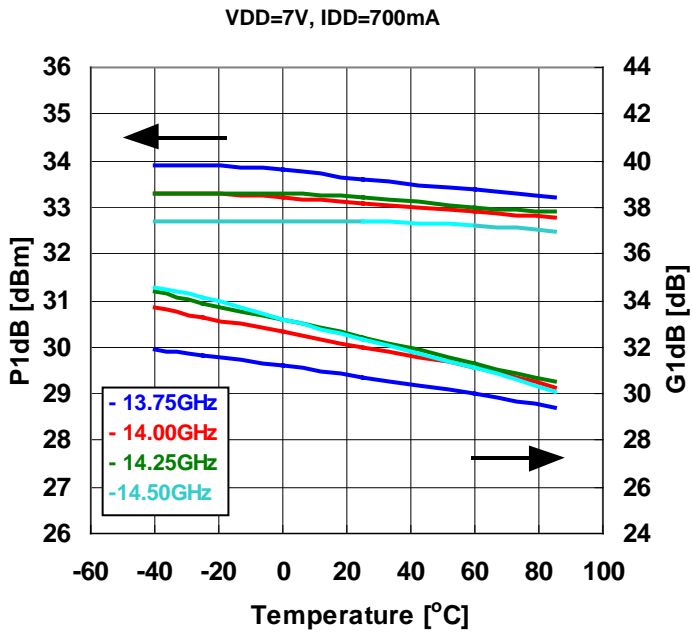

IMD PERFORMANCE vs. TEMPERATURE

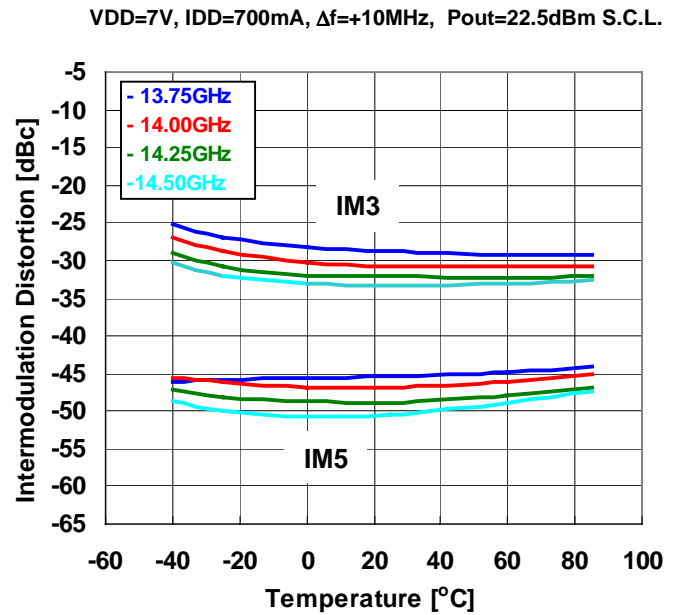

P1dB and G1dB vs. Drain Voltage

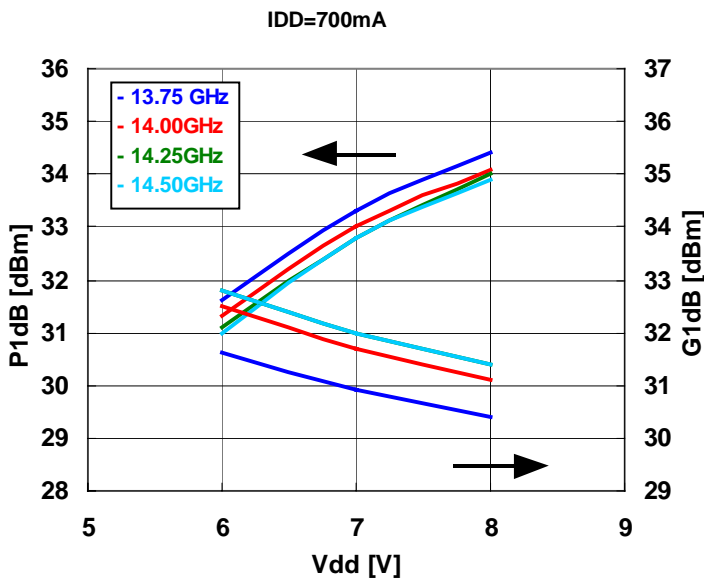

INTERMODULATION DISTORTION vs. Drain Voltage

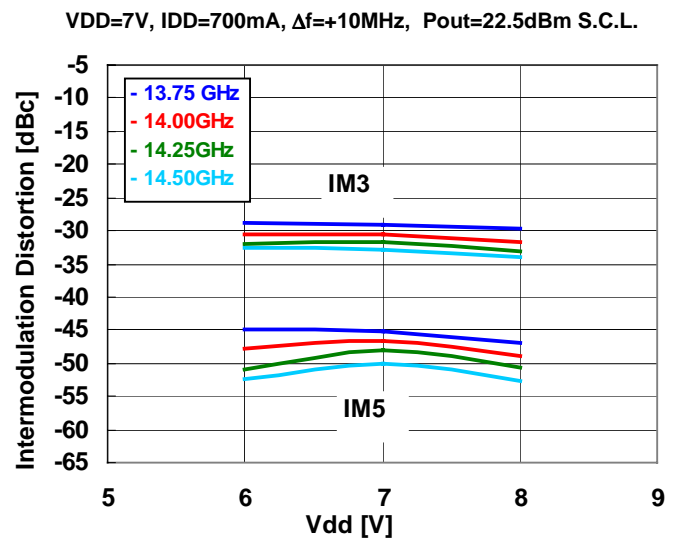

FMM5054VF

Ku band Power Amplifier MMIC

■ S-PARAMETER

INPUT/OUTPUT RETURN LOSS vs. FREQUENCY

Vdd=7V, Idd=700mA, Pin=-20 dBm

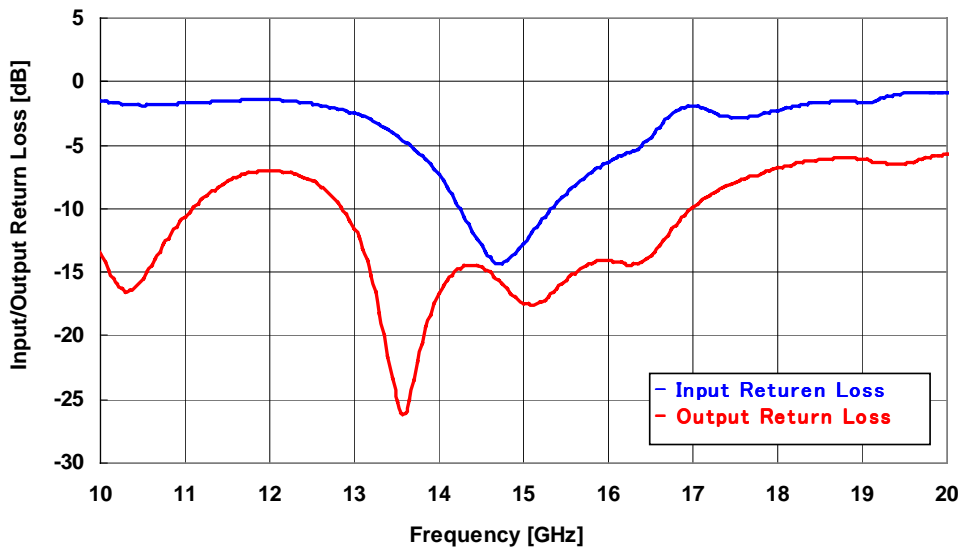

SMALL SIGNAL GAIN vs. FREQUENCY

Vdd=7V, Idd=700mA, Pin=-20dBm

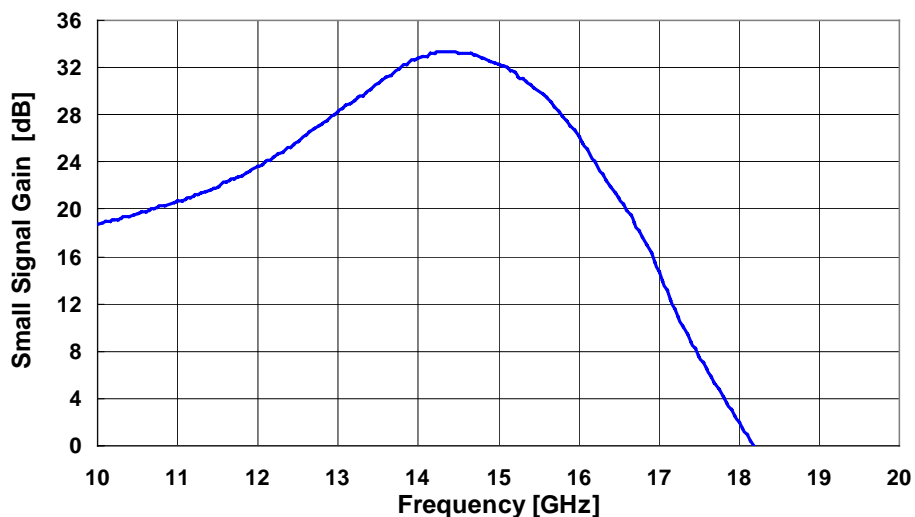

FMM5054VF

Ku Band Power Amplifier MMIC

■ S-PARAMETER

VDD=7.0V , IDD=700mA

FREQUENCY [GHz]	S11		S21		S12		S22	
	MAG	ANG	MAG	ANG	MAG	ANG	MAG	ANG
1.00	0.975	-38.22	0.038	63.46	0.000	156.33	0.984	-43.45
2.00	0.943	-74.83	0.137	-143.34	0.000	-179.17	0.927	-83.40
3.00	0.947	-107.31	0.161	130.88	0.001	166.68	0.921	-119.80
4.00	0.943	-140.26	0.200	72.38	0.002	138.71	0.941	-158.75
5.00	0.909	179.82	0.268	31.27	0.003	97.79	0.906	155.92
6.00	0.908	136.71	0.642	-20.63	0.002	42.50	0.858	107.98
7.00	0.898	97.45	1.486	-88.46	0.001	-12.07	0.829	59.51
8.00	0.866	61.17	3.724	-179.79	0.001	-70.19	0.751	8.12
9.00	0.868	23.30	6.172	78.33	0.003	-121.82	0.569	-56.01
10.00	0.836	-15.02	8.659	-22.90	0.004	-174.73	0.211	-161.38
11.00	0.822	-45.49	10.787	-117.42	0.004	170.05	0.295	25.53
12.00	0.847	-79.94	15.153	151.05	0.004	117.17	0.446	-44.33
13.00	0.750	-122.22	26.134	47.66	0.003	72.45	0.265	-105.75
13.25	0.692	-136.29	29.656	17.71	0.002	58.72	0.148	-117.71
13.50	0.613	-151.02	34.131	-13.40	0.001	75.67	0.055	-90.74
13.75	0.527	-169.63	39.225	-47.33	0.001	100.29	0.079	-21.92
13.80	0.510	-173.81	40.373	-54.56	0.001	106.32	0.093	-20.13
13.85	0.492	-178.33	41.209	-61.97	0.001	106.45	0.108	-19.07
13.90	0.472	176.61	42.211	-69.25	0.001	106.53	0.121	-18.65
13.95	0.451	171.96	42.930	-77.00	0.001	106.63	0.135	-19.45
14.00	0.430	167.01	43.508	-84.57	0.002	107.85	0.147	-20.48
14.05	0.406	161.56	44.163	-92.17	0.002	106.96	0.158	-22.67
14.10	0.385	155.97	44.688	-99.77	0.002	104.97	0.166	-25.03
14.15	0.359	149.82	45.422	-107.50	0.002	104.06	0.173	-27.50
14.20	0.335	143.36	45.852	-115.33	0.002	103.48	0.180	-29.29
14.25	0.314	136.37	46.124	-123.41	0.002	102.07	0.185	-31.90
14.30	0.295	128.51	46.295	-131.17	0.002	100.19	0.189	-34.69
14.35	0.274	120.54	46.277	-139.28	0.002	99.46	0.191	-37.05
14.40	0.256	112.13	46.350	-147.10	0.002	95.72	0.190	-39.48
14.45	0.241	103.30	46.324	-154.99	0.002	95.23	0.188	-41.80
14.50	0.225	93.34	46.088	-162.95	0.003	91.58	0.187	-43.78
14.75	0.192	37.13	44.501	157.47	0.003	81.21	0.160	-49.18
15.00	0.231	-12.69	41.203	117.96	0.003	70.59	0.134	-44.00
16.00	0.482	-119.38	20.434	-40.56	0.006	47.36	0.197	-64.57
17.00	0.799	-177.08	5.447	-178.54	0.015	-45.48	0.319	-165.84
18.00	0.771	157.57	1.261	89.72	0.005	-108.89	0.457	117.63
19.00	0.829	142.49	0.378	8.09	0.011	-141.25	0.498	69.33
20.00	0.899	127.55	0.126	-78.58	0.010	148.92	0.516	7.48

FMM5054VF

Ku band Power Amplifier MMIC

ΔT_{ch} vs. DRAIN VOLTAGE (Reference Data)

$I_{DD}=700mA$

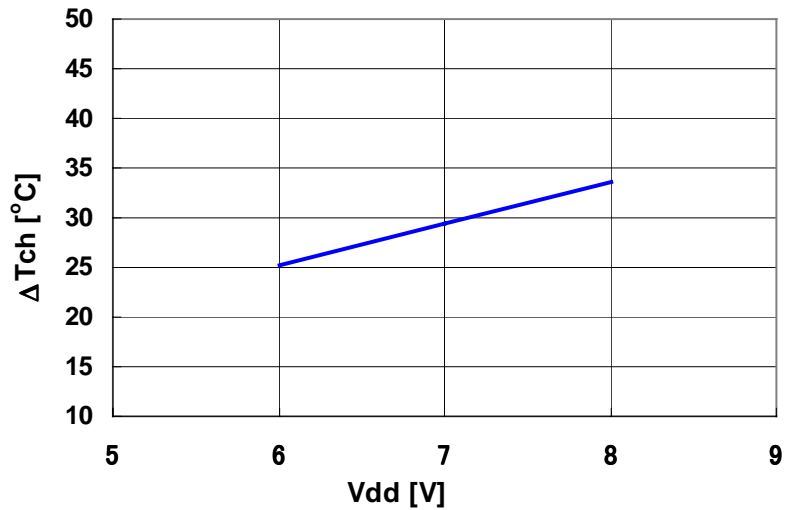

MTTF vs. T_{ch}

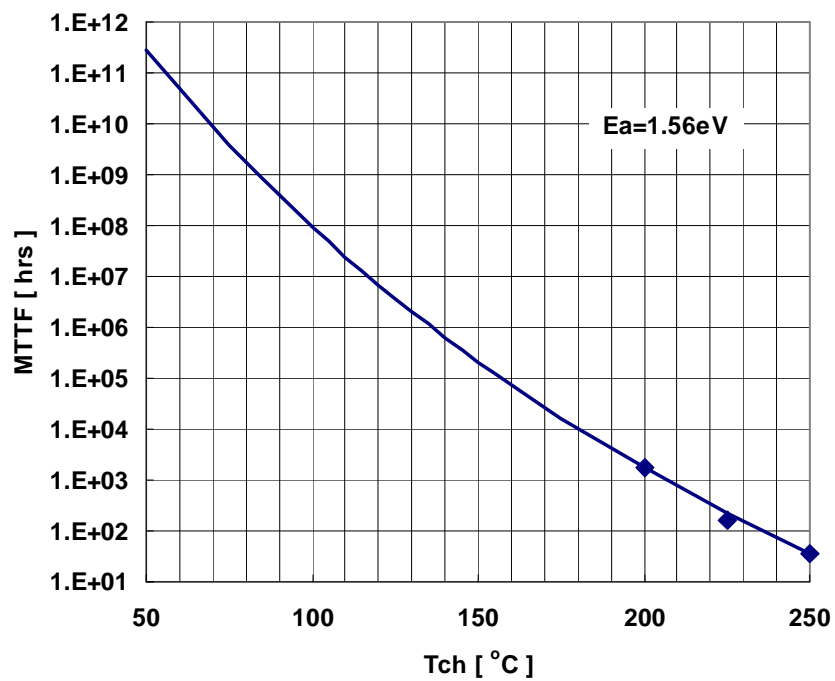



FMM5054VF

Ku Band Power Amplifier MMIC

■ Package Outline

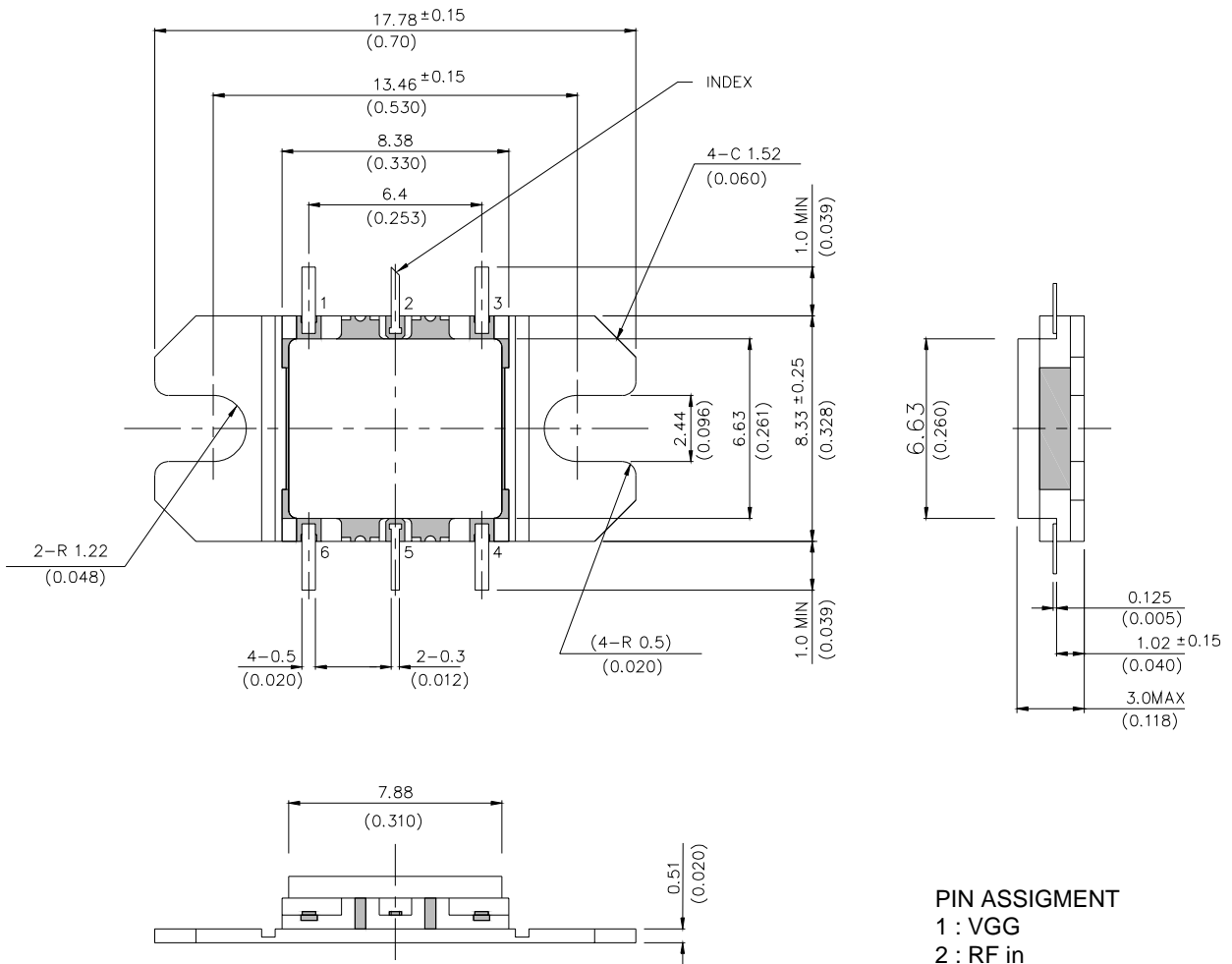

FMM5054VF

Ku band Power Amplifier MMIC

■ Mounting Instructions for VF Package

1. Screw Mounting

- (1) The flange of package may be attached using screws. Torque conditions are shown in table 1.

Table 1. Recommended and Maximum Torque for Screw Mounting

Package	Recommended screw	Recommended Torque	Maximum Torque
VF	M2.0	10 N-cm (0.9 lb-in)	15 N-cm (1.3 lb-in)

- (2) First, tighten the screws with a torque driver set to 5 N-cm.
- (3) The surface finish of the heat sink should be better than 0.8 μm , and the surface flatness must be better than 10 μm .
- (4) Silicon based heat sink compounds should not be used for the thermal conductive grease. They cause poor grounding of the source flange, contamination and long term degradation of thermal resistance between the FET package and heat sink.

2. Solder Mounting

- (1) Recommended solder are Tin-Lead solder (63Sn/37Pb), Lead-Free solder (Sn-3.0Ag-0.5Cu)*¹ or equivalent.
- (2) For soldering, Tin-Lead solder (63Sn/37Pb) or Lead-Free solder (Sn-3.0Ag-0.5Cu)*¹ shall be used. (*1: The figure displays with weight %. A predominantly tin-rich alloy with 3.0% silver and 0.5% copper.)
- (3) Recommended Flux is Rosin type with chlorine content: 0.2% or less and a low halogen content. After soldering, the flux residue should be removed by appropriate cleaning methods.
- (4) The recommended soldering conditions are as follows:

Partial heating method (soldering iron, spot laser/air)

Product terminal temperature: 260 deg-C, max. 10 s./terminal or

400 deg-C, max. 3 s./terminal

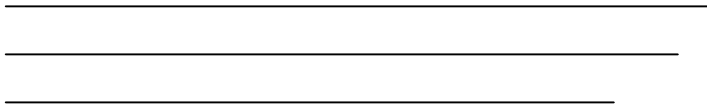

FMM5054VF

Ku Band Power Amplifier MMIC

Recommended Bias Circuit and Internal Block Diagram

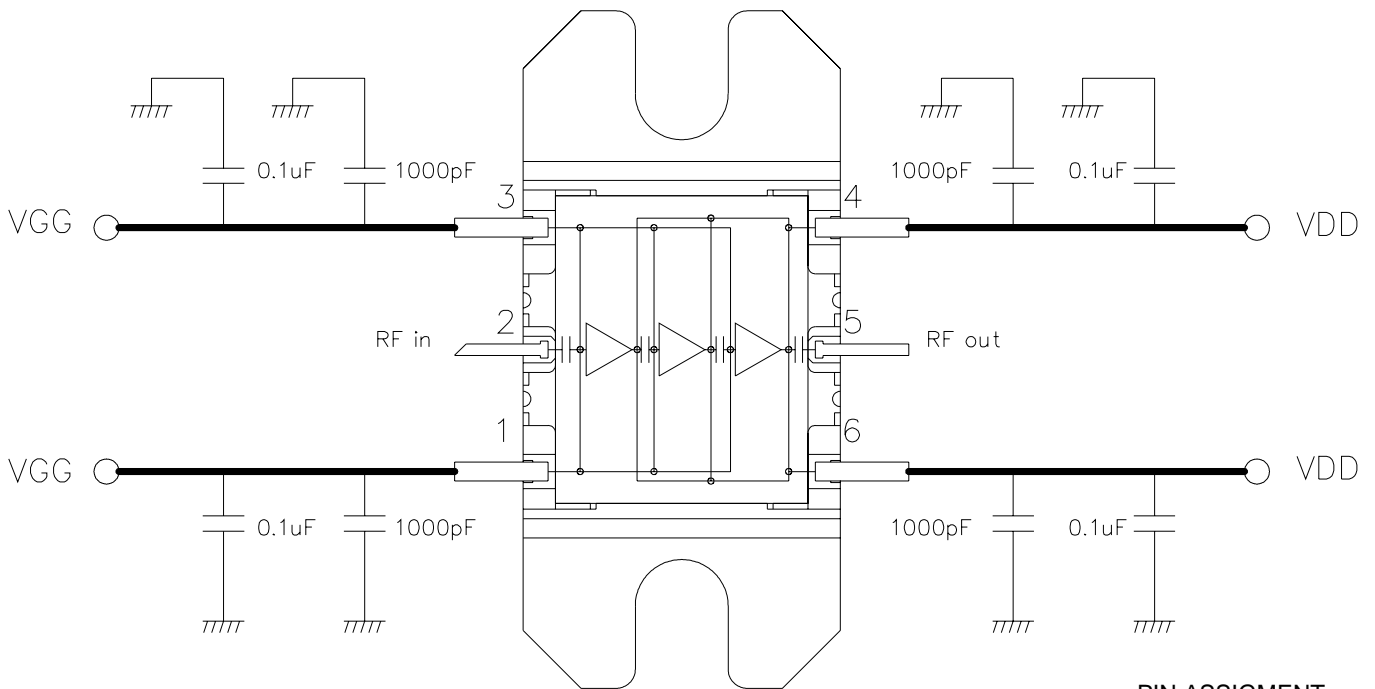

- PIN ASSIGNMENT**
- 1 : VGG
 - 2 : RF in
 - 3 : VGG
 - 4 : VDD
 - 5 : RF out
 - 6 : VDD

Note 1: The capacitors are recommended on the bias supply line, close to the package, in order to prevent video oscillations which could damage the module.

Note 2: Two pins both VGG and VDD are internally connected respectively.

FMM5054VF

Ku band Power Amplifier MMIC

EUDYNA DEVICES USA INC.

2355 Zanker Road
San Jose, CA 95131
Phone: +408-232-9500
FAX: +408-428-9111

EUDYNA DEVICES EUROPE LTD.

Norreys Drive
Maidenhead Berkshire, SL6 4FJ United Kingdom
Phone: +44-1628-504800
FAX: +44-1628-504888

EUDYNA DEVICES ASIA PTE. LTD. HONG KONG BRANCH

Rm. 1101, Ocean Centre, 5 Canton Road, Tsim Sha Tsui, Kowloon,
Honk Kong
Tel: +852-2377-0227
Fax: +852-2377-3921

EUDYNA DEVICES INC.

JAPANESE SALES OFFICE(Head Office)

1, Kanai-cho, Sakae-ku, Yokohama,
244-0845, Japan
Tel: +81-45-853-8150
Fax: +81-45-853-8170
www.eudyna.com

CAUTION

Eudyna Devices Compound Semiconductor Products contain **gallium arsenide (GaAs)** which can be hazardous to the human body and the environment.

For safety, observe the following procedures:

- Do not put these products into the mouth.
- Do not alter the form of this product into a gas, powder, or liquid through burning, crushing, or chemical processing as these by-products are dangerous to the human body if inhaled, ingested, or swallowed.
- Observe government laws and company regulations when discarding this product. This product must be discarded in accordance with methods specified by applicable hazardous waste procedures.

Eudyna Devices Incorporated reserves the right to change products and specifications without notice.
The information does not convey any license under rights of Eudyna Devices Incorporated or others.

Eudyna