



# SME1400B-13

Broadband Surface Mount Mixer

The Communications Edge™

## Product Features

- RF 1 to 2200 MHz
- LO 1 to 2200 MHz
- IF 1 to 2000 MHz
- LO Drive: +13 dBm (Other Levels Available)
- No Internal Solder Connections

## Product Photo



## Specifications

Parameter	Units	Typical	Guaranteed	
			+25°C	-40° to +85°C
SSB Conversion Loss (Max)				
RF/LO = 10-1300 MHz, IF = 10-1000 MHz	dB	6.5	8.0	8.5
RF/LO = 10-2500 MHz, IF = 30-1000 MHz	dB	7.5	9.0	9.5
RF/LO = 1-2200 MHz, IF = 1-2000 MHz	dB	8.0		
Port-to-Port Isolation (Min)				
L-R = 10-2000 MHz	dB	30		21
L-R = 10-2500 MHz	dB	25		17
L-I = 10-2000 MHz	dB	26		20
L-I = 10-2500 MHz	dB	22		16
R-I = 10-2200 MHz	dB	25		
3rd Order Input Intercept Point	dBm	22		
VSWR				
R-Port = 600-2000 MHz		1.7:1		
R-Port = 10-2500 MHz		2.0:1		
L-Port = 600-2000 MHz		1.6:1		
L-Port = 10-2500 MHz		2.0:1		
I-Port		1.8:1		
1 dB Conversion Compression	dBm	+9		

1. Measured in a 50-ohm system with nominal LO drive of +13 dBm, low side LO, and downconverter application only, unless otherwise specified.

2. Measured at RF = 820 MHz, LO = 750 MHz, IF = 70 MHz, unless otherwise specified.

## Absolute Maximum Ratings

Parameter	Rating
Operating Temperature	-40 to +85°C
Storage Temperature	-65 to +100°C
Combined RF and LO Input Power	+19 dBm

## Ordering Information

Part No.	Description
SME1400B-13	Mixer (Available in tape and reel)
SME1400B-13-PCB	Fully Assembled Application Circuit

## Performance Charts

### Conversion Loss vs. Frequency

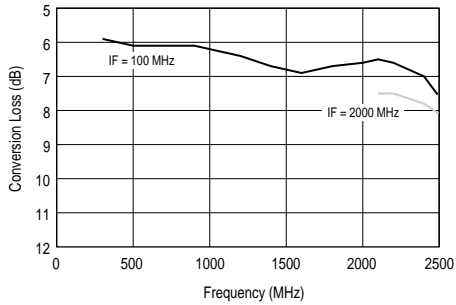

### Conversion Loss vs. RF Power

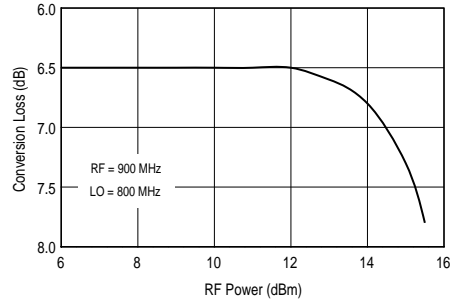

### Conversion Loss vs. LO Power

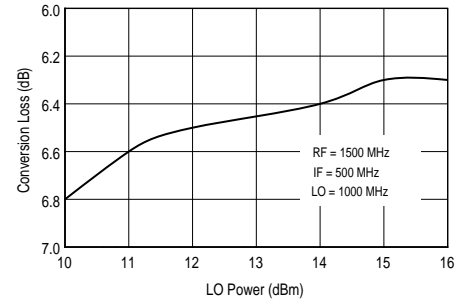

### Conversion Loss vs. Temperature

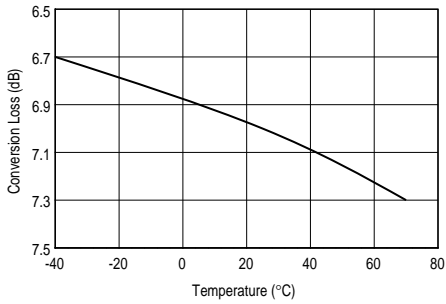

### IIP3 vs. Frequency

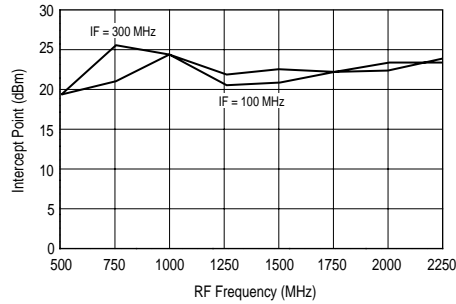

### IIP3 vs. LO Power

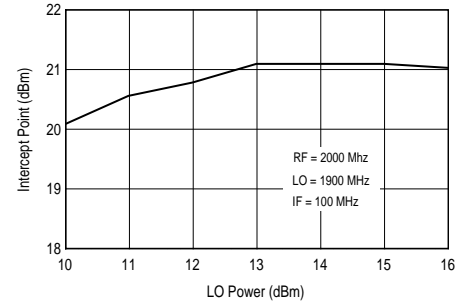

### VSWR vs. Frequency

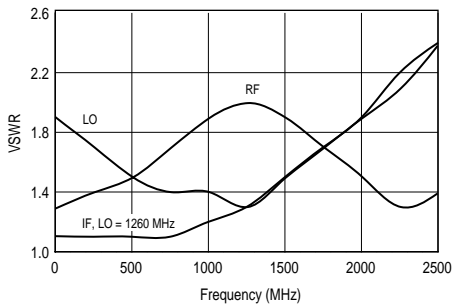

### Isolation vs. Frequency

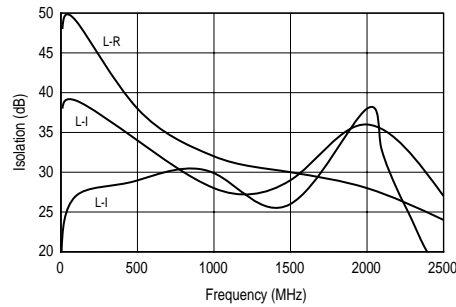

## Single-Tone IM Products

		Harmonics of fLO					
		0	1	2	3	4	5
Harmonics of fRF	0		22	27	28	39	34
	1	17	0	19	23	39	46
	2	64	60	61	60	65	73
	3	>80	77	>80	78	>80	>80
	4	>80	>80	>80	>80	>80	>80
	5	>80	>80	>80	>80	>80	>80

LO Mult	RF Mult	LO MHz	RF MHz	IM Prod MHz	IM Prod dB
0	1	2150	2200	2200	17
0	2	2150	2200	4400	64
0	3	2150	2200	6600	81
0	4	2150	2200	8800	86
0	5	2150	2200	11000	86
1	0	2150	2200	2150	22
-1	1	2150	2200	50	0
-1	2	2150	1100	50	60
-1	3	2150	734	52	77
-1	4	2150	550	50	92
-1	5	2150	440	50	89
2	0	2150	2200	4300	27
-2	1	2150	4350	50	19
-2	2	2150	2175	50	61
-2	3	2150	1450	50	85
-2	4	2150	1088	52	90
-2	5	2150	870	50	88
3	0	2150	2200	6450	28
-3	1	2150	6500	50	23
-3	2	2150	3250	50	60
-3	3	2150	2167	51	78
-3	4	2150	1625	50	89
-3	5	2150	1300	50	88
4	0	2150	2200	8600	39
-4	1	2150	8650	50	39
-4	2	2150	4325	50	65
-4	3	2150	2884	52	81
-4	4	2150	2163	52	90
-4	5	2150	1730	50	87
5	0	2150	2200	10750	34
-5	1	2150	10800	50	46
-5	2	2150	5400	50	73
-5	3	2150	3600	50	88
-5	4	2150	2700	50	89
-5	5	2150	2160	50	89

Test Conditions RF at -10 dBm; LO at +13 dBm

RF harmonics and intermodulation products are referenced to a desired signal produced by fRF = 2200 MHz and fLO = 2150 MHz.

LO harmonics are referenced to the LO drive signal.

## Outline Drawing

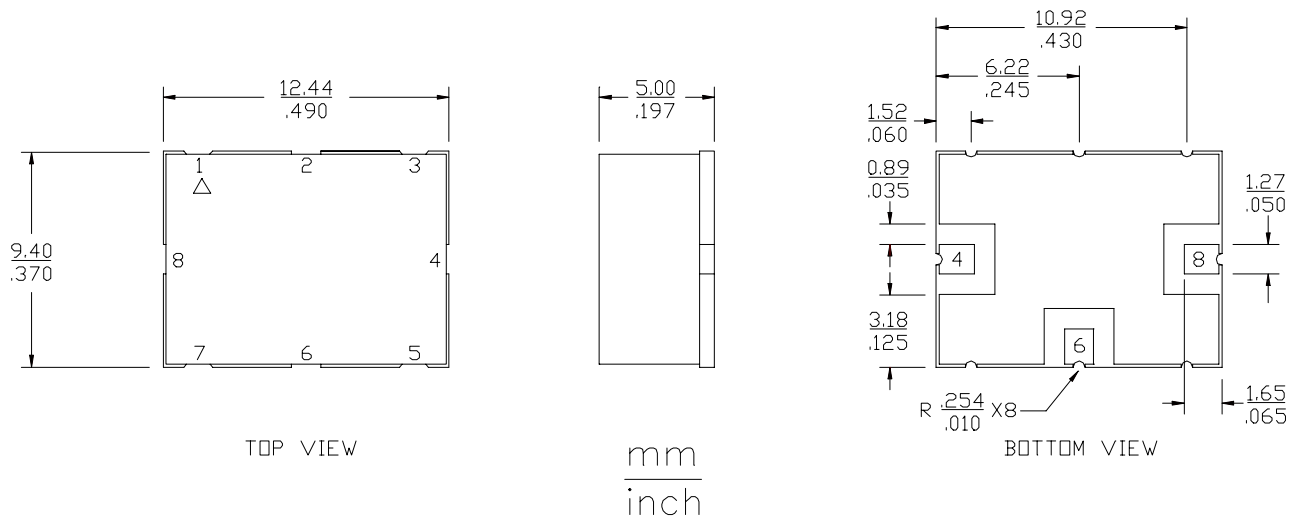

## Land Pattern

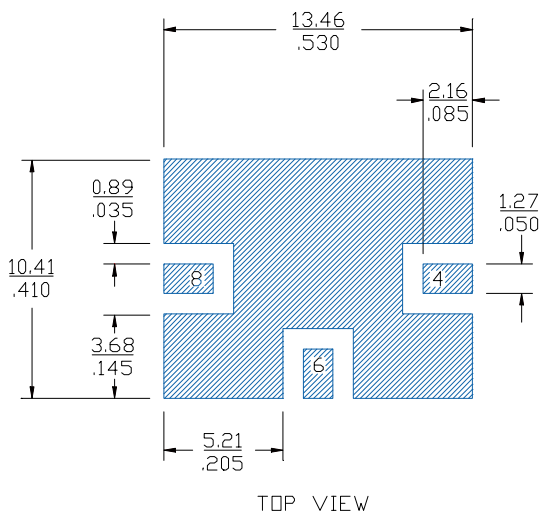

## Mounting Configuration

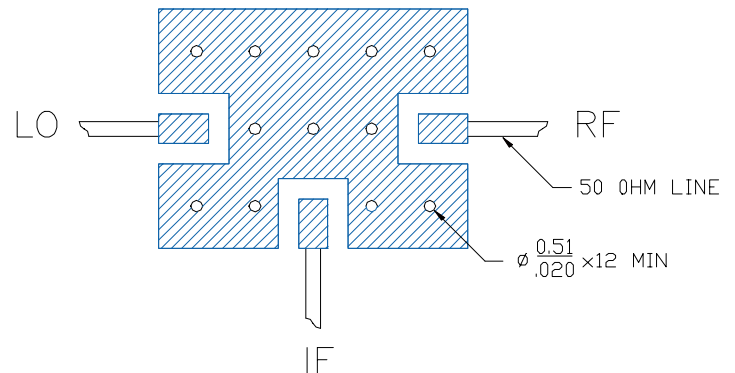

FUNCTION	PIN NO.
GROUND	1-3
RF	4
GROUND	5
IF	6
GROUND	7
LO	8

- Notes:
1. Ground vias are critical for thermal and RF grounding considerations.
  2. A minimum of 12 ground vias are required.
  3. If your PCB design rules allow, ground vias should be placed under the land pattern for better RF and thermal performance. Otherwise ground vias should be placed as close to land pattern as possible.
  4. Trace width depends on PC board.

