

## *Praetorian*™ L-C EMI Filter with ESD Protection for Headset Speaker Applications

### Features

- 2 channels of EMI filtering
- ±30kV ESD protection
- (IEC 61000-4-2, contact discharge)
- ±30kV ESD protection (HBM)
- OptiGuard Coating for improved reliability at assembly
- Greater than 30dB of attenuation at 1GHz
- 5-bump, 1.590mm x 1.220mm footprint Chip Scale Package (CSP)
- Lead-free version available

### Applications

- Headset Speaker port in mobile handsets
- I/O port protection for mobile handsets, notebook computers, PDAs etc.
- EMI filtering for data ports in cell phones, PDAs or notebook computers.

### Product Description

California Micro Devices' CM1419 is an L-C EMI filter array with ESD protection, which integrates two Pi-filters (C-L-C) for the headset speaker. The CM1419 has component values of 117pF-3.0nH-117pF. The parts include ESD protection diodes on all input/output pins, which provide a very high level of protection for sensitive electronic components that may be subjected to electrostatic discharge (ESD). The ESD diodes connected to the filter ports safely dissipate ESD strikes of ±30kV, beyond the maximum requirement of the IEC61000-4-2 international standard. Using the MIL-STD-883 (Method 3015) specification for Human Body Model (HBM) ESD, the pins are protected for contact discharges at greater than ±30kV.

This device is particularly well suited for portable electronics (e.g. mobile handsets, PDAs, notebook computers) because of its small package format and easy-to-use pin assignments. In particular, the CM1419 is ideal for EMI filtering and protecting speaker output lines from ESD for the headset speaker in mobile handsets. Most speakers have impedance of 8Ω and in order to maximize the power output, the resistance of an EMI filter needs to be as low as possible and the CM1419 addresses this by having a C-L-C based EMI filter where the inductor has less than 0.35Ω of resistance.

The CM1419 is available either uncoated or with *OptiGuard*™ coating resulting in improved reliability at assembly. The CM1419 is also available in a space saving, low profile Chip Scale Package with optional lead-free finishing.

### Electrical Schematic

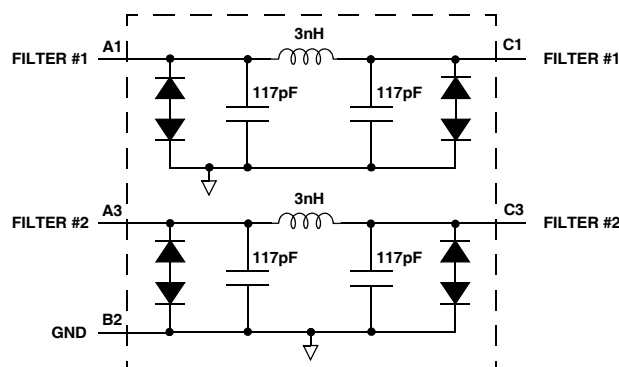

## PACKAGE / PINOUT DIAGRAMS

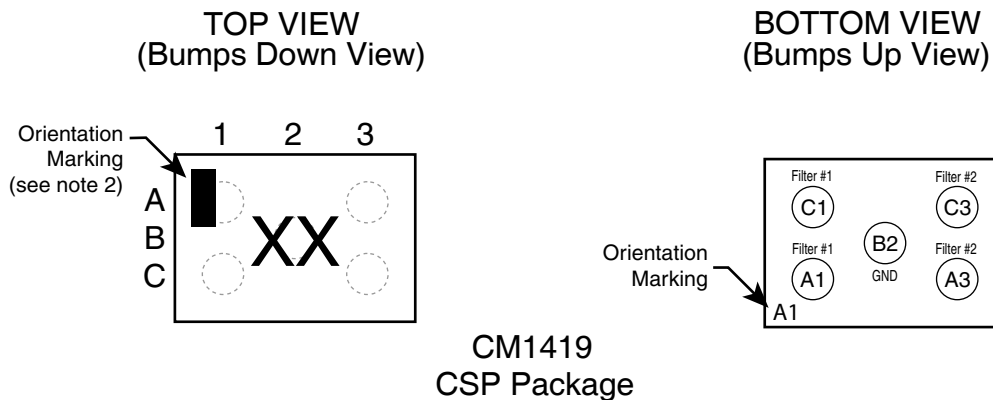

## Notes:

- 1) These drawings are not to scale.
- 2) Lead-free devices are specified by using a "+" character for the top side orientation mark.

## PIN DESCRIPTIONS

PIN	NAME	DESCRIPTION
A1	Filter #1	Filter #1 Input
C1	Filter #1	Filter #1 Input
A3	Filter #2	Filter #2 Input
C3	Filter #2	Filter #2 Input
B2	GND	Device Ground

## Ordering Information

## PART NUMBERING INFORMATION

Pins	Package	OptiGuard™ Coating	Standard Finish		Lead-free Finish <sup>2</sup>	
			Ordering Part Number <sup>1</sup>	Part Marking	Ordering Part Number <sup>1</sup>	Part Marking
5	CSP	Y	CM1419-02CS	CH	CM1419-02CP	CH
5	CSP	N	CM1419-0BCS	AM	CM1419-0BCP	AM

Note 1: Parts are shipped in Tape & Reel form unless otherwise specified.

Note 2: Lead-free devices are specified by using a "+" character for the top side orientation mark.

## Specifications

### ABSOLUTE MAXIMUM RATINGS

PARAMETER	RATING	UNITS
Storage Temperature Range	-65 to +150	°C
DC Current per Inductor	30	mA
DC Package Power Rating	0.5	W

### STANDARD OPERATING CONDITIONS

PARAMETER	RATING	UNITS
Operating Temperature Range	-40 to +85	°C

### ELECTRICAL OPERATING CHARACTERISTICS (SEE NOTE 1)

SYMBOL	PARAMETER	CONDITIONS	MIN	TYP	MAX	UNITS
L	Inductance			3.0		nH
R	DC Channel Resistance			0.28	0.35	Ω
C <sub>TOT</sub>	Total Channel Capacitance	2.5V dc; 1MHz, 30mV ac	187	234	281	pF
C <sub>1</sub>	Capacitance C <sub>1</sub>	2.5V dc; 1MHz, 30mV ac	93	117	140	pF
V <sub>ST</sub>	Stand-off Voltage	I = 10μA		6.0		V
I <sub>LEAK</sub>	Diode Leakage Current	V <sub>IN</sub> = ±3.3V		0.1	1.0	μA
V <sub>SIG</sub>	Signal Clamp Voltage Positive Clamp Negative Clamp	I <sub>LOAD</sub> = 10mA I <sub>LOAD</sub> = -10mA	5.6 -9.0	6.8 -6.8	9.0 -5.6	V V
V <sub>ESD</sub>	In-system ESD Withstand Voltage a) Human Body Model, MIL-STD-883, Method 3015 b) Contact Discharge per IEC 61000-4-2 Level 4	Notes 2 and 3	±30 ±30			kV kV
R <sub>DYN</sub>	Dynamic Resistance Positive Negative			0.95 0.90		Ω Ω
f <sub>C</sub>	Cut-off frequency Z <sub>SOURCE</sub> = 50Ω, Z <sub>LOAD</sub> = 50Ω	L = 3nH, C = 117pF		22		MHz

Note 1: T<sub>A</sub>=25°C unless otherwise specified.

Note 2: ESD applied to input and output pins with respect to GND, one at a time.

Note 3: These parameters are guaranteed by design and characterization.

### Performance Information

Typical Filter Performance (nominal conditions unless specified otherwise, 50 Ohm Environment)

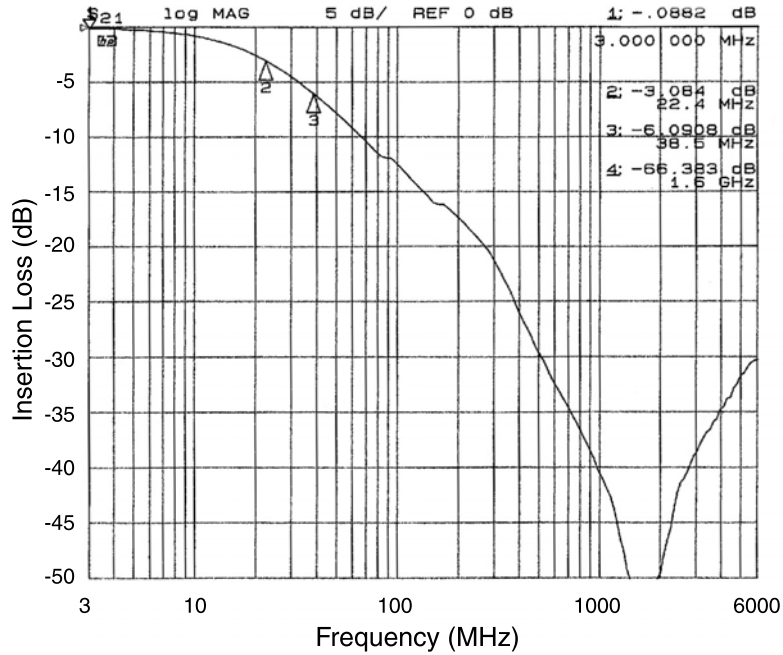

Figure 1. Insertion Loss vs. Frequency (Filter #1 to GND B2)

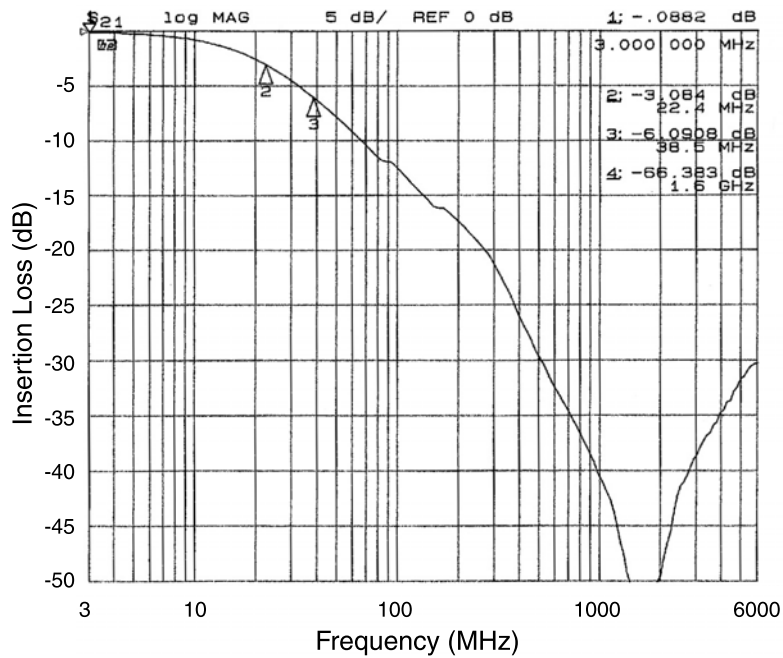
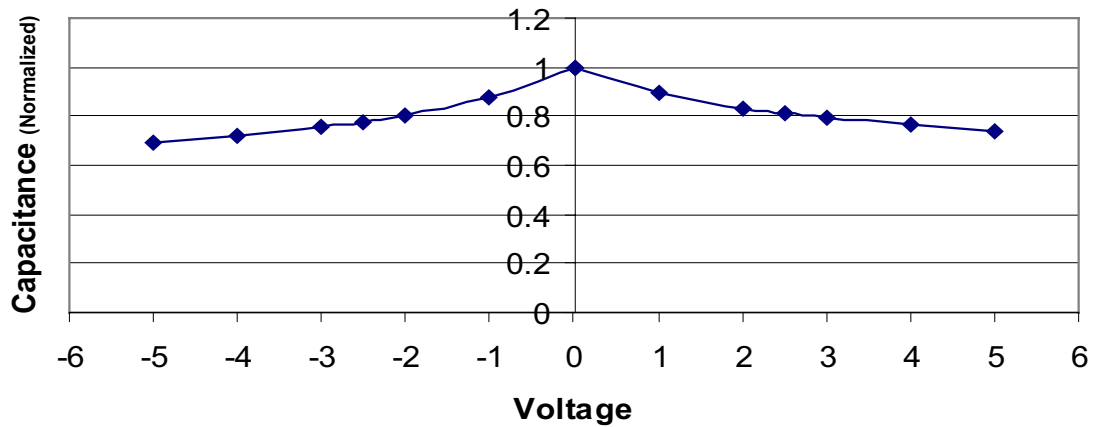

Figure 2. Insertion Loss vs. Frequency (Filter #2 to GND B2)



**Figure 3. Typical Diode Capacitance vs. Input Voltage (normalized to 2.5V d.c.)**

**Application Information**

Refer to Application Note AP-217, "The Chip Scale Package", for a detailed description of Chip Scale Packages offered by California Micro Devices.

**PRINTED CIRCUIT BOARD RECOMMENDATIONS**

PARAMETER	VALUE
Pad Size on PCB	0.275mm
Pad Shape	Round
Pad Definition	Non-Solder Mask defined pads
Solder Mask Opening	0.325mm Round
Solder Stencil Thickness	0.125 - 0.150mm
Solder Stencil Aperture Opening (laser cut, 5% tapered walls)	0.330mm Round
Solder Flux Ratio	50/50 by volume
Solder Paste Type	No Clean
Pad Protective Finish	OSP (Entek Cu Plus 106A)
Tolerance — Edge To Corner Ball	±50µm
Solder Ball Side Coplanarity	±20µm
Maximum Dwell Time Above Liquidous	60 seconds
Maximum Soldering Temperature for Eutectic Devices using a Eutectic Solder Paste	240°C
Maximum Soldering Temperature for Lead-free Devices using a Lead-free Solder Paste	260°C

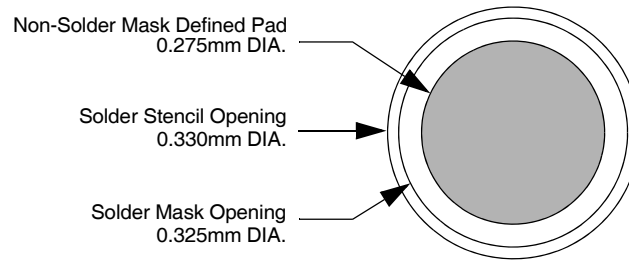

**Figure 4. Recommended Non-Solder Mask Defined Pad Illustration**

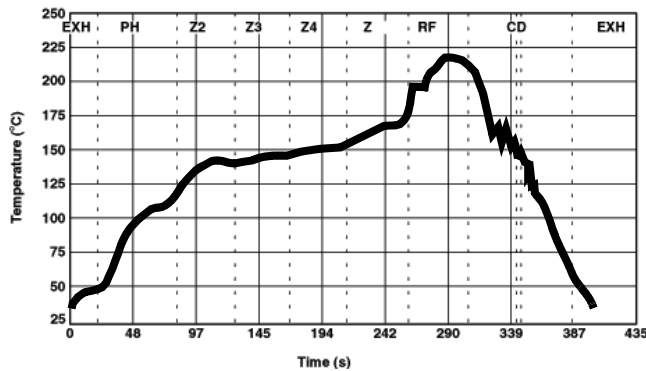

**Figure 5. Eutectic (SnPb) Solder Ball Reflow Profile**

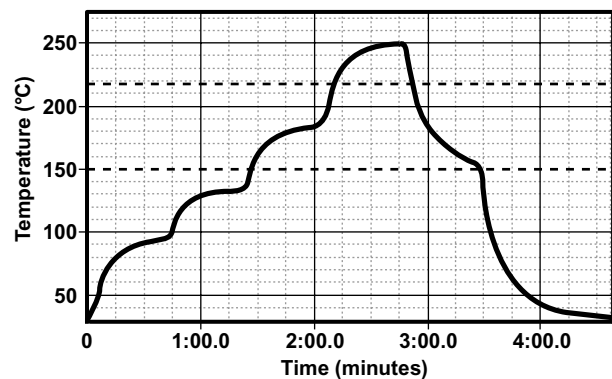

**Figure 6. Lead-free (SnAgCu) Solder Ball Reflow Profile**

**Mechanical Details**

**CM1419 CSP Mechanical Specifications**

The CM1419 is supplied in 5-bump Chip Scale Package (CSP). Dimensions are presented below.

PACKAGE DIMENSIONS						
Package	Custom CSP					
Bumps	5					
Dim	Millimeters			Inches		
	Min	Nom	Max	Min	Nom	Max
<b>A1</b>	1.175	1.220	1.265	0.0463	0.0480	0.0498
<b>A2</b>	1.545	1.590	1.635	0.0608	0.0626	0.0644
<b>B1</b>	0.495	0.500	0.505	0.0195	0.0197	0.0199
<b>B2</b>	0.245	0.250	0.255	0.0096	0.0098	0.0100
<b>B3</b>	0.430	0.435	0.440	0.0169	0.0171	0.0173
<b>C1</b>	0.310	0.360	0.410	0.0122	0.042	0.0161
<b>C2</b>	0.310	0.360	0.410	0.0122	0.042	0.0161
<b>D1</b>	0.562	0.606	0.650	0.0221	0.0239	0.0256
<b>D2</b>	0.356	0.381	0.406	0.0140	0.0150	0.0160
<b>D3</b>	0.575	0.644	0.714	0.0226	0.0254	0.0281
<b>D4</b>	0.368	0.419	0.470	0.0145	0.0165	0.0185
<b># per tape and reel</b>	3500 pieces					
Controlling dimension: millimeters						

**Mechanical Package Diagrams**

**Non-Coated CSP**

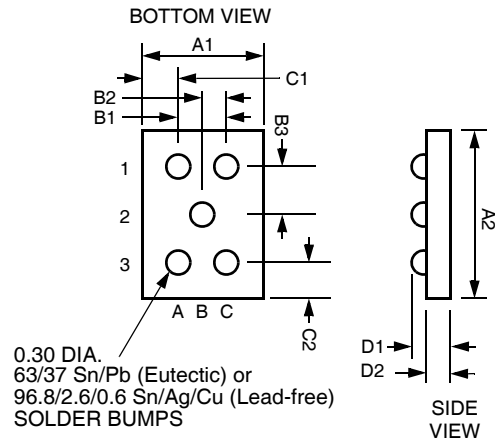

**OptiGuard™ Coated CSP**

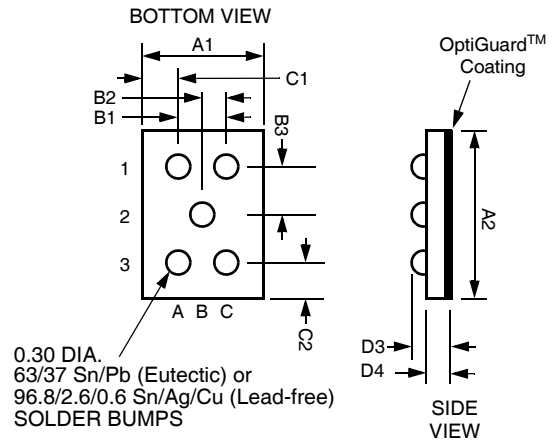

NOTE: DIMENSIONS IN MILLIMETERS

**Package Dimensions for CM1419-0xCS/CP  
5-bump Chip Scale Package**

**Mechanical Details (cont'd)**

**CSP Tape and Reel Specifications**

PART NUMBER	CHIP SIZE (mm)	POCKET SIZE (mm) $B_0 \times A_0 \times K_0$	TAPE WIDTH W	REEL DIA.	QTY PER REEL	$P_0$	$P_1$
CM1419-02CS/CP	1.59 X 1.22 X 0.64	2.08 x 1.45 x 0.71	8mm	178mm (7")	3500	4mm	4mm
CM1419-0BCS/CP	1.59 X 1.22 X 0.60	2.08 x 1.45 x 0.71	8mm	178mm (7")	3500	4mm	4mm

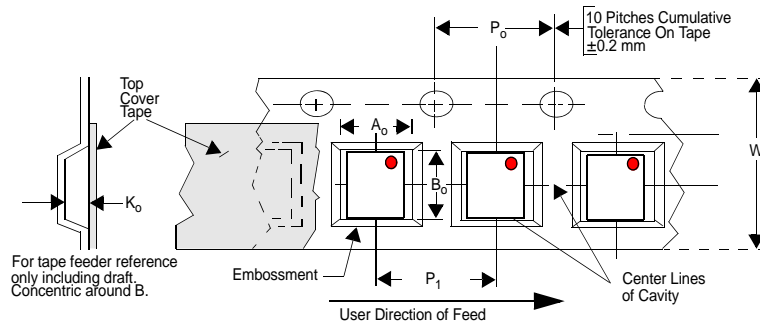

**Figure 7. Tape and Reel Mechanical Data**