



AO4406

N-Channel Enhancement Mode Field Effect Transistor

General Description

The AO4406 uses advanced trench technology to provide excellent $R_{DS(ON)}$, low gate charge and operation with gate voltages as low as 2.5V. This device makes an excellent high side switch for notebook CPU core DC-DC conversion.

Features

- V_{DS} (V) = 30V
- I_D = 11.5A
- $R_{DS(ON)} < 14m\Omega$ ($V_{GS} = 10V$)
- $R_{DS(ON)} < 16.5m\Omega$ ($V_{GS} = 4.5V$)
- $R_{DS(ON)} < 26m\Omega$ ($V_{GS} = 2.5V$)

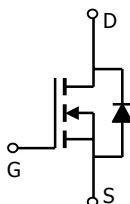
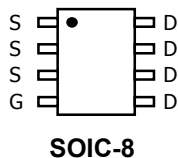

Absolute Maximum Ratings $T_A=25^\circ C$ unless otherwise noted

Parameter	Symbol	Maximum	Units
Drain-Source Voltage	V_{DS}	30	V
Gate-Source Voltage	V_{GS}	± 12	V
Continuous Drain Current ^A	$T_A=25^\circ C$	11.5	A
	$T_A=70^\circ C$	9.6	
Pulsed Drain Current ^B	I_{DM}	80	
Avalanche Current ^{B,E}	I_{AV}	25	A
Repetitive Avalanche Energy ^{B,E} L=0.1mH	E_{AV}	78	mJ
Power Dissipation	$T_A=25^\circ C$	3	W
	$T_A=70^\circ C$	2.1	
Junction and Storage Temperature Range	T_J, T_{STG}	-55 to 150	$^\circ C$

Thermal Characteristics

Parameter		Symbol	Typ	Max	Units
Maximum Junction-to-Ambient ^A	$t \leq 10s$	$R_{\theta JA}$	23	40	$^\circ C/W$
Maximum Junction-to-Ambient ^A	Steady-State		48	65	$^\circ C/W$
Maximum Junction-to-Lead ^C	Steady-State	$R_{\theta JL}$	12	16	$^\circ C/W$

Electrical Characteristics (T_J=25°C unless otherwise noted)

Symbol	Parameter	Conditions	Min	Typ	Max	Units
STATIC PARAMETERS						
BV _{DSS}	Drain-Source Breakdown Voltage	I _D =250μA, V _{GS} =0V	30			V
I _{DSS}	Zero Gate Voltage Drain Current	V _{DS} =24V, V _{GS} =0V T _J =55°C			1 5	μA
I _{GSS}	Gate-Body leakage current	V _{DS} =0V, V _{GS} = ±12V			100	nA
V _{GS(th)}	Gate Threshold Voltage	V _{DS} =V _{GS} , I _D =250μA	0.8	1	1.5	V
I _{D(ON)}	On state drain current	V _{GS} =4.5V, V _{DS} =5V	60			A
R _{DS(ON)}	Static Drain-Source On-Resistance	V _{GS} =10V, I _D =12A T _J =125°C		11.5	14	mΩ
		V _{GS} =4.5V, I _D =10A		13.5	16.5	mΩ
		V _{GS} =2.5V, I _D =8A		19.5	26	mΩ
g _{FS}	Forward Transconductance	V _{DS} =5V, I _D =10A	25	38		S
V _{SD}	Diode Forward Voltage	I _S =10A, V _{GS} =0V		0.83	1	V
I _S	Maximum Body-Diode Continuous Current				4.5	A
DYNAMIC PARAMETERS						
C _{iss}	Input Capacitance	V _{GS} =0V, V _{DS} =15V, f=1MHz		1630		pF
C _{oss}	Output Capacitance			201		pF
C _{rss}	Reverse Transfer Capacitance			142		pF
R _g	Gate resistance	V _{GS} =0V, V _{DS} =0V, f=1MHz		0.8		Ω
SWITCHING PARAMETERS						
Q _g	Total Gate Charge	V _{GS} =4.5V, V _{DS} =15V, I _D =11.5A		18		nC
Q _{gs}	Gate Source Charge			2.5		nC
Q _{gd}	Gate Drain Charge			5.5		nC
t _{D(on)}	Turn-On Delay Time	V _{GS} =10V, V _{DS} =15V, R _L =1.2Ω, R _{GEN} =3Ω		4		ns
t _r	Turn-On Rise Time			5		ns
t _{D(off)}	Turn-Off Delay Time			32		ns
t _f	Turn-Off Fall Time			5		ns
t _{rr}	Body Diode Reverse Recovery Time	I _F =10A, dI/dt=100A/μs		18,7		ns
Q _{rr}	Body Diode Reverse Recovery Charge	I _F =10A, dI/dt=100A/μs		19.8		nC

A: The value of R_{θJA} is measured with the device mounted on 1in² FR-4 board with 2oz. Copper, in a still air environment with T_A=25°C. The value in any a given application depends on the user's specific board design. The current rating is based on the t ≤ 10s thermal resistance rating.

B: Repetitive rating, pulse width limited by junction temperature.

C: The R_{θJA} is the sum of the thermal impedance from junction to lead R_{θJL} and lead to ambient.

D: The static characteristics in Figures 1 to 6 are obtained using 80μs pulses, duty cycle 0.5% max.

E: These tests are performed with the device mounted on 1 in² FR-4 board with 2oz. Copper, in a still air environment with T_A=25°C. The SOA curve provides a single pulse rating.

TYPICAL ELECTRICAL AND THERMAL CHARACTERISTICS

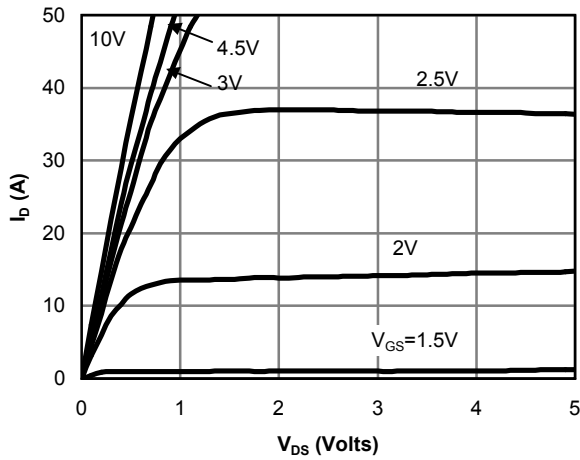

Fig 1: On-Region Characteristics

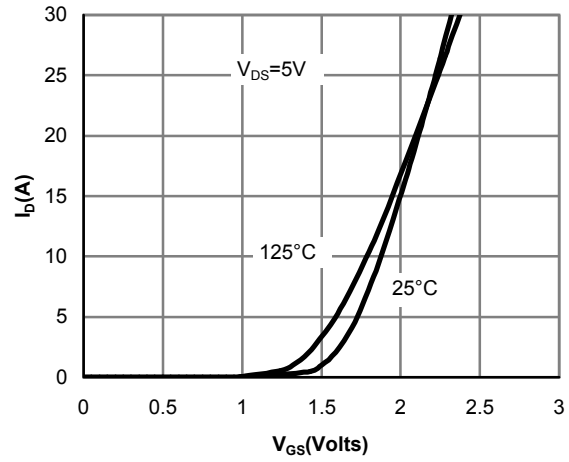

Figure 2: Transfer Characteristics

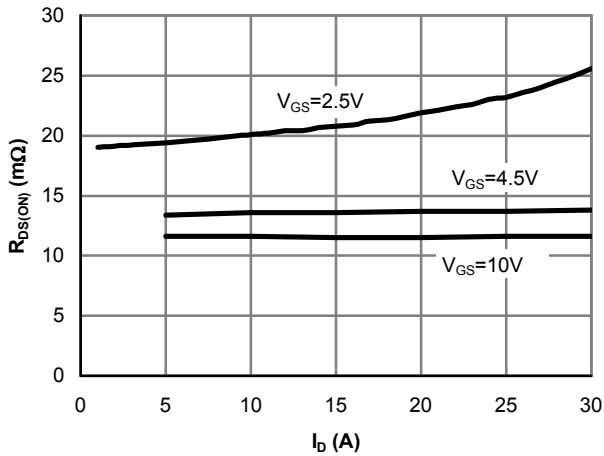

Figure 3: On-Resistance vs. Drain Current and Gate Voltage

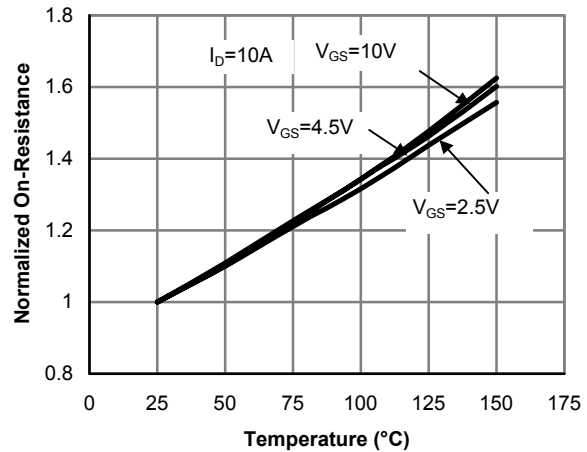

Figure 4: On-Resistance vs. Junction Temperature

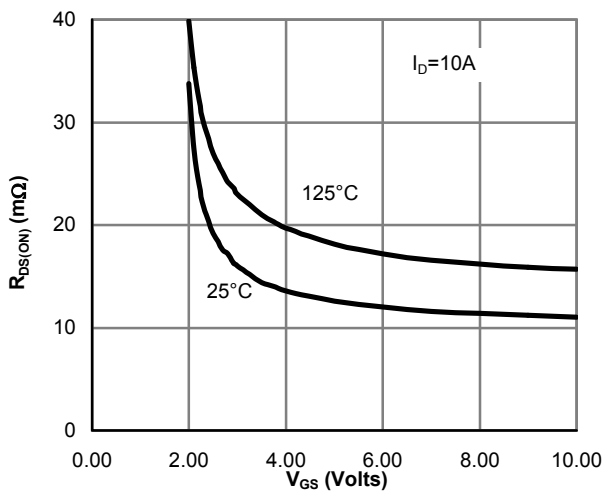

Figure 5: On-Resistance vs. Gate-Source Voltage

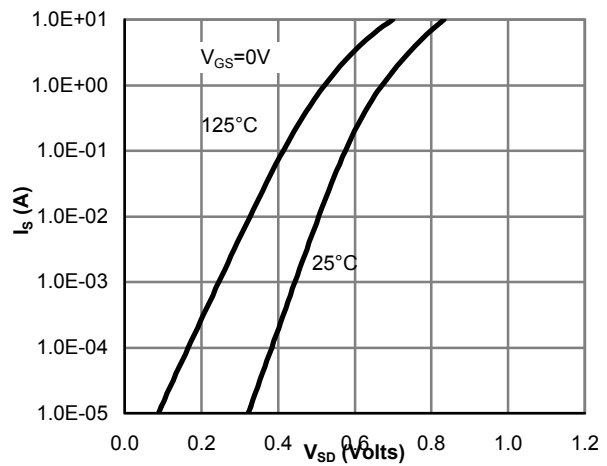

Figure 6: Body-Diode Characteristics

TYPICAL ELECTRICAL AND THERMAL CHARACTERISTICS

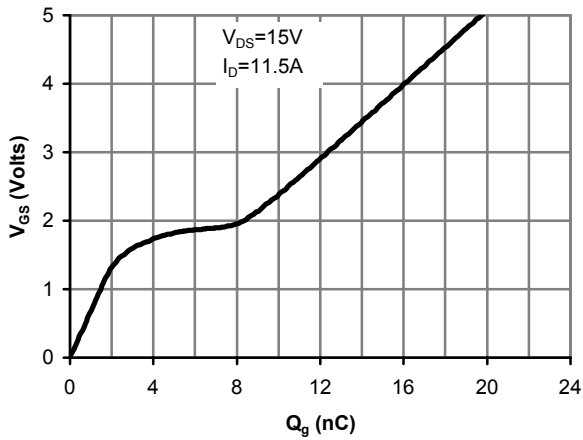

Figure 7: Gate-Charge Characteristics

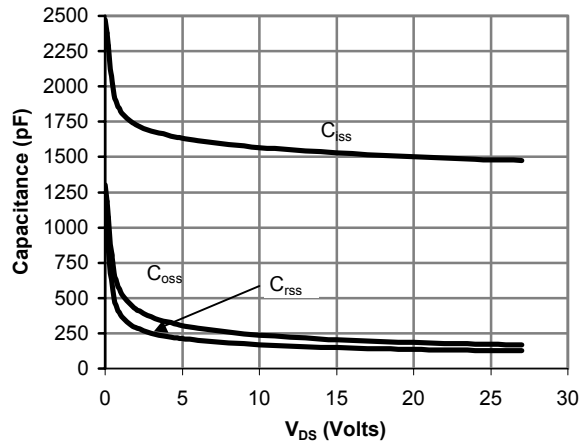

Figure 8: Capacitance Characteristics

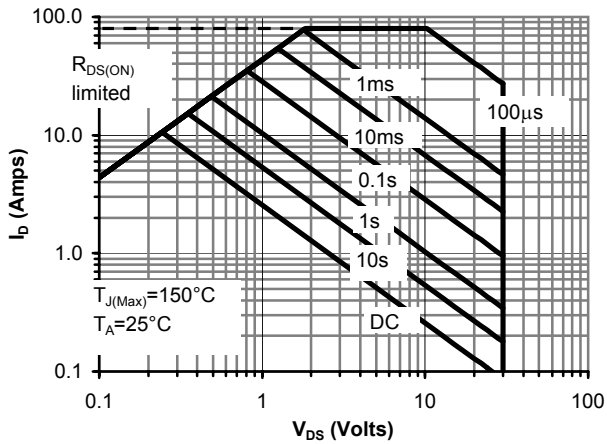

Figure 9: Maximum Forward Biased Safe Operating Area (Note E)

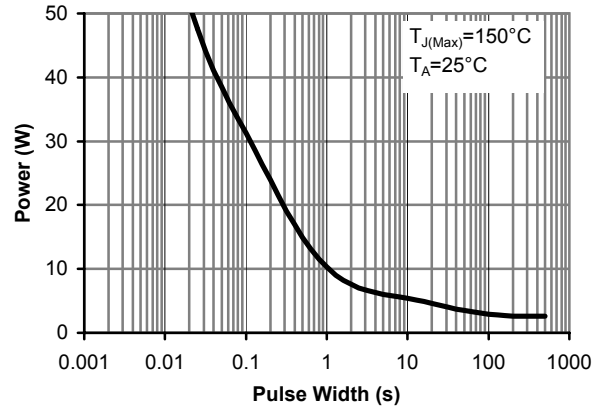

Figure 10: Single Pulse Power Rating Junction-to-Ambient (Note E)

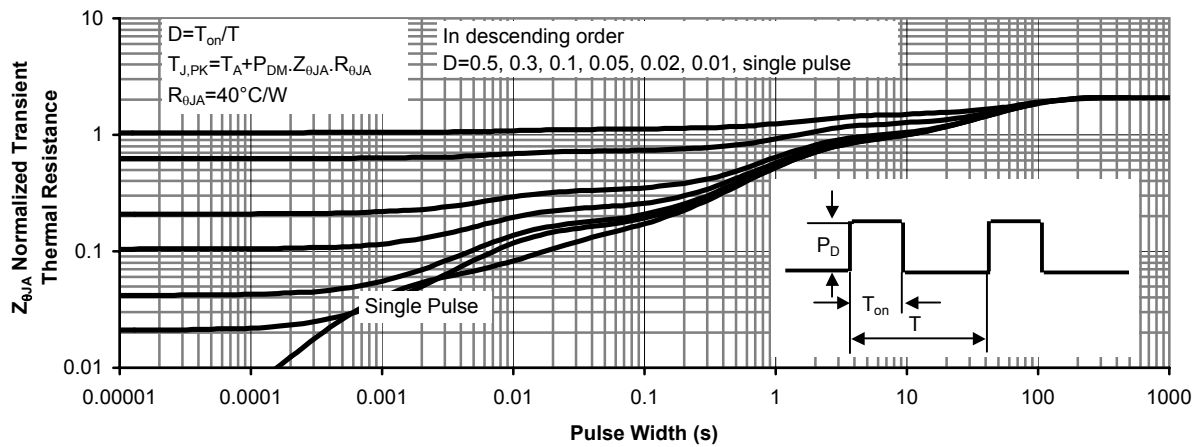

Figure 11: Normalized Maximum Transient Thermal Impedance

TYPICAL ELECTRICAL AND THERMAL CHARACTERISTICS

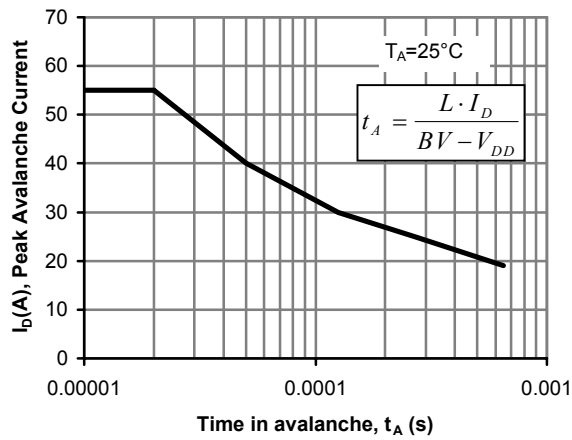

Figure 12: Avalanche capability

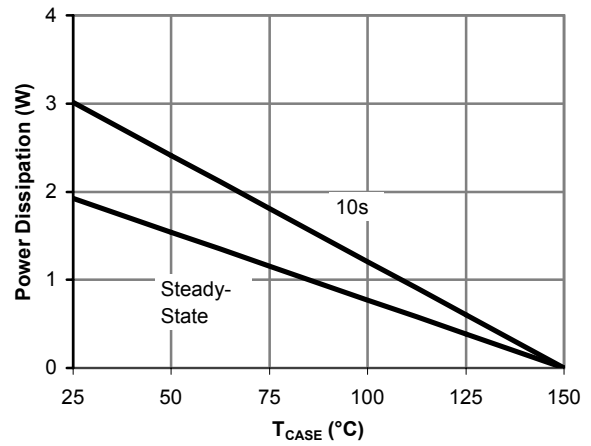
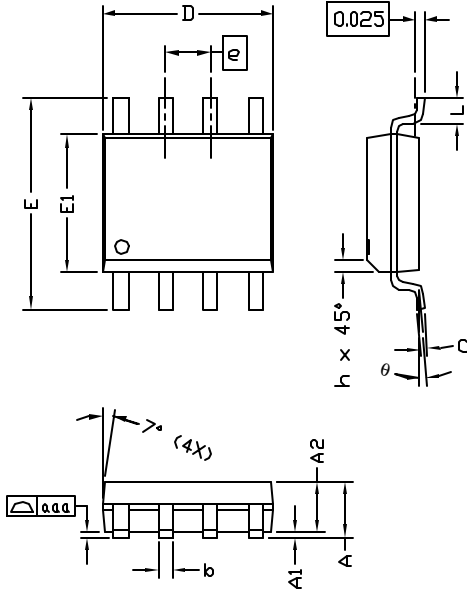

Figure 13: Power De-rating (Note A)



ALPHA & OMEGA
SEMICONDUCTOR, INC.

SO-8 Package Data



SYMBOLS	DIMENSIONS IN MILLIMETERS			DIMENSIONS IN INCHES		
	MIN	NOM	MAX	MIN	NOM	MAX
A	1.45	1.50	1.55	0.057	0.059	0.061
A1	0.00	—	0.10	0.000	—	0.004
A2	—	1.45	—	—	0.057	—
b	0.33	—	0.51	0.013	—	0.020
c	0.19	—	0.25	0.007	—	0.010
D	4.80	—	5.00	0.189	—	0.197
E1	3.80	—	4.00	0.150	—	0.157
e	1.27 BSC			0.050 BSC		
E	5.80	—	6.20	0.228	—	0.244
h	0.25	—	0.50	0.010	—	0.020
L	0.40	—	1.27	0.016	—	0.050
aaa	—	—	0.10	—	—	0.004
θ	0°	—	8°	0°	—	8°

- NOTE:
 1. LEAD FINISH: 150 MICROINCHES (3.8 um) MIN.
 THICKNESS OF Tin/Lead (SOLDER) PLATED ON LEAD
 2. TOLERANCE ±0.10 mm (4 mil) UNLESS OTHERWISE SPECIFIED
 3. COPLANARITY : 0.10 mm
 4. DIMENSION L IS MEASURED IN GAGE PLANE

PACKAGE MARKING DESCRIPTION

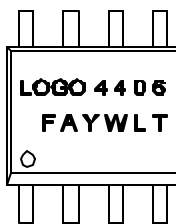

- NOTE:
 LOGO - AOS LOGO
 4406 - PART NUMBER CODE.
 F - FAB LOCATION
 A - ASSEMBLY LOCATION
 Y - YEAR CODE
 W - WEEK CODE
 L N - ASSEMBLY LOT CODE

SO-8 PART NO. CODE

PART NO.	CODE
AO4406	4406

RECOMMENDED LAND PATTERN

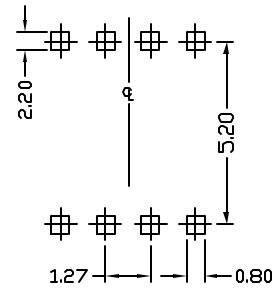

UNIT: mm



SO-8 Carrier Tape

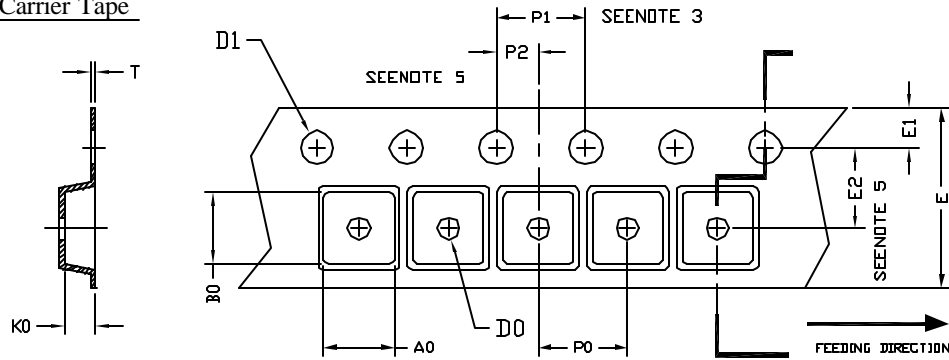

UNIT: MM

PACKAGE	A0	B0	K0	D0	D1	E	E1	E2	P0	P1	P2	T
SO-8 (12 mm)	6.40 ±0.10	5.20 ±0.10	2.10 ±0.10	1.60 ±0.10	1.30 ±0.10	12.00 ±0.30	1.75 ±0.10	5.50 ±0.05	8.00 ±0.10	4.00 ±0.10	2.00 ±0.05	0.25 ±0.05

SO-8 Reel

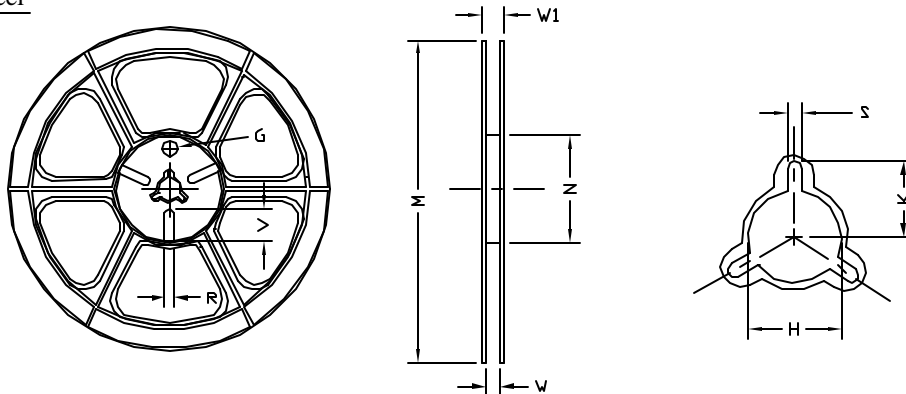

UNIT: MM

TAPE SIZE	REEL SIZE	M	N	W	W1	H	K	S	G	R	V
12 mm	φ330	φ330.00 ±0.50	φ97.00 ±0.10	13.00 ±0.30	17.40 ±1.00	φ13.00 +0.50 -0.20	10.60	2.00 ±0.50	---	---	---

SO-8 Tape

Leader / Trailer
& Orientation

