

**Full - Bridge
NPT IGBT Power Module**

**$V_{CES} = 1200V$
 $I_C = 25A @ T_c = 80^\circ C$**

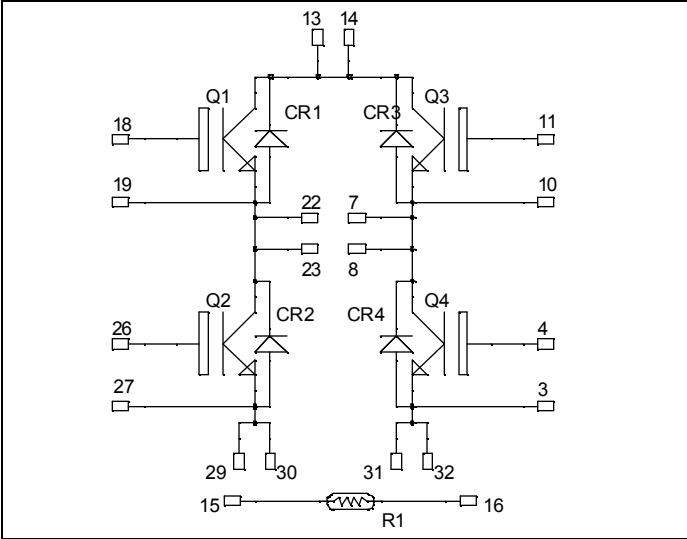

Application

- Welding converters
- Switched Mode Power Supplies
- Uninterruptible Power Supplies
- Motor control

Features

- Non Punch Through (NPT) Fast IGBT®
 - Low voltage drop
 - Low tail current
 - Switching frequency up to 50 kHz
 - Soft recovery parallel diodes
 - Low diode VF
 - Low leakage current
 - Avalanche energy rated
 - RBSOA and SCSOA rated
 - Symmetrical design
- Kelvin emitter for easy drive
- Very low stray inductance
- High level of integration
- Internal thermistor for temperature monitoring

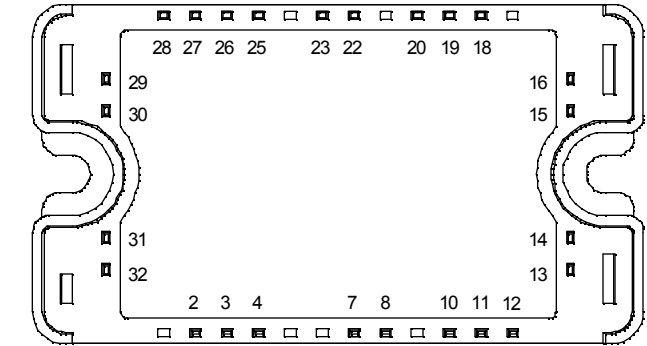

All multiple inputs and outputs must be shorted together
Example: 13/14 ; 29/30 ; 22/23 ...

Benefits

- Outstanding performance at high frequency operation
- Direct mounting to heatsink (isolated package)
- Low junction to case thermal resistance
- Solderable terminals both for power and signal for easy PCB mounting
- Low profile
- Easy paralleling due to positive TC of VCEsat
- Each leg can be easily paralleled to achieve a phase leg of twice the current capability

Absolute maximum ratings

Symbol	Parameter	Max ratings	Unit
V_{CES}	Collector - Emitter Breakdown Voltage	1200	V
I_C	Continuous Collector Current	$T_c = 25^\circ C$	40
		$T_c = 80^\circ C$	25
I_{CM}	Pulsed Collector Current	$T_c = 25^\circ C$	100
V_{GE}	Gate - Emitter Voltage	± 20	V
P_D	Maximum Power Dissipation	$T_c = 25^\circ C$	208
RBSOA	Reverse Bias Safe Operating Area	$T_j = 125^\circ C$	50A@1150V

CAUTION: These Devices are sensitive to Electrostatic Discharge. Proper Handling Procedures Should Be Followed.

All ratings @ $T_j = 25^\circ\text{C}$ unless otherwise specified

Electrical Characteristics

Symbol	Characteristic	Test Conditions	Min	Typ	Max	Unit
BV_{CES}	Collector - Emitter Breakdown Voltage	$V_{GE} = 0\text{V}, I_C = 500\mu\text{A}$	1200			V
I_{CES}	Zero Gate Voltage Collector Current	$V_{GE} = 0\text{V}$		1	500	μA
		$V_{CE} = 1200\text{V}$		1		mA
$V_{CE(on)}$	Collector Emitter on Voltage	$V_{GE} = 15\text{V}$	2.5	3.2	3.7	V
		$I_C = 25\text{A}$		4.0		
$V_{GE(th)}$	Gate Threshold Voltage	$V_{GE} = V_{CE}, I_C = 1\text{mA}$	4		6	V
I_{GES}	Gate - Emitter Leakage Current	$V_{GE} = 20\text{V}, V_{CE} = 0\text{V}$			400	nA

Dynamic Characteristics

Symbol	Characteristic	Test Conditions	Min	Typ	Max	Unit	
C_{ies}	Input Capacitance	$V_{GE} = 0\text{V}$		1650		pF	
C_{oes}	Output Capacitance	$V_{CE} = 25\text{V}$		250			
C_{res}	Reverse Transfer Capacitance	$f = 1\text{MHz}$		110			
Q_g	Total gate Charge	$V_{GE} = 15\text{V}$		160		nC	
Q_{ge}	Gate - Emitter Charge	$V_{Bus} = 300\text{V}$		10			
Q_{gc}	Gate - Collector Charge	$I_C = 25\text{A}$		70			
$T_{d(on)}$	Turn-on Delay Time	Inductive Switching (25°C) $V_{GE} = 15\text{V}$ $V_{Bus} = 400\text{V}$ $I_C = 25\text{A}$ $R_G = 22\Omega$		60		ns	
T_r	Rise Time			50			
$T_{d(off)}$	Turn-off Delay Time			305			
T_f	Fall Time			30			
$T_{d(on)}$	Turn-on Delay Time	Inductive Switching (125°C) $V_{GE} = 15\text{V}$ $V_{Bus} = 400\text{V}$ $I_C = 25\text{A}$ $R_G = 22\Omega$		60		ns	
T_r	Rise Time			50			
$T_{d(off)}$	Turn-off Delay Time			346			
T_f	Fall Time			40			
E_{on}	Turn-on Switching Energy ①			3.5			mJ
E_{off}	Turn-off Switching Energy ②			1.5			

① E_{on} includes diode reverse recovery

② In accordance with JEDEC standard JESD24-1

Reverse diode ratings and characteristics

Symbol	Characteristic	Test Conditions	Min	Typ	Max	Unit
V_{RRM}	Maximum Peak Repetitive Reverse Voltage		1200			V
I_{RM}	Maximum Reverse Leakage Current	$V_R = 1200\text{V}$			250	μA
					500	
$I_{F(AV)}$	Maximum Average Forward Current	50% duty cycle		25		A
V_F	Diode Forward Voltage	$I_F = 25\text{A}$		2.3	2.8	V
		$V_{GE} = 0\text{V}$		1.8		
t_{rr}	Reverse Recovery Time	$I_F = 25\text{A}$		0.13		μs
Q_{rr}	Reverse Recovery Charge	$V_R = 600\text{V}$		2.3		μC
		$di/dt = 800\text{A}/\mu\text{s}$		6		

Temperature sensor NTC

Symbol Characteristic

		<i>Min</i>	<i>Typ</i>	<i>Max</i>	<i>Unit</i>
R ₂₅	Resistance @ 25°C		68		kΩ
B _{25/85}	T ₂₅ = 298.16 K		4080		K

$$R_T = \frac{R_{25}}{\exp\left[B_{25/85}\left(\frac{1}{T_{25}} - \frac{1}{T}\right)\right]}$$

T: Thermistor temperature
R_T: Thermistor value at T

Thermal and package characteristics

Symbol Characteristic

		<i>Min</i>	<i>Typ</i>	<i>Max</i>	<i>Unit</i>	
R _{thJC}	Junction to Case	IGBT		0.6	°C/W	
		Diode		1		
V _{ISOL}	RMS Isolation Voltage, any terminal to case t=1 min, I _{isol} <1mA, 50/60Hz	2500			V	
T _J	Operating junction temperature range	-40		150	°C	
T _{STG}	Storage Temperature Range	-40		125		
T _C	Operating Case Temperature	-40		100		
Torque	Mounting torque		To heatsink	M4	4.7	N.m
Wt	Package Weight				110	g

Package outline

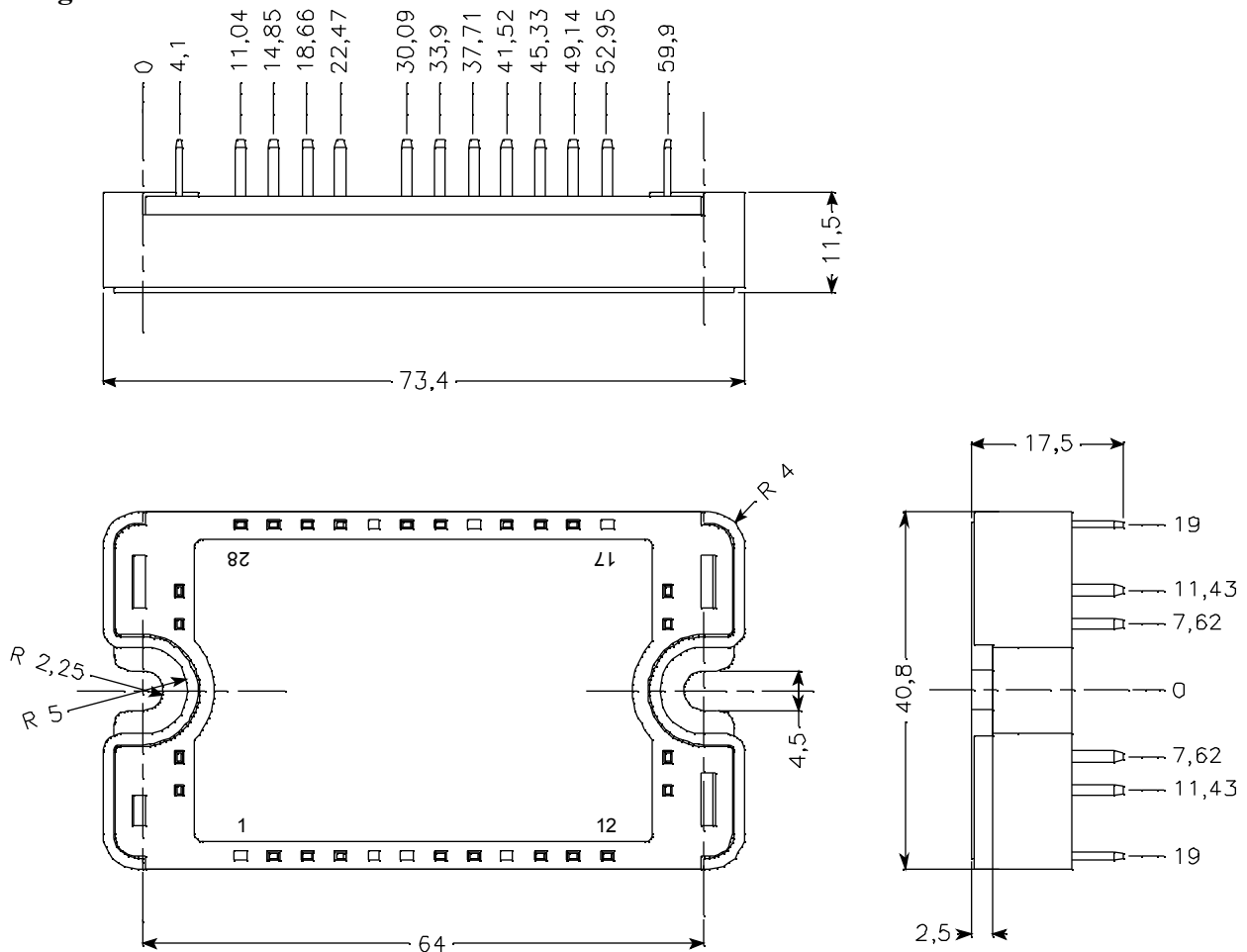

Typical Performance Curve

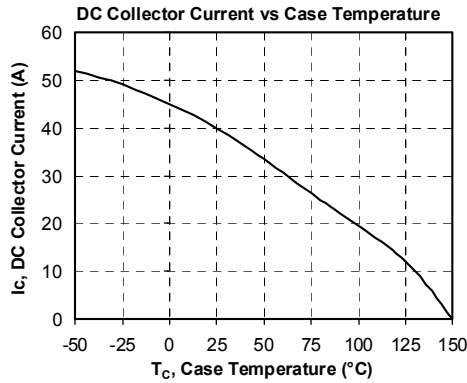
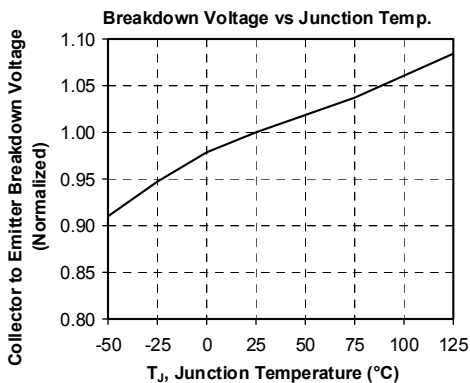
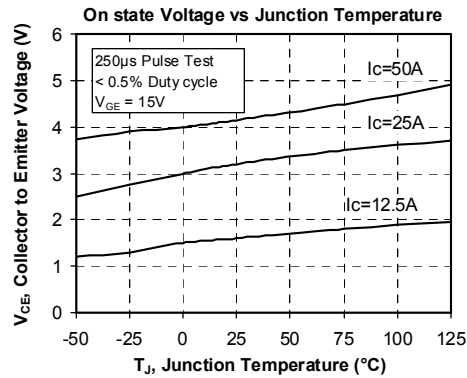
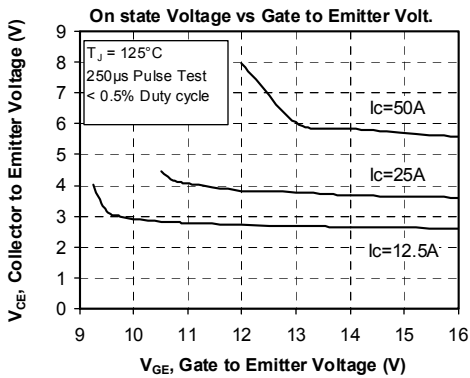
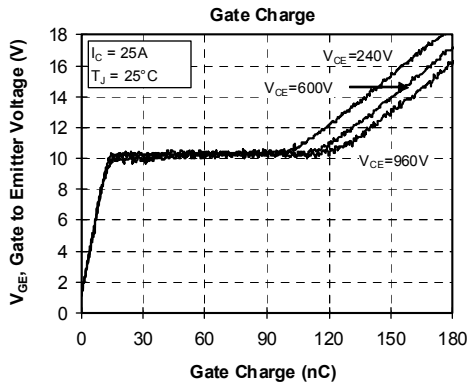
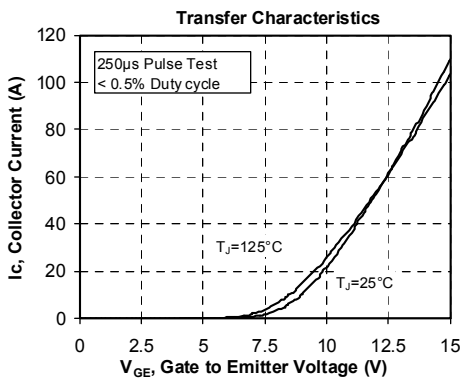
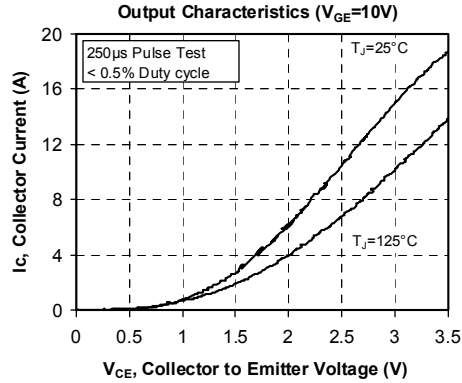
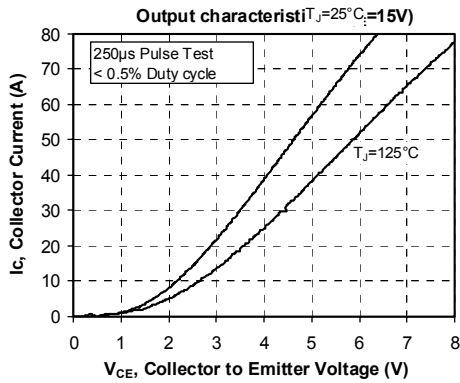

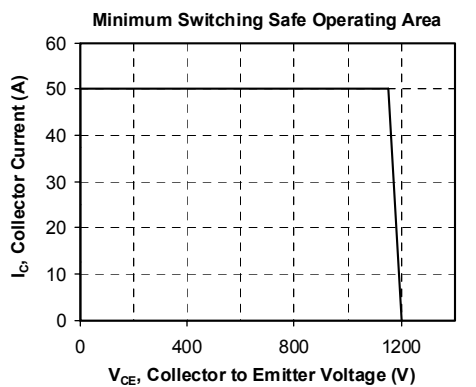
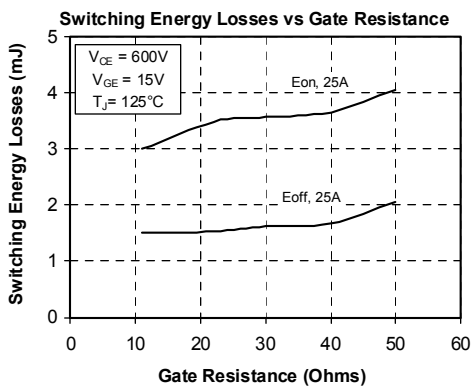
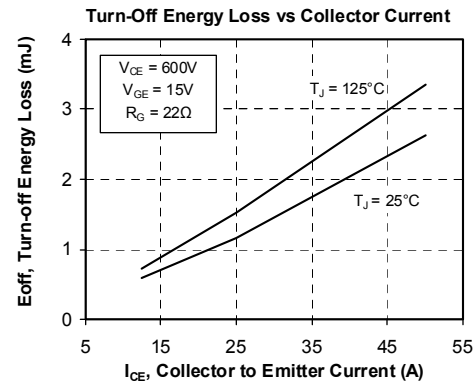
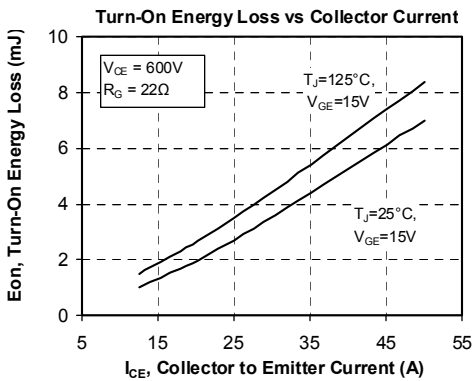
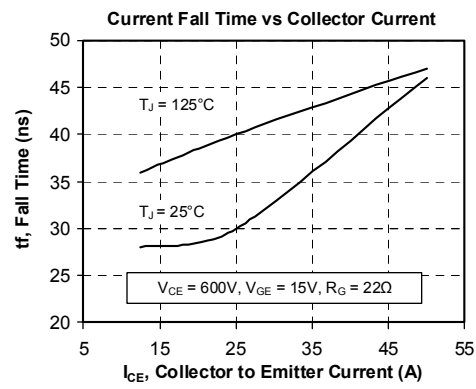
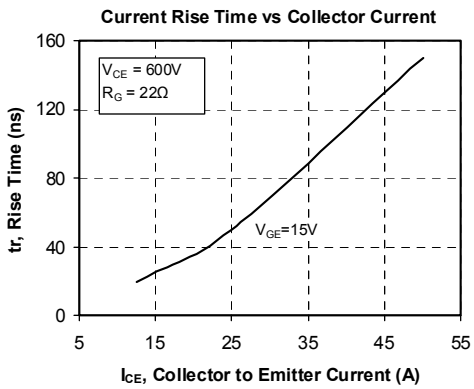
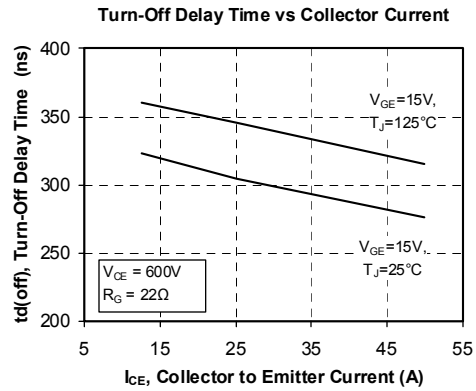
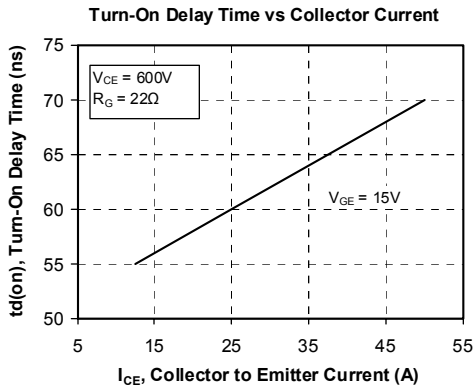

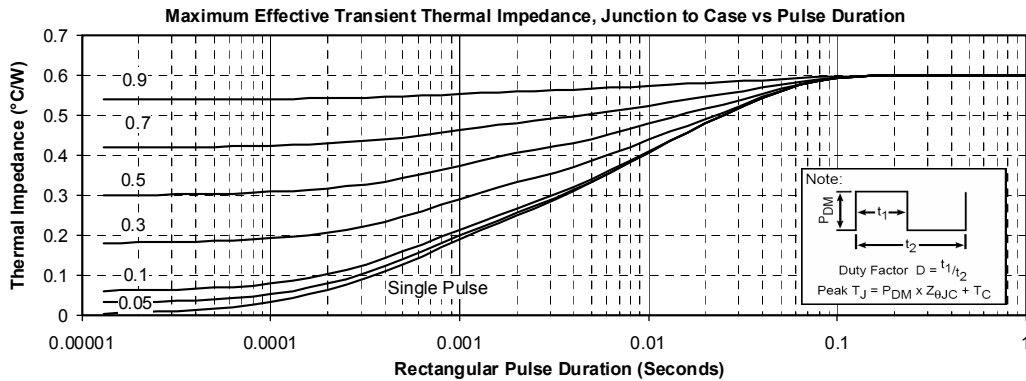
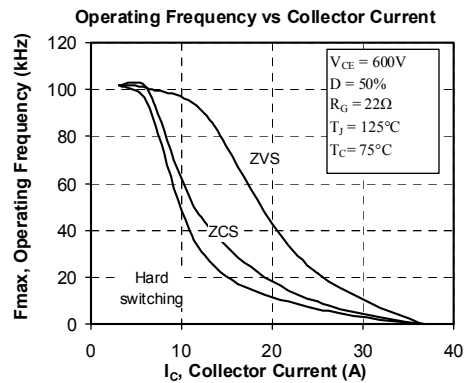
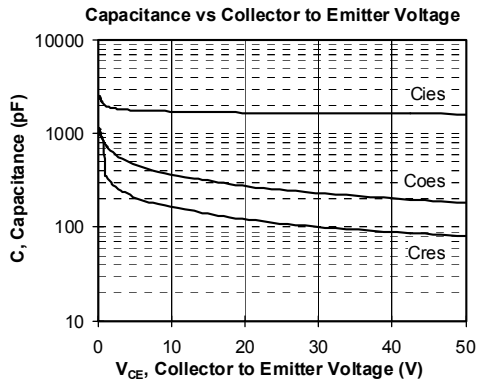

APT reserves the right to change, without notice, the specifications and information contained herein

APT's products are covered by one or more of U.S. patents 4,895,810 5,045,903 5,089,434 5,182,234 5,019,522 5,262,336 6,503,786 5,256,583 4,748,103 5,283,202 5,231,474 5,434,095 5,528,058 and foreign patents. U.S. and Foreign patents pending. All Rights Reserved.