

**ISOTOP® Buck chopper  
NPT IGBT**

**$V_{CES} = 600V$   
 $I_C = 100A @ T_c = 80^\circ C$**

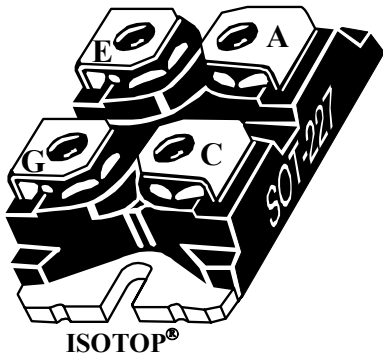
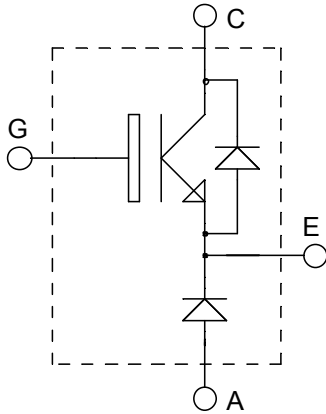

**Application**

- AC and DC motor control
- Switched Mode Power Supplies

**Features**

- Non Punch Through (NPT) THUNDERBOLT IGBT®
  - Low voltage drop
  - Low tail current
  - Switching frequency up to 100 kHz
  - Soft recovery parallel diodes
  - Low diode VF
  - Low leakage current
  - Avalanche energy rated
  - RBSOA and SCSOA rated
- ISOTOP® Package (SOT-227)
- Very low stray inductance
- High level of integration

**Benefits**

- Outstanding performance at high frequency operation
- Stable temperature behavior
- Very rugged
- Direct mounting to heatsink (isolated package)
- Low junction to case thermal resistance
- Easy paralleling due to positive TC of VCEsat

**Absolute maximum ratings**

Symbol	Parameter	Max ratings	Unit
$V_{CES}$	Collector - Emitter Breakdown Voltage	600	V
$I_{C1}$	Continuous Collector Current	$T_C = 25^\circ C$	120
$I_{C2}$		$T_C = 80^\circ C$	100
$I_{CM}$	Pulsed Collector Current	$T_C = 25^\circ C$	320
$V_{GE}$	Gate - Emitter Voltage	$\pm 20$	V
$P_D$	Maximum Power Dissipation	$T_C = 25^\circ C$	416
$I_{FAV}$	Maximum Average Forward Current	$T_C = 80^\circ C$	A
$I_{FRMS}$	RMS Forward Current (Square wave, 50% duty)		

**CAUTION:** These Devices are sensitive to Electrostatic Discharge. Proper Handling Procedures Should Be Followed.

All ratings @  $T_j = 25^\circ\text{C}$  unless otherwise specified

**Electrical Characteristics**

<i>Symbol</i>	<i>Characteristic</i>	<i>Test Conditions</i>	<i>Min</i>	<i>Typ</i>	<i>Max</i>	<i>Unit</i>
$BV_{CES}$	Collector - Emitter Breakdown Voltage	$V_{GE} = 0V, I_C = 100\mu A$	600			V
$I_{CES}$	Zero Gate Voltage Collector Current	$V_{GE} = 0V$ $V_{CE} = 600V$			100	$\mu A$
					1000	
$V_{CE(on)}$	Collector Emitter on Voltage	$V_{GE} = 15V$ $I_C = 100A$		2.0	2.5	V
				2.2		
$V_{GE(th)}$	Gate Threshold Voltage	$V_{GE} = V_{CE}, I_C = 1mA$	3		5	V
$I_{GES}$	Gate – Emitter Leakage Current	$V_{GE} = \pm 20V, V_{CE} = 0V$			$\pm 150$	nA

**Dynamic Characteristics**

<i>Symbol</i>	<i>Characteristic</i>	<i>Test Conditions</i>	<i>Min</i>	<i>Typ</i>	<i>Max</i>	<i>Unit</i>
$C_{ies}$	Input Capacitance	$V_{GE} = 0V$		4300		pF
$C_{oes}$	Output Capacitance	$V_{CE} = 25V$		470		
$C_{res}$	Reverse Transfer Capacitance	$f = 1MHz$		400		
$Q_g$	Total gate Charge	$V_{GS} = 15V$		330		nC
$Q_{ge}$	Gate – Emitter Charge	$V_{Bus} = 300V$		290		
$Q_{gc}$	Gate – Collector Charge	$I_C = 100A$		200		
$T_{d(on)}$	Turn-on Delay Time	Resistive Switching ( $25^\circ\text{C}$ )		26		ns
$T_r$	Rise Time	$V_{GE} = 15V$		25		
$T_{d(off)}$	Turn-off Delay Time	$V_{Bus} = 400V$		150		
$T_f$	Fall Time	$I_C = 100A$		30		
$E_{on}$	Turn-on Switching Energy	$R_G = 5\Omega$		3.35		
$E_{off}$	Turn off Switching Energy			2.85		
$T_{d(on)}$	Turn-on Delay Time	Inductive Switching ( $125^\circ\text{C}$ )		26		ns
$T_r$	Rise Time	$V_{GE} = 15V$		25		
$T_{d(off)}$	Turn-off Delay Time	$V_{Bus} = 400V$		170		
$T_f$	Fall Time	$I_C = 100A$		40		
$E_{on}$	Turn-on Switching Energy	$R_G = 5\Omega$		4.3		
$E_{off}$	Turn-off Switching Energy			3.5		

## Diode ratings and characteristics

Symbol	Characteristic	Test Conditions	Min	Typ	Max	Unit
V <sub>F</sub>	Diode Forward Voltage	I <sub>F</sub> = 30A		1.6	1.8	V
		I <sub>F</sub> = 60A		1.9		
		I <sub>F</sub> = 30A	T <sub>j</sub> = 125°C		1.4	
I <sub>RM</sub>	Maximum Reverse Leakage Current	V <sub>R</sub> = 600V	T <sub>j</sub> = 25°C		250	μA
		V <sub>R</sub> = 600V	T <sub>j</sub> = 125°C		500	
C <sub>T</sub>	Junction Capacitance	V <sub>R</sub> = 200V		44		pF
t <sub>rr</sub>	Reverse Recovery Time	I <sub>F</sub> = 1A, V <sub>R</sub> = 30V di/dt = 100A/μs	T <sub>j</sub> = 25°C		23	ns
	Reverse Recovery Time		T <sub>j</sub> = 25°C		85	
			T <sub>j</sub> = 125°C		160	
I <sub>RRM</sub>	Maximum Reverse Recovery Current	I <sub>F</sub> = 30A V <sub>R</sub> = 400V di/dt = 200A/μs	T <sub>j</sub> = 25°C		4	A
			T <sub>j</sub> = 125°C		8	
			T <sub>j</sub> = 25°C		130	
Q <sub>rr</sub>	Reverse Recovery Charge		T <sub>j</sub> = 125°C		700	nC
t <sub>rr</sub>	Reverse Recovery Time	I <sub>F</sub> = 30A	T <sub>j</sub> = 125°C		70	ns
Q <sub>rr</sub>	Reverse Recovery Charge	V <sub>R</sub> = 400V			1300	nC
I <sub>RRM</sub>	Maximum Reverse Recovery Current	di/dt = 1000A/μs			30	A

## Thermal and package characteristics

Symbol	Characteristic	Min	Typ	Max	Unit
R <sub>thJC</sub>	Junction to Case	IGBT		0.3	°C/W
		Diode		1.21	
R <sub>thJA</sub>	Junction to Ambient (IGBT & Diode)			20	
V <sub>ISOL</sub>	RMS Isolation Voltage, any terminal to case t = 1 min, I <sub>isol</sub> < 1mA, 50/60Hz	2500			V
T <sub>J</sub> , T <sub>STG</sub>	Storage Temperature Range	-55		150	°C
T <sub>L</sub>	Max Lead Temp for Soldering: 0.063" from case for 10 sec			300	
Torque	Mounting torque (Mounting = 8-32 or 4mm Machine and terminals = 4mm Machine)			1.5	N.m
Wt	Package Weight		29.2		g

**Typical IGBT Performance Curve**

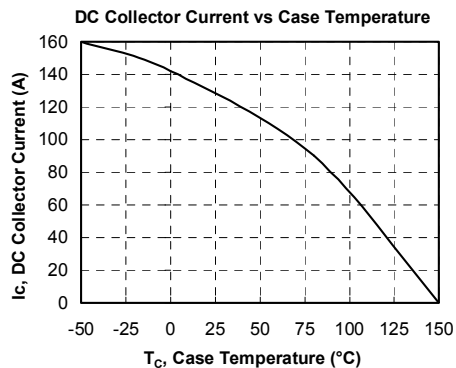
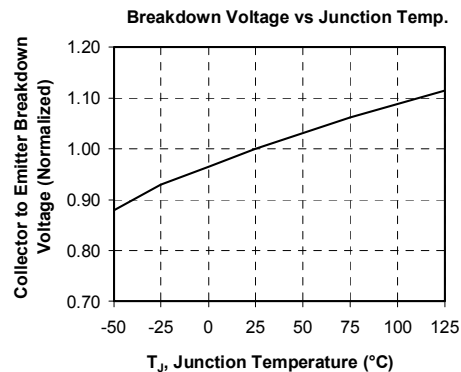
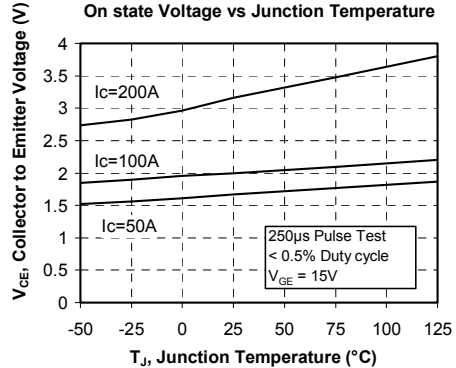
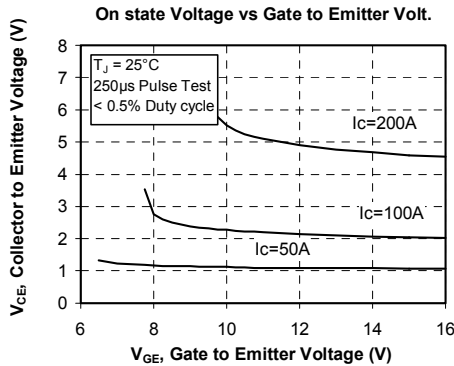
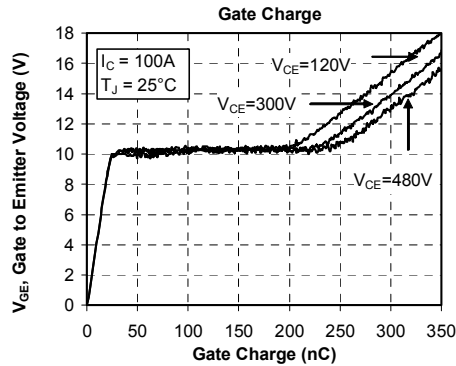
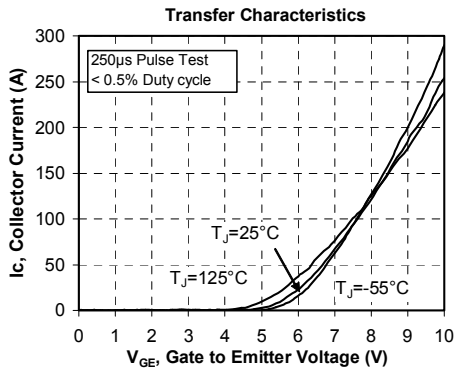
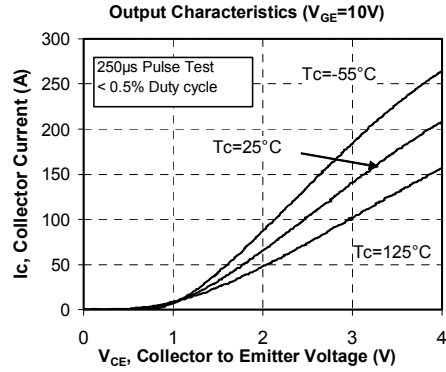
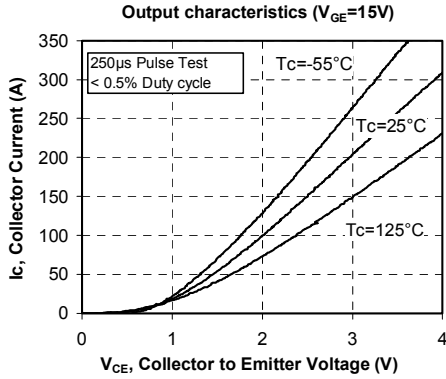

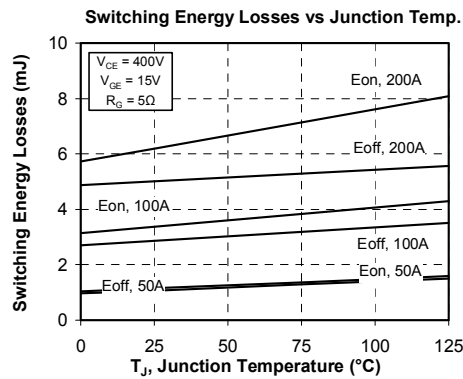
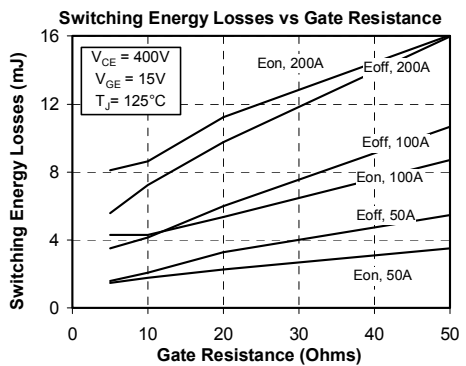
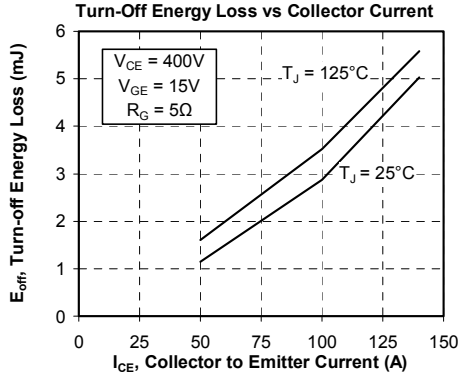
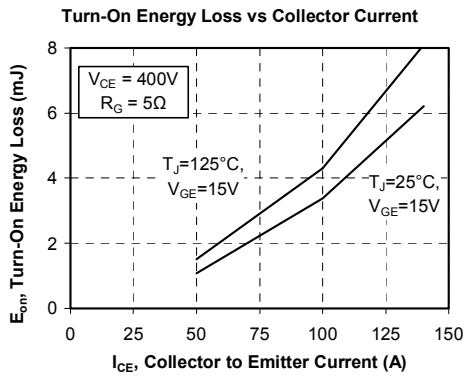
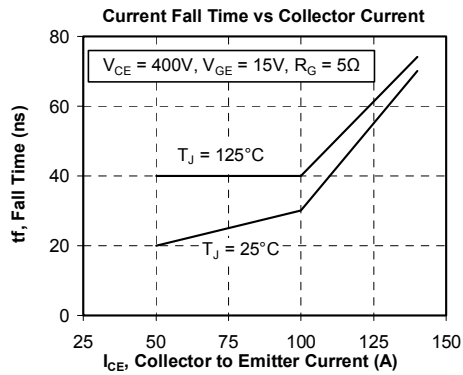
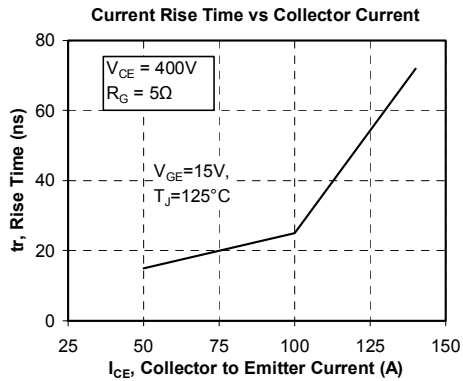
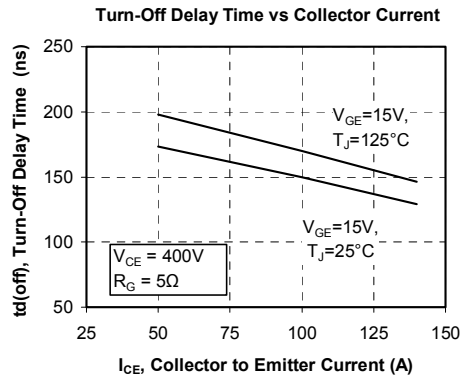
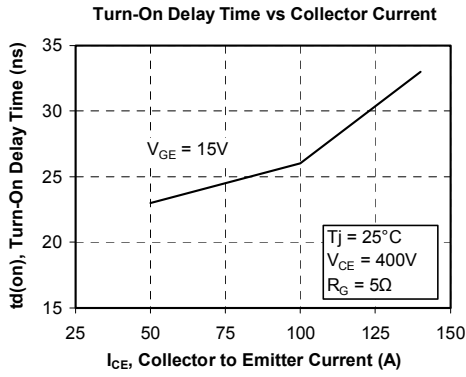

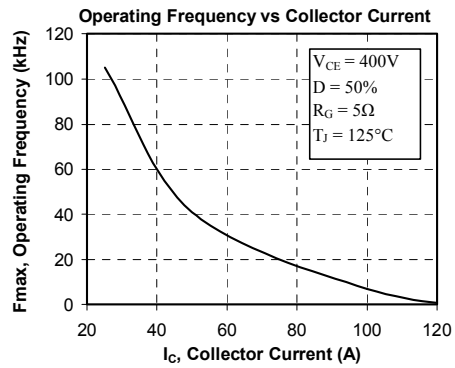
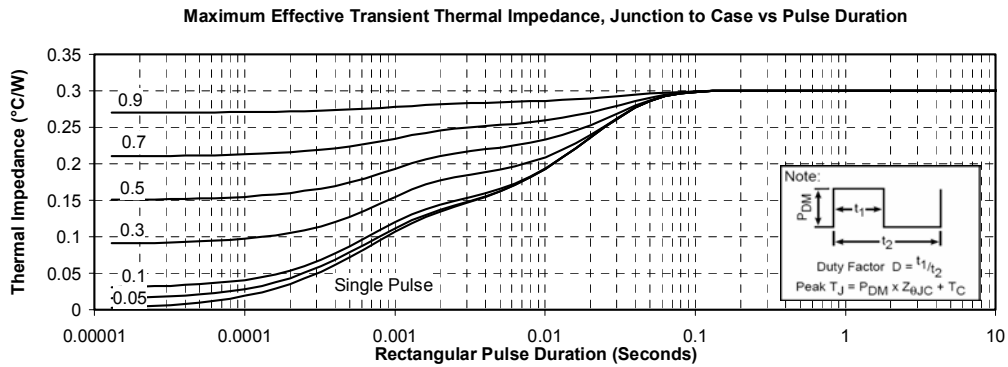
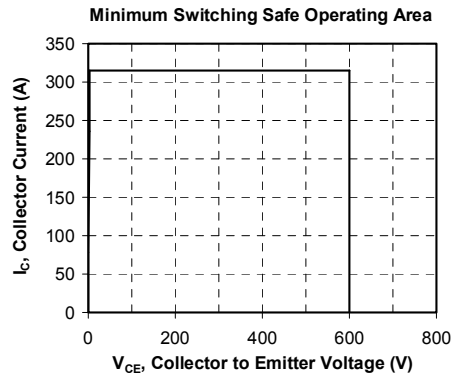
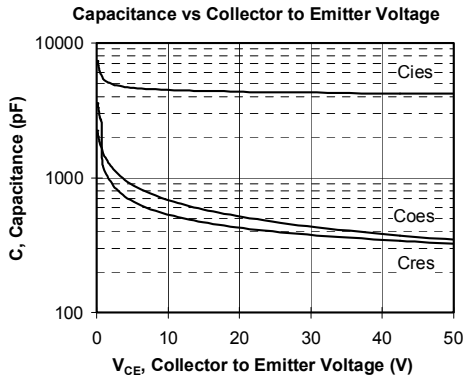

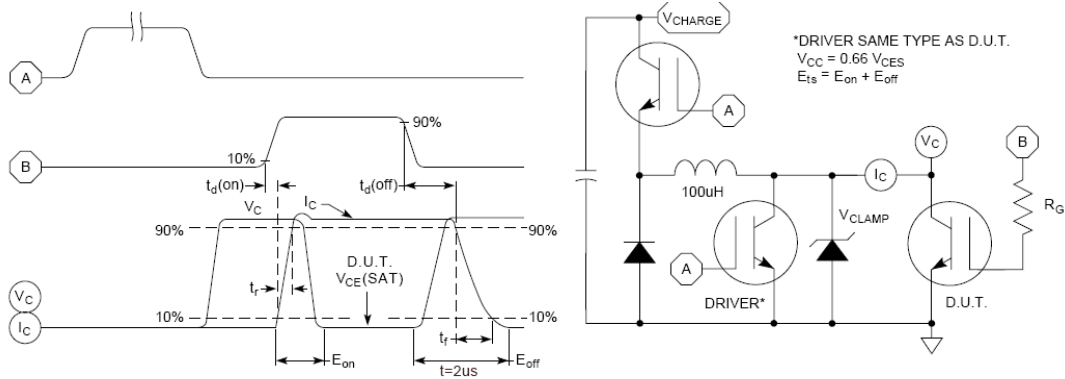

Figure 15, Switching Loss Test Circuit and Waveforms

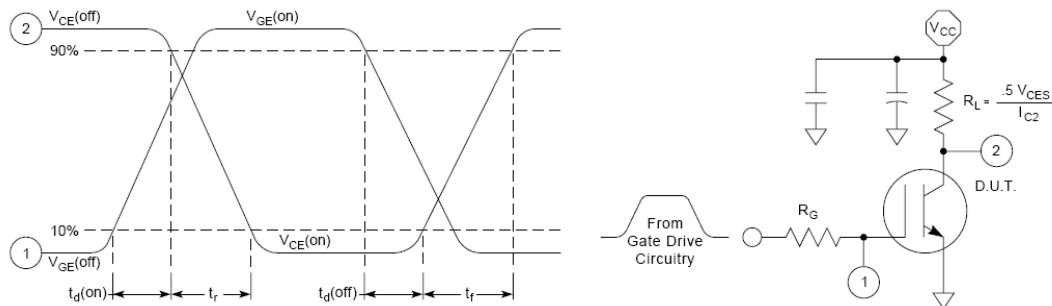

Figure 16, Resistive Switching Time Test Circuit and Waveforms

**Typical Diode Performance Curve**

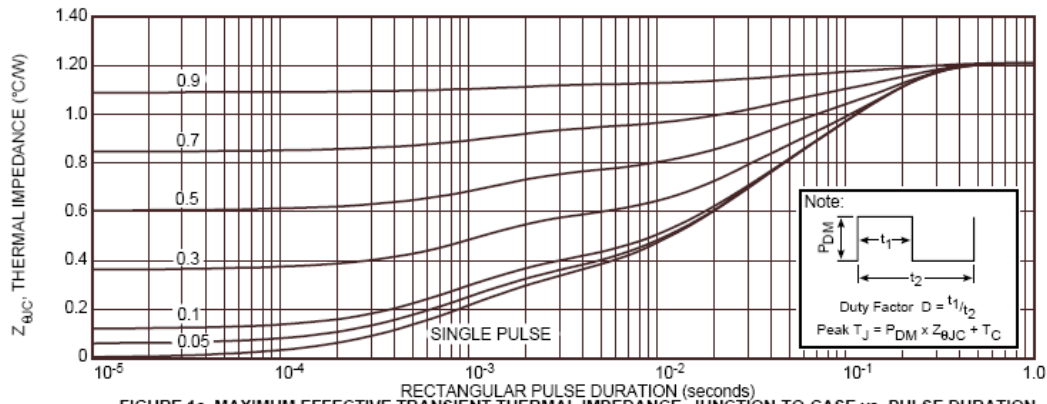

FIGURE 1a. MAXIMUM EFFECTIVE TRANSIENT THERMAL IMPEDANCE, JUNCTION-TO-CASE vs. PULSE DURATION

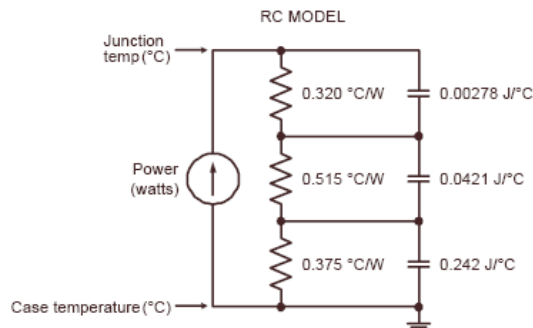

FIGURE 1b, TRANSIENT THERMAL IMPEDANCE MODEL

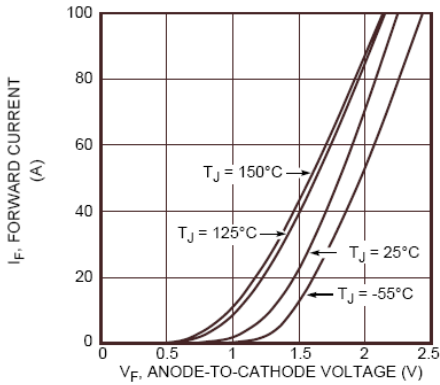

Figure 2. Forward Current vs. Forward Voltage

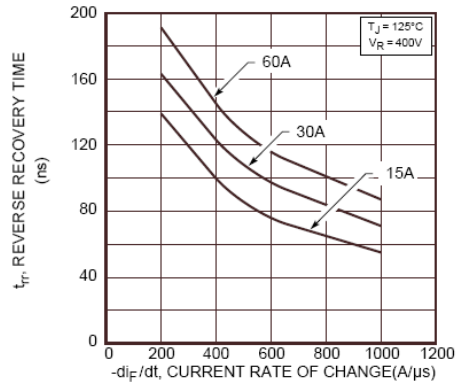

Figure 3. Reverse Recovery Time vs. Current Rate of Change

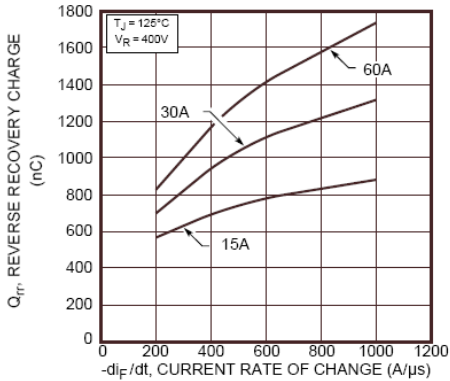

Figure 4. Reverse Recovery Charge vs. Current Rate of Change

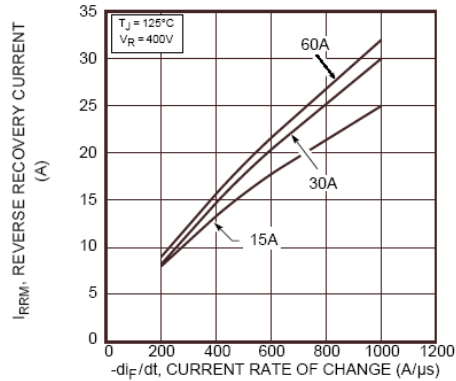

Figure 5. Reverse Recovery Current vs. Current Rate of Change

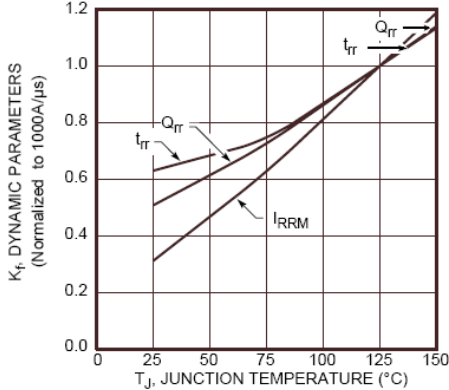

Figure 6. Dynamic Parameters vs. Junction Temperature

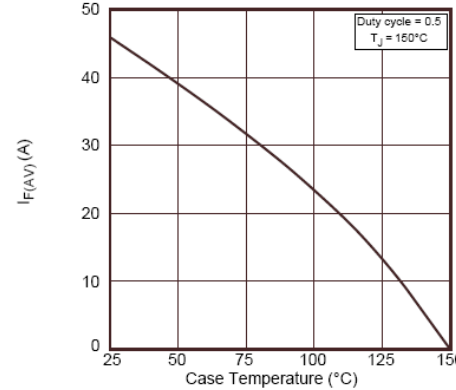

Figure 7. Maximum Average Forward Current vs. Case Temperature

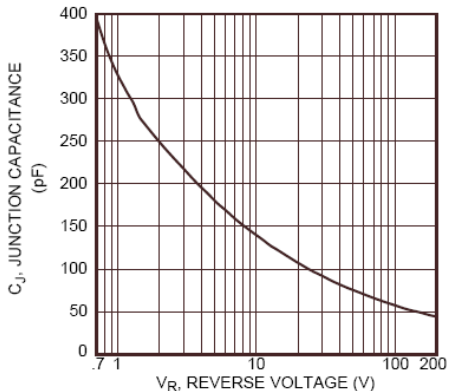

Figure 8. Junction Capacitance vs. Reverse Voltage



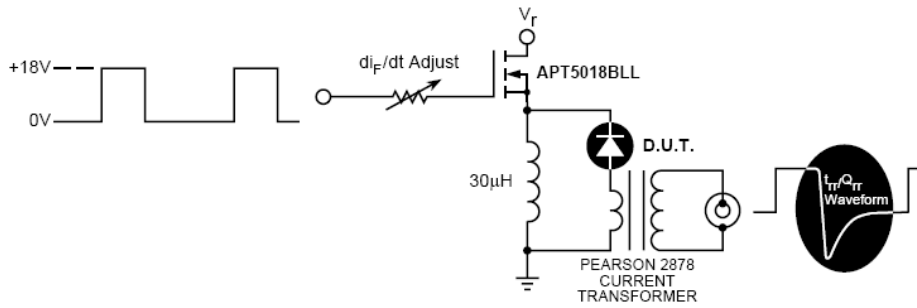

Figure 9. Diode Test Circuit

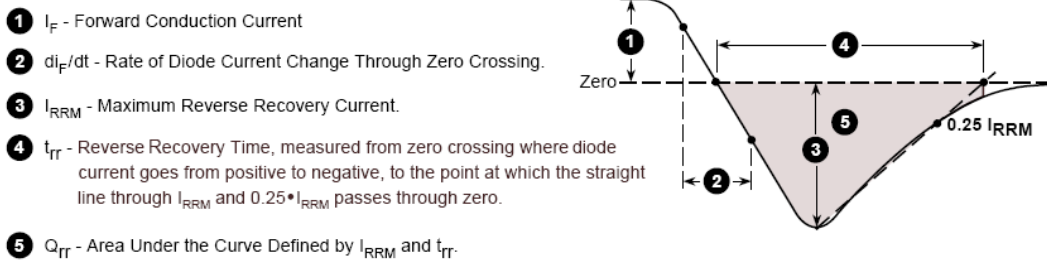
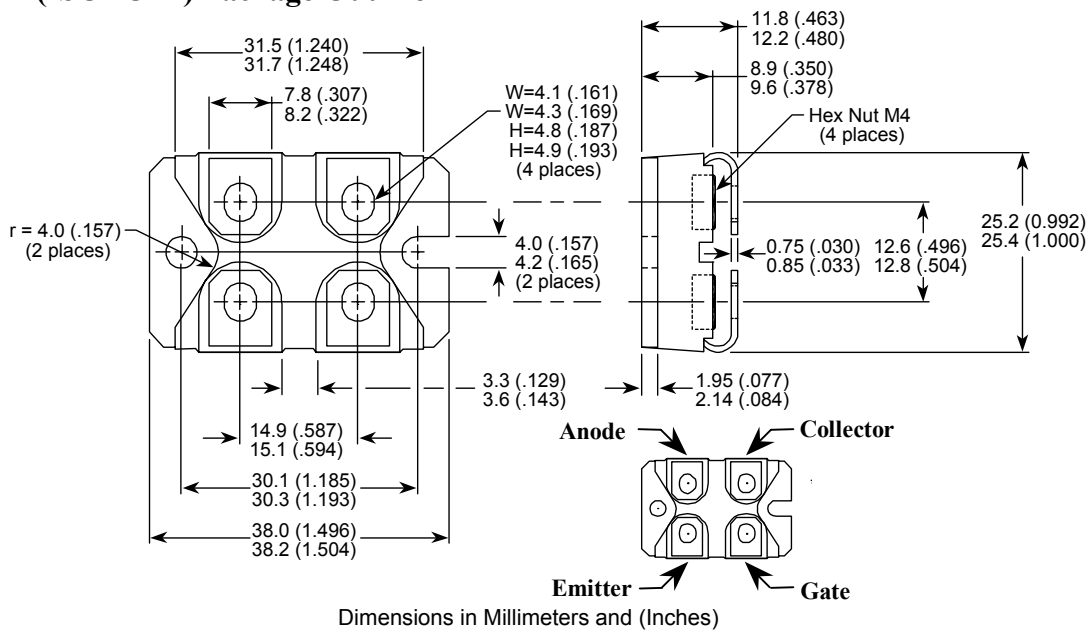

Figure 10. Diode Reverse Recovery Waveform and Definitions

**SOT-227 (ISOTOP®) Package Outline**



ISOTOP® is a Registered Trademark of SGS Thomson

APT reserves the right to change, without notice, the specifications and information contained herein

APT's products are covered by one or more of U.S. patents 4,895,810 5,045,903 5,089,434 5,182,234 5,019,522 5,262,336 6,503,786 5,256,583 4,748,103 5,283,202 5,231,474 5,434,095 5,528,058 and foreign patents. U.S. and Foreign patents pending. All Rights Reserved.